



# Vermont Pedestrian and Bicycle Facility Planning and Design Manual

Prepared for the Vermont Agency of Transportation  
by the National Center for Bicycling & Walking  
December 2002



State of Vermont  
Agency of Transportation  
1 National Life Drive  
Drawer 33  
Montpelier, VT  
05633-5001

# VTTrans

*Working to Get You There*

**OFFICE OF THE SECRETARY**

Brian R. Searles, Secretary

Phone: (802) 828-2657

Fax: (802) 828-3522

December 20, 2002

In 1991, the U.S. Congress passed landmark transportation legislation (ISTEA) that recognized the increasingly important role of bicycling and walking in our nations' transportation system. Since the passage of ISTEA (1991) and subsequently TEA-21 in 1998, Vermont's transportation plans, policies and design practices have undergone significant changes. We have begun to invest in a balanced transportation system that includes not only improvements to road and bridge infrastructure but in public transit, airports, freight and passenger rail service as well as projects that promote bicycling and walking.

Since 1991, VTTrans hired a full-time bicycle and pedestrian coordinator, initiated a Bicycle and Pedestrian Program for freestanding bike and pedestrian projects, developed the Transportation Enhancements Program which funds among other things bike and pedestrian projects, initiated safety and education training programs and fostered partnerships with the public health community. In addition agency-wide policies have been adopted that integrate bicycling and walking into the transportation mainstream.

In 1998, VTTrans adopted its first Bicycle and Pedestrian Plan which set an ambitious agenda for engaging in education, developing cooperative partnerships, streamlining the project development process and broadening the focus of the program. Development of this Design Manual was one of the tasks identified in the 1998 Plan. VTTrans continues its commitment to create walkable and bicycle-friendly communities throughout Vermont.

This Design Manual is the product of a four year effort, developed with the assistance of a project steering committee and involving extensive input from agency staff, the Federal Highway Administration, the general public and the states twelve regional planning commissions and the metropolitan planning organization. The Manual will guide the planning, design and maintenance of bicycle and pedestrian transportation facilities in Vermont into the future. Many thanks to all those who contributed to the development of this important design guidance.

Sincerely,

A handwritten signature in black ink, appearing to read "Brian R. Searles".

Brian R. Searles,  
Secretary of Transportation

[www.aot.state.vt.us](http://www.aot.state.vt.us)

Telecommunications Relay Service 1-800-253-0191

*Vermont is an Equal Opportunity Employer*

# Vermont Pedestrian and Bicycle Facility Planning and Design Manual



## Contents

<i>Acknowledgments</i> .....	v
<i>Steering Committee Members</i> .....	v
<i>Consultant Team</i> .....	v
<i>Registration Form</i> .....	vi
<i>Suggestion and Comment Form</i> .....	vii
<i>Quick Reference Conversion Chart</i> .....	viii
<i>Key Concepts and Design Summaries</i> .....	ix-xxii
<i>Chapter One</i> Introduction .....	1-1 through 1-10
<i>Chapter Two</i> Planning for Pedestrians and Bicyclists .....	2-1 through 2-26
<i>Chapter Three</i> Pedestrian Facilities .....	3-1 through 3-54
<i>Chapter Four</i> On-Road Bicycle Facilities .....	4-1 through 4-36
<i>Chapter Five</i> Shared Use Paths .....	5-1 through 5-34
<i>Chapter Six</i> Rail-Trails and Rails-With-Trails .....	6-1 through 6-20
<i>Chapter Seven</i> Traffic Calming .....	7-1 through 7-16
<i>Chapter Eight</i> Signs, Pavement Markings and Signals .....	8-2 through 8-24
<i>Chapter Nine</i> Landscaping and Amenities .....	9-1 through 9-16
<i>Chapter Ten</i> Maintenance .....	10-1 through 10-10
<i>Appendices</i>	
A: Glossary .....	A-1 through A- 6
B: AASHTO Interstate Bicycle Route Numbering Policy .....	B-1 through B-4
C: Stopping Sight Distance Charts, AASHTO Guide for the Development of Bicycle Facilities .....	C-1 through C-6

This document is also available on the VTrans website at:  
[www.aot.state.vt.us](http://www.aot.state.vt.us)

## *Acknowledgments*

Funding for this manual was provided by the Vermont Agency of Transportation in cooperation with the U.S. Department of Transportation Federal Highway Administration.

## *Steering Committee Members*

Sam Lewis, Assistant Director VTrans Project Development Division  
Jim Bush, Federal Highway Administration – VT Division Office  
Hugh Brady and Connie Livingston, City of Burlington Department of Public Works  
Nancy Rice, VTrans Rail Division  
Dan Peterson, VTrans Local Transportation Facilities Section  
Jane Brown and Paul Tober, VTrans Policy & Planning Division  
Bob Della Santa, VTrans Roadway Section  
Jay Kilton, VTrans Traffic Design Section and Maintenance Division  
Sherward Farnsworth, VTrans Structures Section  
Bob Murphy, Town Representative  
Marc Companion, General Public Representative  
Dave Pelletier, Lamoille County Planning Commission  
Dean Pierce, Wilbur Smith Associates  
Jon Kaplan, Southern Windsor County Regional Planning Commission and  
VTrans Local Transportation Facilities Section  
Amy Bell, VTrans Project Manager

## *Consultant Team*

National Center for Bicycling & Walking

Bruce Burgess, Middlebury, VT  
Nils Eddy, Bend, OR  
Bill Wilkinson, Washington, DC

Greenman Pedersen, Incorporated

Alison Church, Bennington, VT  
Pat Kenneally, Albany, NY

Graphic Solutions

Mary Alice Rath, Middlebury, VT

Rails to Trails Conservancy

Craig Della Penna, Worcester, MA

# *Vermont Agency of Transportation*

## REGISTRATION FORM



### **Vermont Pedestrian and Bicycle Facility Planning and Design Manual**

Keep your manual up to date. Use this form to register your manual. Manual updates and revisions will automatically be sent to registered users. If you have already registered an earlier version of this manual, there is no need to register again.

Name and address of your agency or organization

---

---

---

---

Your name \_\_\_\_\_

Phone \_\_\_\_\_

Fax \_\_\_\_\_

Email \_\_\_\_\_

Return to:

Vermont Agency of Transportation  
Bicycle and Pedestrian Coordinator  
Project and Development Division  
Local Transportation Facilities Section  
National Life Building  
Drawer 33  
Montpelier, VT 05633-5001  
(802) 828-5799 phone  
(802) 828-5712 fax  
amy.bell@state.vt.us (Amy Bell)  
jon.kaplan@state.vt.us (Jon Kaplan)

# *Vermont Agency of Transportation*

## SUGGESTION AND COMMENT FORM

Vermont Pedestrian and Bicycle Facility Planning and Design Manual  
December 2002

Name and address of your agency or organization

---

---

---

---

Your name \_\_\_\_\_

Phone \_\_\_\_\_

Fax \_\_\_\_\_

Email \_\_\_\_\_

Suggestions or comments (may be attached as marked up copies of pages from the manual)

---

---

---

---

---

---

---

---

Return to:

Vermont Agency of Transportation  
Bicycle and Pedestrian Coordinator  
Project and Development Division  
Local Transportation Facilities Section  
National Life Building  
Drawer 33  
Montpelier, VT 05633-5001  
(802) 828-5799 phone  
(802) 828-5712 fax  
amy.bell@state.vt.us (Amy Bell)  
jon.kaplan@state.vt.us (Jon Kaplan)

*Quick Reference Conversion Chart*

<b>Metric</b>	<b>English</b>
7 mm	0.25 in
13 mm	0.5 in
25 mm	1 in
50 mm	2 in
75 mm	3 in
100 mm	4 in
125 mm	5 in
150 mm	6 in
175 mm	7 in
200 mm	8 in
225 mm	9 in
250 mm	10 in
275 mm	11 in
300 mm	12 in
0.3 m	1 ft
0.6 m	2 ft
0.9 m	3 ft
1.2 m	4 ft
1.5 m	5 ft
1.8 m	6 ft
2.1 m	7 ft
2.4 m	8 ft
2.7 m	9 ft
3.0 m	10 ft
3.3 m	11 ft
3.6 m	12 ft
3.9 m	13 ft
4.2 m	14 ft
4.5 m	15 ft
4.8 m	16 ft
5.1 m	17 ft
5.4 m	18 ft
5.7 m	19 ft
6.0 m	20 ft
1.6 km/h	1 mph
8 km/h	5 mph
16 km/h	10 mph
24 km/h	15 mph
32 km/h	20 mph
40 km/h	25 mph
48 km/h	30 mph
56 km/h	35 mph
64 km/h	40 mph
72 km/h	45 mph
80 km/h	50 mph
88 km/h	55 mph
96 km/h	60 mph





# Key Concepts and Design Summaries

## *Chapter 1: Introduction*

### KEY CONCEPTS

- Walking and bicycling are recognized as integral components of Vermont’s transportation system.
- All transportation projects in Vermont will be designed and constructed under the assumption that they will be used by pedestrians and bicyclists (except where specifically prohibited such as on limited access highways).
- VTTrans will use this manual as the standard for development, design, construction and maintenance of pedestrian and bicycle facilities that are implemented by VTTrans or any entity using VTTrans and/or Federal-Aid Highway funds.
- This manual uses both preferred and minimum values to provide designers with the greatest possible flexibility in meeting the needs of various non-motorized users.

## *Chapter 2: Planning for Pedestrians and Bicyclists*

### KEY CONCEPTS

- Good pedestrian and bicycle facility design begins with sound planning.
- The most important design consideration in addressing pedestrian and bicycle needs is identifying the intended or “design” users for a facility. This determination is critical in guiding project design.
- Integrate pedestrian and bicycle needs into all levels of transportation planning starting at the earliest possible stage.
- Land use planning that provides compact mixed-use development is necessary to result in proximity of origins and destinations that will make walking and bicycling attractive transportation options.
- Pedestrians and bicyclists are very sensitive to indirect or out-of-direction travel. Facilities should be planned to provide the most direct, safe route possible.
- Pedestrian and bicycle planning should be closely linked with transit planning. The use and function of transit is largely dependent on the presence of adequate pedestrian facilities to provide the connection from the transit system to origins and destinations.
- The users of pedestrian and bicycle facilities will include disproportionate numbers of senior adults and children including those with a wide variety of disabilities. The safety needs of these users are an important design consideration.

## Chapter 3: Pedestrian Facilities

### KEY CONCEPTS

- A good pedestrian environment depends upon equal consideration of safety, access and aesthetics.
- Pedestrian facilities should be designed and constructed with the safety of the user in mind.
- Pedestrian facilities should provide access to desired destinations.
- A good pedestrian environment includes aesthetic design elements that result in an atmosphere that is conducive to walking.
- Discontinuous pedestrian facilities discourage use.
- The needs of people with disabilities must be considered when designing pedestrian facilities.
- For full access throughout a community, pedestrians need safe and convenient facilities both *along* (sidewalks, pathways and paved shoulders) and *across* (appropriately designed crossings and intersections) roadways.
- Pedestrians' perception of safety is greatly affected by traffic volumes and speed.
- To create pedestrian-oriented areas in downtown or village centers, it is often necessary to reduce traffic speed through roadway design features that slow traffic and through enforcement.

### DESIGN SUMMARY

#### Sidewalks and Shoulders

##### Location

##### Section 3.3.2

##### *Commercial centers and downtowns:*

- both sides of all streets.

##### *Major residential streets:*

- both sides.

##### *Local residential streets:*

- preferably both sides, but at least one side.

##### *Low-density residential (1-4 units/ac):*

- preferably both sides, but at least one side with shoulder on other side.

##### *Rural residential (less than 1 unit/ac):*

- preferably one side with shoulder on other side, but at least a shoulder on both sides.

##### Width

##### Sections 3.4.1 and 3.4.8

##### *All locations:*

- 1.5 m (5 ft) minimum

##### *Local streets outside central business district:*

- 1.8 to 2.4 m (6 to 8 ft) preferred.

##### *Commercial areas outside central business district:*

- 1.8 to 3.0 m (6 to 10 ft) preferred.

##### *Central business areas including downtowns and village centers:*

- 2.4 m to 3.0 m (8 to 10 ft) preferred.  
More width in areas of high pedestrian activity; sidewalk cafes and transit stops.

##### *Green strip between sidewalk and roadway:*

- 0.6 to 1.2 m (2 to 4 ft) on local and collector streets;
- 1.2 to 1.8 m (4 to 6 ft) on arterial and major streets;
- 1.5 to 2.4 m (5 to 8 ft) with street trees, high speeds, high truck use, or where space exists.

##### *Separation of uncurbed sidewalks:*

- 1.5 m (5 ft) minimum for uncurbed sidewalk including 0.9 m (3 ft) minimum green strip.

##### *Shoulders:*

- per Vermont State Design Standards.

##### Horizontal Clearance Sections 3.4.8 and 3.4.9

##### *Accessibility:*

- 1.5 m (5 ft) [0.9 m (3 ft) minimum] unobstructed width.
- Additional 0.6 to 0.9 m (2 to 3 ft) for shoulder-high barriers such as walls, railings and fences.

##### *Ditch or swale:*

- 0.6 m (2 ft) minimum.
- Ditch side slope should not exceed a 3:1.

##### Sidewalk Clearance

##### Section 3.4.9

- 2.4 m (8 ft) to continuous structures such as undercrossings and permanent canopies.
- 2.1 m (7 ft) to spot items such as traffic signs and tree branches.

**Surface** Sections 3.4.2, 3.4.3 and 3.4.5

- Minimum slope consistent with roadway.
- 5 percent (1:20) running slope.
- 2 percent maximum cross-slope including driveways.
- Stable, firm, and slip-resistant.
- 6 mm (0.25 in) maximum vertical change in level; 13 mm (0.5 in) if beveled.
- 13 mm (0.5 in) maximum gratings/gaps in direction of travel.
- 65 mm (2.5 in) maximum gap at rail flangeway.
- Continuity across driveways (Section 3.4.6).

**Corner Radius** Section 3.5.3

*With no turning movements:*

- 1.2 m (4 ft).

*With on-street parking or bike lanes:*

- 1.5 m (5 ft).

*On minor street with minimal truck and bus turning:*

- 4.5 to 7.5 m (15 to 25 ft).

*On major street with occasional trucks:*

- 9.0 m (30 ft).

**Curb Ramps** Section 3.5.4

- One at each crossing perpendicular to curb line.
- Within crosswalk at foot of ramp.
- No exposure to moving traffic lane.

*Maximum running slope:*

- 1:12 (8.33 percent) in new construction.
- 1:48 (2 percent) maximum cross-slope.
- 1:20 (5 percent) maximum counter-slope at gutter.
- 1:10 (10 percent) side flare slope.
- 0.9 m (3 ft) minimum width.

**Level landing at top and bottom:**

- 1.5 m (5 ft) [1.2 m (4 ft) minimum] landing length at perpendicular curb ramp.
- 1.5 m (5 ft) minimum landing length at parallel curb ramp.
- 1:48 (2%) maximum slope in the two perpendicular directions of travel.
- Flush (no lip) connection at street.
- 0.6 m (2 ft) detectable warning full width of the curb ramp.

**Crosswalks****Location** Sections 3.5.5

- All open legs of a signalized intersection.
- Across a roadway approach controlled by a STOP or a YIELD sign if there is a sidewalk or a shoulder on both sides of the approach.
- At intersections on roadway approaches not regulated by signals, STOP signs or YIELD signs if the speed limit is 60 km/h (40 mph) or less, and there are sidewalks or shoulders on both sides of the approach.
- Mid-block as needed (Section 3.5.8).
- Unmarked crossings at other intersections (Sections 3.5.5).

See also:

- Medians and Refuge Islands, Section 3.5.6.
- Slip Lanes, Section 3.5.6.
- Grade-Separated Crossings, Section 3.5.11.

**Striping** Section 3.5.5

- 2.4 m (8 ft) [1.8 m (6 ft) minimum] width.
- Extra width for high pedestrian volumes or to increase visibility of crossing.

*Block patterns:*

- 300 to 600 mm (12 to 24 in) wide stripes.
- 300 to 600 mm (12 to 24 in) stripe spacing.

*Stop lines (when used):*

- 3.0 m (10 ft) [1.2 m (4 ft) minimum] in advance.

*Curb extensions:*

- Use curb extensions with on-street parking (Section 3.4.7).
- No parking within 6 m (20 ft) from crosswalk without curb extension.

**See also:**

- Landscaping and Amenities, Chapter 9.
- Construction Zones and Temporary Access, Chapter 8, Signs, Pavement Markings and Signals, Section 8.2.5.
- Shared Use Paths, Chapter 5.

## Chapter 4: On-Road Bicycle Facilities

### KEY CONCEPTS

- To varying extent, bicycle use occurs on all highways in Vermont except for limited access highways where bicycles are legally prohibited. Therefore, all highways, except those where cyclists are legally prohibited, should be designed and constructed under the assumption that they will be used by cyclists.
- All on road facilities should be designed based on the assumption that bicyclists will be operating under the same rules of the road as motorists.
- Not all bicyclists are alike. The characteristic that best differentiates bicyclists is ability, which may be defined as a combination of skills, knowledge and judgment.
- Accommodating a wide range of bicyclists in shared roadway situations usually involves retrofitting existing highways with bicycle facilities that require 1) sharing, 2) shifting or 3) creating new roadway space.
- On-road bicycle facilities include bicycle lanes, wide curb lanes, and paved shoulders.
- Special design consideration should be paid to areas where motorists and bicyclists will be in conflict with each other. This includes driveways, curb cuts, intersections and turning lanes.

### DESIGN SUMMARY

#### Bicycle Lanes

##### Location

##### Section 4.3

##### General:

- One-way facilities not physically separated from travel lanes.

##### Urban areas and villages:

- Both sides of most highways, arterial streets and collector streets (generically referred to as “streets” below).

##### Rural areas:

- Typically not used (paved shoulders or shared lanes preferred).

##### Bridges:

- Bicycle lane preferably on roadway but may be in sidewalk area.

##### Width

##### Sections 4.3.1

##### Curbed street without on-street parking:

- 1.2 m (4 ft) minimum.
- 1.8 m (6 ft) preferred.
- 1.8 m (6 ft) where use is high, in-line skaters are expected, or grades exceed 5%.

##### Curbed street with on-street parking:

- 1.5 m (5 ft) minimum.
- 1.8 m (6 ft) preferred.
- 1.8 m (6 ft) where use is high, in-line skaters are expected, or grades exceed 5%.

##### Uncurbed street without parking:

- 1.2 m (4 ft) minimum.

- 1.5 m (5 ft) where speeds are 55 km/h (35 mph) or less.
- 1.8 m (6 ft) where use is high, in-line skaters are expected, or grades exceed 5%.
- 1.8 m (6 ft) where speeds exceed 55 km/h (35 mph).

##### Uncurbed street with parking:

- 1.5 m (5 ft) minimum.
- 1.8 m (6 ft) where speeds are 55 km/h (35 mph) or less.
- 2.1 m (7 ft) where use is high, in-line skaters are expected, or grades exceed 5%.
- 2.1 m (7 ft) where speeds exceed 55 km/h (35 mph).

##### Other Width Considerations

##### Add 0.3 m (1 ft):

- On bridges, or
- Where there are 30 or more heavy vehicles per hour in the outside lane.

##### Striping

##### Sections 4.3.2 and 4.3.4

- 150 mm (6 in.) solid white stripe standard; or (optional) 200 mm (8 in.) solid white stripe.
- On-street parking (right side of lane) marked with 100 mm (4 in.) solid white stripe or tick marks.
- Do not extend striping through intersections (except at T-intersection) and crosswalks.

- Dotted guidelines [0.6 m (2 ft) dots and 1.8 m (6 ft) spaces] may be extended through complex intersections.
- At intersections controlled by signals or stop signs and where right-turn lanes exist, use a dotted line with 0.6 m (2 ft) dots and 1.8 m (6 ft) spaces for the approach in lieu of solid striping for 15 to 60 m (50 to 200 ft).
- Where sufficient width exists, place a separate through bicycle lane between the right-turn lane and the through travel lane.
- At ramps and dedicated right-turn slip lanes, use a minimal turning radius or a compound curve to reduce entry speed.

#### Marking Section 4.3.2

- Bicycle symbol with directional arrow on pavement.
- Symbol with arrow on far side of each intersection no closer than 3–5 m (10–16 ft) from intersection; additional symbols placed periodically along uninterrupted sections. (See formula on page 4-14.)

#### Signing Section 8.3.1

- MUTCD signs R3-16 and R3-17 designate the presence of a bike lane.
- Many other signs are available for special situations; refer to MUTCD Part 9 and VTrans Standard Drawings.

#### Wide Curb Lanes Section 4.4

- Village or urban streets with insufficient width for bike lanes.
- 4.0 m (13 ft) wide without on-street parking and 4.3 m (14 ft) wide with on-street parking.
- Where 4.6 m (15 ft) or more width is available, consider striping bicycle lanes or shoulders.

#### Paved Shoulders

##### Location Section 4.5

###### *Rural:*

- Most roads and highways.

###### *Urban areas and villages:*

- Both sides of lower volume major streets where bike lanes are not appropriate.

##### Width — Not Withstanding Vermont State Design Standards Sections 4.5.1

*1.0 m (3 ft) minimum.*

*1.2 m (4 ft):*

- Against guardrail, curb or other roadside barrier.

*1.5 m (5 ft):*

- On steep up-grades where bicyclists require maneuvering room or where downgrades exceed 5% for 1 km (0.6 mi);
- Where there are 30 or more heavy vehicles per hour in the outside lane; or
- Where motor vehicle posted speeds exceed 80 km/h (50 mph).

##### Striping Section 4.5.1

- 100 mm (4 in) solid white edge line.

##### Shared Lanes Section 4.5.2

- Roads are as they exist with no special provisions for bicyclists.
- Common on neighborhood streets, low-volume (< 500 ADT) rural roads and highways, and village and downtown centers with constrained right-of-way.

#### Incremental Improvements

##### Section 4.7

*Add usable riding surface to right of roadway edge stripe by:*

- Paving extra width—as little as 0.6 m (2 ft) extra width is beneficial,
- Reducing travel lane width,
- Eliminating unneeded travel lanes, or
- Eliminating parking on one or both sides.

*Bicycle-safe drainage grates.*

*Bicycle-friendly railroad crossings.*

*Pavement surfaces free of irregularities.*

*Bicycle-oriented signs and bicycle-sensitive traffic detection devices (Chapter 8).*

*Roadway maintenance including removal of accumulated dirt, broken glass and other debris (Chapter 10).*

*Reducing and enforcing posted speed limits.*

#### See also

Shared Use Paths, *Chapter 5*

Landscaping and Amenities, *Chapter 9*

Maintenance, *Chapter 10*

## Chapter 5: Shared Use Paths

### KEY CONCEPTS

- Shared-use paths will be used by a wide variety of users including pedestrians, bicyclists, joggers, roller-bladers, people with baby-strollers and cross-country skiers and snowmobiles in the winter, where permitted.
- Shared-use paths will attract users of all ability level including less experienced bicyclists — especially children — and their design should be mindful of this fact.
- Special consideration should be given to locations where paths intersect with or terminate at a roadway.
- Shared-use paths should complement and enhance on-road pedestrian and bicycle facilities by providing connections for non-motorized travel that offer advantages over use of the regular road system (such as reducing conflicts with high speed, high volume traffic, providing a shorter distance between origins and destinations, or providing access to areas not served by streets or roads).

### DESIGN SUMMARY

#### Location

#### Section 5.1

- Within highway right-of-way or within an independent right-of-way.
- Physically separated from motorized traffic by open space or barrier.
- Shortcuts between neighborhoods, parks, schools, and business areas.
- Access to areas served only by controlled-access highways where pedestrians and bicycles are prohibited; otherwise, not a substitute for on-road facilities.
- Access to areas not well served by roads such as streams, lakes, rivers, greenways, abandoned or active railroad and utility rights of way, college campuses, and planned unit developments and community trail systems.

#### Path Design

##### Width

##### Section 5.3.2

###### *Paved shared use:*

- 3.0 to 4.3 m (10 to 14 ft) preferred [2.4 m (8 ft) minimum (rare)];
- 4.3 m (14 ft) or more with separated bicycle, horse or running lanes.

###### *Unpaved shared use:*

- 2.4 to 3.0 m (8 to 10 ft) [2.4 m (8 ft) minimum].

##### Shoulders

##### Section 5.3.2

###### *Width on both sides:*

- 0.6 m (2 ft).

###### *Slope:*

- 1:6 maximum.

#### Side Slope and Recovery Area

#### Section 5.3.2

In general, no protective barrier is required if minimum recovery area (edge of path to top of slope) is provided as follows:

- |                    |                            |
|--------------------|----------------------------|
| • 1:4 or Flatter   | No recovery area necessary |
| • 1:3              | 0.6 - 0.9 m (2-3 ft)       |
| • 1:2              | 0.9 - 1.5 m (3-5 ft)       |
| • Steeper than 1:2 | 1.5 m (5 ft) or greater    |

#### Clearance

#### Section 5.3.2

##### *Lateral from obstacles other than signs:*

- 0.6 m (2 ft) minimum.
- 0.9 m (3 ft) preferred.

##### *Vertical:*

- 3.0 m (10 ft) [2.5 m (8 ft) minimum, 3.0 m (10 ft) minimum for snowmobiles, 3.6 m (12 ft) minimum for equestrians].

#### Separation from Roadway

#### Section 5.3.2

##### *Curbed section:*

- 1.2 m (4 ft) minimum.

##### *Uncurbed section:*

- 1.5 m (5 ft) minimum, at least 0.9 m (3 ft) of which is a green strip.

#### Surface

#### Section 5.3.3

- Per VTrans Standard Sheets A-78M and A-78.
- Stable, firm, and slip-resistant.
- At unpaved roadway or driveway crossings of paved paths, pave the roadway or driveway at least 3.0 m (10 ft) on each side of crossing.

#### Grade

#### Section 5.3.4

- 5% for up to 240 m (800 ft).
- 8% for up to 90 m (300 ft).

- 11% or more for up to 15 m (50 ft).
- Running grade over 8.33% less than 30% of the total path length.

### Cross Slope Section 5.3.5

- Sloping in one direction instead of crowning preferred.

#### *Paved:*

- 2% maximum.

#### *Unpaved:*

- 5% maximum.

#### *Superelevation:*

- 2% maximum.

### Design Speed Section 5.3.7

#### *Paved:*

- 30 km/h (20 mph); 50 km/h (30 mph) for downgrades over 4% for 245 m (800 ft).

#### *Unpaved:*

- 25 km/h (15 mph).

### Barriers Section 5.3.6

#### *Purpose:*

Safety and security, protection from falls, screening of adjacent uses, separation from adjacent roadway or other uses, vertical or grade separation, or enhanced aesthetics.

#### *Need:*

Protective barrier use based on clear area, side slope steepness and material, and type of hazard.

#### *Types:*

- Fences, walls, vegetation, guardrails, jersey barrier, and railing.
- Retaining walls no closer than 0.6 m (2 ft) from path edge.
- Railings should be at least 1.1 m (3.5 ft) high.

### Crossings Section 5.3.8

#### *Marking:*

- Either none, crosswalk stripes, or dotted guidelines.

#### *Refuge island:*

- Necessary with marked crossing of more than 2 lanes.
- 3.7 m (12 ft) [2.4 m (8 ft) minimum] wide.
- Cut-through angled 30 degrees towards oncoming traffic.

### Bridges

### Section 5.3.10

#### *Width:*

- Approach width plus 0.6 m (2 ft) on each side.

#### *Vertical clearance:*

- Same as for path.

#### *Loading:*

- H10 or a 10-ton load for a two-axle vehicle.

#### *Approach railing:*

- Extend 4.5 m (15 ft) from end of bridge and flared.

#### *Decking:*

- Transverse (90 degrees to the direction of travel).

## Chapter 6: Rail-Trails and Rails-With-Trails

### KEY CONCEPTS

- Rail trails can be cost effective facilities because existing corridors and infrastructure (including grading, subbase and drainage structures) are easily adapted for non-motorized use.
- Existing and former rail lines have very moderate grades and gentle curvature that make them ideal corridors for shared use paths.
- Rail with trail projects along active rail lines require close coordination with rail operators.
- Rail trails offer a unique opportunity to incorporate educational opportunities about historical transportation patterns.

### DESIGN SUMMARY

#### Application

##### Types of Rail-Trail Corridors Section 6.1.2

###### *Active:*

- Used by freight or passenger rail.

###### *Inactive:*

- Not used for rail but still under their control; may still be tracks.

###### *Formally abandoned:*

- Abandoned by the railroad and either sold to the state or to private landowners.

###### *Railbanked:*

- Inactive corridor for interim trail use until needed for rail.

##### Historic Reference Section 6.1.4

- Past use provides historic interest, potential design theme, and community support.
- Historic structures, distance markers, and rolling stock support or complement the trail.
- Consult State Historic Preservation Office (SHPO) if there are potential historic resources.

##### Users Section 6.2.1

Besides pedestrians, bicyclists, and in-line skaters, users may include cross-country skiers, snowshoers, snowmobilers, and equestrians, as well as maintenance and emergency vehicles.

#### Rail-Trail Design

The design of rail-trails is the same as for shared use paths (Section 5.3) with the following special considerations.

##### Width Section 6.3.2

If available width is below the standard for a shared use path, consider a combination of methods to increase width:

- Locate the trail at bottom of a slope.

- Use an adjacent utility corridor.
- Widen the berm.
- Provide a timber platform adjacent to the berm.
- Use a low retaining wall to increase the width.
- Excavate the top of the berm.

##### Clearance Section 6.3.2

- For rails-with-trails, place fences, signs, landscaping, paths, or other features at least 3.3 m (11 ft) from the nearest rail face.
- Lateral clearance from objects other than signs 0.3 m (1 ft)

##### Separation Section 6.3.6

A barrier, often fencing, between a trail and active rail line.

Vegetation, grade, or a ditch may be used when:

- the trail is more than 7.6 m (25 ft) from the nearest rail face, or
- the vertical separation between the trail and the track is more than 3 m (10 ft).

##### Pavement Section and Surface Section 6.3.3

- A subbase of ballast or sub-ballast may need to be removed under some conditions.
- For unpaved rail trails, geotextile between the subbase and wearing surface may be beneficial.
- Covering tracks and ties with fill should be done only under special conditions.

##### Side Slope Section 6.3.6

If side slope exceeds the standard for a shared use path (1:4), consider a combination of methods to lessen risk of injury:

- Use forgiving materials (e.g., vegetation and grass) along steep side slopes.



- Use landscaping along the slopes of the berm to limit the extent of accidental falls.
- Eliminate the need for a railing or barrier (e.g., move trail to bottom of slope or widen berm).

## **Bridges** **Section 6.3.10**

Bridges are treated the same as for Shared Use Paths (*Section 5.3.10*) with the following special considerations:

### *Existing bridge:*

- Old rail bridge still in place and can meet trail design load with minor modifications.

### *Historical bridge:*

- Reuse of an historic bridge either in place or moved to new location. Refer to VTrans Adaptive Use Bridge Program.

### *New bridge:*

- Construction of a new bridge according to site conditions.

## Chapter 7: Traffic Calming

### KEY CONCEPTS

- The reduced motor vehicle speeds achieved through traffic calming can result in safer conditions for bicyclists and pedestrians.
- For state highways, the VTrans Traffic Calming protocol should be followed and the design of traffic calming devices should follow the guidance provided on the VTrans Standard Drawings.
- Traffic calming devices should not be isolated, but should be part of a coordinated series of traffic calming measures.
- Traffic calming is an inherently locally driven process that must be initiated by the residents of a community.

### DESIGN SUMMARY

#### Application

##### Procedure Section 7.1

- Use VTrans Traffic Calming Study and Approval Process for State Highways and VTrans Standard Drawings.
- Adopt a combination of measures throughout an area for best results.
- Use signs and pavement markings per MUTCD.

##### Goals Section 7.1.2

- Reduce speed.
- Reduce volume.
- Increase safety.
- Improve roadway environment.

#### Measures

##### Typical Measures (Vtrans Standard Drawings as applicable) Section 7.2.1

###### *Horizontal alignment:*

- Chicane (TC-3M).
- Raised median (TC-8M and TC-12M).
- Roundabout (TC-9AM and TC-9BM).
- Traffic circle (TC-5M).

###### *Vertical alignment:*

- Raised intersection (TC-6M).
- Speed hump (TC-1M).
- Speed table (TC-2M).

###### *Narrow (real or perceived):*

- Neck down (TC-4M).
- Curb extension (TC-7M).
- Curb radius reduction.
- Gateway (TC-13M).

- Landscaping (LS-1M).
- Lane width reduction.
- Raised median (TC-8M and TC-12M).
- On-street parking (TC-0).
- Pavement texture.
- Pavement markings and delineation (TC-0).

###### *Divert or block:*

- Cul de sac.
- Partial closure.

###### *Regulate and enforce:*

- 4-way stop.
- Signed turning restriction.
- Truck restriction.
- Speed reader (TC-0).

#### Impacts on Pedestrians and Bicyclists

##### Section 7.2.3

- Maintain the continuity of pedestrian and bicycling networks.
- Ensure access to destinations.
- Eliminate barriers that impede or discourage walking and bicycling.
- Reduce speed differentials between motor vehicles and other street users.

#### Roundabouts

##### Section 7.2.4

###### *Characteristics*

- Alternative to signalization when a signal may be warranted.
- VTrans Standard Sheet TC-9A for roundabout.
- VTrans Standard Sheet TC-9B for mini-roundabout.

**Accommodating Bicyclists**

- Slow the speed of motor vehicles, preferably to no more than 20 km/h (12 mph).
- Maintain operating width of the bikeway and related lane striping (where bike lanes or paved shoulders exist) up to the crosswalk.
- On shared roadways, provide adequate opportunities for merging with traffic well in advance of the roundabout.
- Do not continue the bike lane into the circulating lane of the roundabout.
- Where the opportunity exists, provide an alternate route of travel on a shared use path (not a sidewalk) adjacent to the roundabout.

**Accommodating Pedestrians**

- Use curb ramps and marked crosswalks at each leg of the roundabout about 7.6 m (25 ft) behind the entry.
- Position crosswalks to bisect splitter islands with a cut-through, curbs and detectable warnings.
- Minimize crossing distances.
- If bicycles are expected to bypass the roundabout on the adjacent sidewalk, provide width suitable for a shared use path.

## Chapter 8: Signs, Pavement Markings and Signals

### KEY CONCEPTS

- All signs, pavement markings and signals must conform to the most recent version of the Manual on Uniform Traffic Control Devices.
- Signs, pavement markings and signals should be used sparingly and only when necessary to clearly convey information to users of a bicycle or pedestrian facility.

### DESIGN SUMMARY

#### General Application Section 8.1

- Warranted by use and need per latest *Manual on Uniform Traffic Control Devices for Streets and Highways* (MUTCD).
- All signs and markings retroreflective or illuminated.

#### Pedestrian Facilities

##### Signs Section 8.2.1

*Intended for motorists:*

- Warning signs for pedestrian crossings.

*Intended for pedestrians:*

- Regulatory signs for pedestrian signals; special wayfinding signs.

*Intended for all users:*

- Most guide signs.

##### Markings Section 8.2.2

*Crosswalks:*

- Refer to Sections 3.5.5 (Crosswalks).

*Detectable warnings:*

- Refer to Section 3.5.4 (Curb Ramps).

*Vertical markers:*

- Refer to Sections 3.4.2 (Sidewalks) and 3.5.3 (Corner Radius).

##### Signals Section 8.2.3

*Timing:*

- Adult pedestrian clearance interval of 1.2 m/s (4 fps) measured from the curb-to-curb or edge-of-roadway to edge-of-roadway distance.
- Child or elderly pedestrian clearance interval of 0.9 m/s (3 fps) measured from the curb-to-curb or edge-of-roadway to edge-of-roadway distance.

Options to address slower walking speeds include:

- increase crossing time,
- decrease crossing distance,

- subdivide crossing distance (medians or refuge islands, with separate pedestrian controls), or
- provide a pedestrian-actuated control that permits extended-time crossing on demand.

*Midblock Pedestrian Activated:*

- Based on MUTCD Warrants 4 (Pedestrian Volume), 5 (School Crossing), or 7 (Crash Experience).

- Note if any potential users not reflected in the data because the lack of a signal discourages them from crossing.

*Accessibility:*

- Refer to Section 4E.06 of the MUTCD and U.S. Access Board guidelines.

##### Innovative Treatments Section 8.2.4

- In-roadway lights.
- Automated pedestrian detection.
- Countdown signals.
- Leading pedestrian interval.

#### On-Road Bicycle Facilities Section 8.3

- Most signs, pavement markings, signals, and delineators for motorists apply to bicycles.
- Part 9 of the MUTCD covers specific traffic controls for bicycles.

##### Signs Section 8.3.1

*Bike lanes:*

- MUTCD signs R3-16 and R3-17 designate the presence of a bike lane.

*Warning:*

- Signs denoting unexpected or changed conditions.

*Bicycle Route:*

- Used to guide cyclists to destinations or to mark regional, interstate and international facilities.

**Markings** **Section 8.3.2***Bike lane:*

- 150 mm (6 in.) wide retroreflectorized white stripe; and
- symbol of cyclist with directional arrow in lane.

*Object markings:*

- Delineate presence of potentially hazardous objects and obstructions.

**Signals** **Section 8.3.3***Timing:*

- Clearance interval: long enough for bicyclists who enter at end of green.
- Minimum green plus clearance interval: long enough for bicyclists who start on new green.
- Take actual field measurements prior to making adjustments.
- Use signal timing formulas (refer to section 8.3.3).

*Demand actuated signal:*

- Adjust detector sensitivity for bikes and mark most sensitive location.
- Mark pavement where sensitivity is highest.
- Consider alternatives to pavement loops (video, microwave, infrared).

*Programmable signal heads:*

- Ensure that cyclist can see signals.

*Signal synchronization:*

- Add 2 to 3 sec. to automobile green time.
- Yellow interval of 3 sec.
- All-red clearance interval greater than 2 sec.

**Shared Use Paths** **Section 8.4**

- Requires its own signing because separate alignment from roadway.
- Signs reduced size per MUTCD.
- Reduced size markings for railroad crossings.
- Supplemental markings may be used (center line, stop bar, etc.):

**School Areas** **Section 8.5**

Part 7 of the MUTCD discusses school routes, crossings, signs, markings, signals, and other considerations.

VSA Title 19, Sections 921 and 922 address school zone signs; Section 922a describes when special signs for the disabled can be installed.

## ***Chapter 9: Landscaping and Amenities***

### **KEY CONCEPTS**

- Landscape improvements should be considered in the all phases of project development with local input in the planning and design process.
- *The VT Landscape Guide for Vermont Roadways, 2001* recommends landscaping practices and prototypes suitable for urban and rural roadway conditions in Vermont as defined in the Vermont State Standards.
- Landscaping and other amenities can promote traffic calming since people tend to slow down where the roadway is more enclosed and where there are details to look at such as street trees, plantings, benches, street lighting, sidewalks, pedestrian activity and busy streets.
- Maintenance agreements with local communities, garden clubs or private landowners (where appropriate), need to be worked out in advance of construction.
- Landscape selection includes coordination for above and below ground utilities as well as safe sight distance and clear distance according to road width, travel speeds and obstacles.
- Amenities such as benches, lighting, bicycle parking, informational signing, kiosks, drinking fountains and public art enhance the non-motorized travel experience and particularly contribute to the comfort, safety, enjoyment and convenience of pedestrians and bicyclists.

## ***Chapter 10: Maintenance***

### **KEY CONCEPTS**

- The principal purpose of maintaining pedestrian and bicycle facilities is to maximize the safety and convenience of non-motorized users. A secondary purpose is to preserve and extend the useful life of these facilities.
- Design with an eye toward maintenance.
- It is essential that maintenance considerations are considered during the planning and design stages of a project to ensure that a capable maintenance entity is identified and the full cost of maintenance activities are considered.
- Develop a management plan to identify maintenance needs and responsible parties.
- Develop written maintenance procedures and follow them.
- Develop an inspection and maintenance checklist.
- Regularly monitor/inspect facilities.
- Keep a report of maintenance activities and inspections.

CHAPTER 1



# Introduction

## *Contents*

1.1	Purpose .....	1-2
1.2	Scope .....	1-3
1.3	How to Use this Manual .....	1-3
1.4	Preferred and Minimum Values .....	1-3
1.5	Relationship to Other Guides and Standards .....	1-4
1.6	Federal Funding Sources .....	1-5
1.7	Federal Design Guidance .....	1-6
1.8	Federal Policy on Pedestrian and Bicycle Accommodations and Projects .....	1-7
1.9	Federal Planning Provisions .....	1-7



East Middlebury



## *1.1 Purpose*

- **Who's expected to use this manual.**
- **Origin of this manual.**
- **Where this manual should be applied.**

The design guidance provided in this manual will assist the Vermont Agency of Transportation (VTrans), municipalities, design professionals, regional planning commissions, private developers and other design practitioners in planning, designing, constructing and maintaining pedestrian and bicycle facilities in a variety of settings throughout Vermont.

VTrans will use this manual in combination with the applicable VTrans Standard Drawings as the standard for development, design, construction and maintenance of pedestrian and bicycle facilities that are implemented by VTrans or any entity using VTrans and/or Federal-Aid Highway funds. It is recommended that this manual be used as a guide to all entities in Vermont that may be considering similar facilities.

To date there has been limited and dispersed information published about how to plan and design pedestrian and bicycle facilities, and no comprehensive design guidelines have been developed for use in a rural state such as Vermont. The guidance contained in this manual is a compilation of national and state guidance and information, which has been adapted to the context of Vermont.

This manual is a direct outgrowth of the VTrans Bicycle and Pedestrian Plan adopted in 1998, which calls for development of: "...a Vermont bicycle and pedestrian manual that will provide clear, consistent guidelines for facility design to ensure that safe, well constructed, cost effective facilities are built."

When applying this manual, pedestrian and bicycle facilities should be considered at the inception of any project and incorporated into the overall design.

This manual shows how to accommodate pedestrians and bicyclists in most environments but cannot cover all possible situations. It does not propose specific projects but offers the general principles and policies that VTrans will follow. It presents sound guidelines that will be valuable in attaining good design sensitive to the needs of pedestrians, bicyclists and other users specific to Vermont conditions.

The fundamental principle of this manual is that all transportation projects will be planned, designed and constructed under the assumption that they will be used by pedestrians and bicyclists (except where specifically prohibited such as on limited access highways). Consideration shall be given to the potential to improve walking and bicycling in all phases of transportation planning, design, reconstruction, and capacity improvement projects. Because most transportation projects in Vermont involve maintaining or improving existing infrastructure, the most likely ways in which pedestrians and bicyclists will be accommodated are to:

- retrofit the existing infrastructure, or
- piggyback on other transportation, waterline, sewer or development projects, or
- make marginal improvements, or
- incorporate innovative solutions to accommodate pedestrians and bicyclists.



In summary, this manual serves to:

- guide Vermont state, regional and local agencies in planning and developing pedestrian and bicycle networks and projects,
- inform citizens and others interested in pedestrian and bicycle transportation,
- implement the 1998 VTrans Bicycle and Pedestrian Plan, and
- provide approaches and guidelines for planning, designing and maintaining pedestrian and bicycle facilities in Vermont.

## 1.2 Scope

Walking and bicycling are recognized as integral components of Vermont's transportation system. Safe, convenient, attractive, and well-designed pedestrian and bicycle facilities are essential if these modes are to be properly accommodated and encouraged.

The recommendations in this manual are based on current state of the practice and reflect the judgment of professionals working to accommodate pedestrians and bicyclists in the planning, design, construction and maintenance of transportation facilities. In addition, this manual presents design solutions for accommodating pedestrians and bicyclists in difficult or constrained situations.

The provision of facilities — the topic on which this manual is focused — is only one element of a community's overall pedestrian and bicycle program. Conscientious planning, effective education programs, and consistent safety and law enforcement also contribute to improving our communities for pedestrians and bicyclists.

## 1.3 How This Manual Is Organized

This manual includes nine additional chapters and an appendix:

*Chapter 2* discusses planning topics and VTrans policies towards walking and bicycling including:

- The role of pedestrian and bicycle facilities in the overall transportation network.
- How to incorporate pedestrian and bicycle needs into transportation plans and project development.
- Guidance on pedestrian and bicycle master planning.

*Chapters 3 through 6* focus on pedestrian facilities, on-road bicycle facilities, shared use paths, and rail-trails, respectively. Each chapter presents general design considerations followed by recommended designs for a variety of anticipated users, conditions and traffic operation factors.

*Chapters 7 through 10* cover traffic calming, traffic control devices, landscaping, and maintenance respectively, as they relate to pedestrian and bicycle facilities.

The *Appendix* includes a glossary of terms.

## 1.4 Preferred and Minimum Values

This manual uses both preferred and minimum values to provide designers with the greatest possible flexibility in meeting the needs of various non-motorized users for a wide variety of field conditions, opportunities and constraints.

Preferred values are intended to create conditions for users that are safe and comfortable under optimum conditions. Designers should seek to meet the preferred values.



*The fundamental principle of this manual is that all transportation projects will be planned, designed and constructed under the assumption that they will be used by pedestrians and bicyclists (except where specifically prohibited such as on limited access highways)*

There are some situations where preferred values cannot be attained due to geometric, environmental or other constraints, or may not be appropriate, due to the nature of the surroundings or users. In these circumstances, a design using dimensions less than the preferred value may be acceptable. Designing to less than minimum values should be done only as a “last resort,” and the decision to do so should be well documented.

There are some minimum facility dimensions that are considered to be critical to user safety and functional use of a facility. It is acknowledged that conditions may be encountered that necessitate the use of a less than minimum dimension. When the minimum dimension cannot be provided for the following items, it will need to be approved through the VTrans Design Exception Process:

- Vertical clearance less than 2.4 m (8 ft) on a shared use path.
- Vertical clearances less than the minimum stated for highway and railroad crossings.
- Width less than 2.4 m (8 ft) for a two-way shared use path.
- Width less than 1.2 m (4 ft) for a designated bike lane.
- Clearance to fixed objects or fences less than 0.6 m (2 ft) from edge of shared use path and 0.3 (1 ft) from edge of a rail trail.

The guidelines typically include both preferred and minimum values. Where a range exists between the preferred and minimum values, intermediate values may also be used. However, a facility should not be built to less than minimum values without documentation and a formal design exception, when necessary.

Adequate documentation for designing to below minimum dimensions shall at least include the following:

1. The impact of meeting the minimum dimension (on cost, constructability, environmental resources, etc.)
2. What mitigating features or circumstances offset the use of less than minimum dimensions?

## ***1.5 Relationship to Other Guides and Standards***

This manual is the principal reference for pedestrian and bicycle facility planning and design in the State of Vermont in addition to the three documents referenced below. To the extent they are incorporated by specific reference, the latest editions of the following documents are made a part of this manual:

- 1) 23 V.S.A, § 1025 identifies the *Manual on Uniform Traffic Control Devices* (MUTCD) as the standard for all traffic control signs, signals, and markings within the state.
- 2) *Americans with Disabilities Act Accessibility Guidelines* (ADAAG). All shared use paths, sidewalks, stairways and ramps that are elements of accessible routes of travel shall be designed to provide continuous passage, and meet the requirements of ADAAG.
- 3) *The Vermont State Standards for the Design of Transportation, Construction, Reconstruction and Rehabilitation on Freeways, Roads and Streets*.

Other VTrans manuals that have a bearing on the planning and design of pedestrian and bicycle facilities include the *Engineering Operations Manual*, *Traffic De-*

*sign Manual, Road Design Manual, Pavement Management Manual and the Traffic Operations Manual.*

*VTrans Standard Drawings* should be consulted for standard design details.

*AASHTO Guide for the Development of Bicycle Facilities* provides information and sound guidelines that will be valuable in attaining good design, sensitive to the needs of both bicyclists and other highway users.

*A Policy on the Geometric Design of Highways and Streets* (also known as the AASHTO Green Book), published by the American Association of State Highway and Transportation Officials, provides additional guidance by recommending a range of values for critical dimensions, while maintaining flexibility for tailoring designs to particular situations.

*Flexibility in Highway Design*, published by the Federal Highway Administration (FHWA) as a companion to the Green Book, illustrates successful approaches and innovative thinking others have used when considering the scenic, historic, aesthetic and other cultural values, along with the safety and mobility needs, of highways.

Other resources are listed separately at the end of each chapter.

## ***1.6 Federal Funding Sources***

The passage of the Intermodal Surface Transportation Efficiency Act of 1991 (ISTEA) and the 1998 Transportation Equity Act for the 21<sup>st</sup> Century (TEA-21) resulted in significant changes in federal policy toward walking and bicycling. In passing ISTEA and TEA-21, Congress affirmed that walking and bicycling are important elements of an integrated, intermodal transportation system that provides travelers with transportation options. To ensure that their idea of an integrated, intermodal system might become reality, Congress included provisions in both pieces of legislation designed to improve conditions and safety for walking and bicycling. The latest federal transportation legislation encourages the development of pedestrian and bicycle facilities and requires consideration of pedestrian and bicycle transportation in any federally-aided transportation project.

Key provisions of ISTEA:

- Identified pedestrian walkways and bikeways as an integral part of the nation's transportation network.
- Made available significantly higher levels of federal funding for the development of bikeways to achieve various goals including: improving air quality, reducing energy costs, reducing congestion on existing roadways, and helping to lower transportation costs.
- Greatly expanded funding sources for pedestrian walkways and bicycle transportation to include nearly all of the major federal-aid highway, transit, safety and other programs, including the Surface Transportation Program (STP), the Congestion Mitigation and Air Quality (CMAQ) program and the National Highway System (NHS) program.
- Permitted Federal Lands Highway Funds to be used to construct pedestrian walkways and bicycle transportation facilities when associated with forest highways, roads and trails, park roads, parkways, public lands highways, and Indian reservation roads.
- Enabled Scenic Byways and National Recreation Trail Programs funds to be used for pedestrian and bicycle projects.

- Allowed Section 402 highway safety funds to be used for pedestrian and bicycle safety purposes.
- Broadened the scope of federally-funded transit projects to include access to transit facilities, shelters, parking areas, and facilities on transit vehicles to transport bicycles.
- Required that pedestrian walkways and bicycle facilities constructed with funds from any of the programs listed above be considered highway projects and receive the same federal/state matching share of 80-20 percent.
- Required that where federal-aid highway funds were used for bridge replacement and rehabilitation, safe bicycle facilities must be considered and built where feasible (except on fully-controlled access highways).
- Required that all state transportation departments establish a bicycle and pedestrian coordinator position to promote non-motorized vehicle use, develop facilities and promote safety programs.
- Required that all pedestrian and bicycle facilities constructed under Section 217 be located and designed according to an overall plan developed by states and metropolitan planning organizations (MPOs) and incorporated into their long-range transportation plans.

TEA-21 strengthened ISTEA provisions by requiring or permitting the following:

- In addition to previously eligible bicycle projects, NHS funds can be used for pedestrian walkways on all NHS routes.
- The ISTEA provision that restricted the use of federal-aid highway funds for bicycle facilities “where access was fully-controlled” has been eliminated.
- States and MPOs are required to give due consideration to pedestrians and bicyclists in comprehensive transportation plans developed by each MPO and state.
- States and MPOs are required to consider pedestrian walkways and bicycle transportation facilities, where appropriate, in conjunction with all new construction and reconstruction projects (except where such facilities are not permitted).
- Pedestrian and bicycle safety must be considered in all transportation plans and projects.
- The installation of safety devices such as audible traffic signals and audible signs must be considered (where appropriate).
- Educational and safety activities may now be funded with federal-aid highway funds, and new construction or reconstruction of transportation facilities should consider these types of projects where feasible.
- Clarifies that motorized wheelchairs are not motorized vehicles, thus allowing motorized wheelchairs use of pedestrian and bicycle facilities.
- Allows use of electric bicycles if permitted by state or local government regulation.
- Permits the use of hazard elimination program funds for public pedestrian and bicycle facilities.

## ***1.7 Federal Design Guidance***

In 2000, the FHWA issued *Design Guidance on Accommodating Bicycle and Pedestrian Travel* and a policy statement adopted by the United States Department of Transportation. The approach integrates bicycling and walking into the transporta-

tion mainstream with three key principles:

1. a policy statement that **bicycling and walking facilities will be incorporated into all transportation projects** unless exceptional circumstances exist;
2. an approach to achieving this policy that has already worked in State and local agencies; and
3. a series of action items that a public agency, professional association, or advocacy group can take to improve conditions for bicycling and walking.

The Policy Statement was drafted by the U.S. Department of Transportation in response to Section 1202 (b) TEA-21 with the input and assistance of public agencies, professional associations and advocacy groups.

## ***1.8 Federal Policy on Pedestrian and Bicycle Accommodations and Projects***

23 CFR, Transmittal 1 issued on December 9, 1991 by the Federal Highway Administration, sets forth policies and procedures relating to the provision of pedestrian and bicycle accommodations on federal-aid projects and federal participation in the cost of such projects.

As policy, the guidance states:

- *The safe accommodation of pedestrians and bicyclists should be given full consideration during the development of Federal-aid highway projects, and during the construction of such projects.*
- *The special needs for the elderly and the handicapped shall be considered in all Federal-aid projects that include pedestrian facilities.*
- *Where current or anticipated pedestrian and/or bicycle traffic presents a potential conflict with motor vehicle traffic, every effort shall be made to minimize the detrimental effects on all highway users who share the facility.*
- *On highways without full control of access where a bridge deck is being replaced or rehabilitated, and where bicycles are permitted to operate at each end, the bridge shall be reconstructed so that bicycles can be safely accommodated when it can be done at a reasonable cost.*
- *Consultation with local groups of organized bicyclists is to be encouraged in the development of bicycle projects.*

Regarding planning, 23 CFR 652 requires that federally aided pedestrian and bicycle projects implemented within urbanized areas be included in the transportation improvement program/annual (or biennial) element unless excluded by agreement between the state and the metropolitan planning organization.

Federally aided pedestrian and bicycle projects must be designed and constructed in accordance with the following criteria:

- *The American Association of State Highway and Transportation Officials' "Guide for Development of Bicycle Facilities," (AASHTO Guide) or equivalent guides developed in cooperation with State or local officials and acceptable to the division office of the FHWA, shall be used as standards for the construction and design of bicycle routes.*
- *Curb cuts and other provisions as may be appropriate for the handicapped are required on all Federal and Federal-aid projects involving the provision of curbs or sidewalks at all pedestrian crosswalks.*

## ***1.9 Federal Planning Provisions***

**Statewide transportation planning requirements.** 23 CFR 450.214 requires that states develop a statewide transportation plan for all areas of the state. Such plans shall:

- Be intermodal (including consideration and provision, as applicable, of elements and connections of and between rail, commercial motor vehicle, waterway, and aviation facilities, particularly with respect to intercity travel) and statewide in scope in order to facilitate the efficient movement of people and goods;
- Be reasonably consistent in time horizon among its elements, but cover a period of at least 20 years;
- Contain, as an element, a plan for bicycle transportation, pedestrian walkways and trails which is appropriately interconnected with other modes;
- Be coordinated with the metropolitan transportation plans required under 23 U.S.C. 134;
- Reference, summarize or contain any applicable short range planning studies, strategic planning and/or policy studies, transportation need studies, management system reports and any statements of policies, goals and objectives regarding issues such as transportation, economic development, housing, social and environmental effects, energy, etc., that were significant to development of the plan; and
- Reference, summarize or contain information on the availability of financial and other resources needed to carry out the plan.

In developing statewide transportation plans, states are required to:

- Cooperate with the MPOs on the portions of the plan affecting metropolitan planning areas;
- Cooperate with the Indian tribal government and the Secretary of the Interior on the portions of the plan affecting areas of the State under the jurisdiction of an Indian tribal government;
- Provide for public involvement as required under Sec. 450.212;
- Provide for substantive consideration and analysis as appropriate of specified factors as required under Sec. 450.208; and
- Provide for coordination as required under Sec. 450.210.

States are further required to provide and carry out a mechanism to establish the document, or documents, comprising the plan as the official statewide transportation plan. The plan shall be continually evaluated and periodically updated as appropriate using the procedures outlined above for development and establishment of the plan.

**Metropolitan transportation planning and programming requirements.** 23 CFR 450.322 requires that Metropolitan Planning Organizations (MPOs) also develop long range transportation plans. MPO plans are required to address at least a twenty year planning horizon. The plans need to include both long-range and short-range strategies/actions that lead to the development of an integrated intermodal transportation system that facilitates the efficient movement of people and goods. MPO transportation plans shall be reviewed and updated at least triennially in nonattainment and maintenance areas and at least every five years in attainment areas to confirm their validity and their consistency with current and forecasted transportation and land use conditions and trends. Forecast periods are also ex-

tended during reviews and updates. Finally, transportation plans must be approved by their respective MPOs.

MPO transportation plans shall:

- Identify the projected transportation demand of persons and goods in the metropolitan planning area over the period of the plan;
- Identify adopted congestion management strategies including, as appropriate, traffic operations, ride sharing, pedestrian and bicycle facilities, alternative work schedules, freight movement options, high occupancy vehicle treatments, telecommuting, and public transportation improvements (including regulatory, pricing, management, and operational options), that demonstrate a systematic approach in addressing current and future transportation demand;
- Identify pedestrian walkway and bicycle transportation facilities in accordance with 23 U.S.C. 217(g);
- Reflect the consideration given to the results of the management systems, including in TMAs that are nonattainment areas for carbon monoxide and ozone, identification of SOV projects that result from a congestion management system that meets the requirements of 23 CFR part 500;
- Assess capital investment and other measures necessary to preserve the existing transportation system (including requirements for operational improvements, resurfacing, restoration, and rehabilitation of existing and future major roadways, as well as operations, maintenance, modernization, and rehabilitation of existing and future transit facilities) and make the most efficient use of existing transportation facilities to relieve vehicular congestion and enhance the mobility of people and goods;
- Include design concept and scope descriptions of all existing and proposed transportation facilities in sufficient detail, regardless of the source of funding, in nonattainment and maintenance areas to permit conformity determinations under the U.S. EPA conformity regulations at 40 CFR part 51. In all areas, all proposed improvements shall be described in sufficient detail to develop cost estimates;
- Reflect a multimodal evaluation of the transportation, socioeconomic, environmental, and financial impact of the overall plan, including all major transportation investments in accordance with Sec. 450.318;
- For major transportation investments for which analyses are not complete, indicate that the design concept and scope (mode and alignment) have not been fully determined and will require further analysis. The plan shall identify such study corridors and subareas and may stipulate either a set of assumptions (assumed alternatives) concerning the proposed improvements or a no-build condition pending the completion of a corridor or subarea level analysis under Sec. 450.318. In nonattainment and maintenance areas, the set of assumed alternatives shall be in sufficient detail to permit plan conformity determinations under the U.S. EPA conformity regulations (40 CFR part 51);
- Reflect, to the extent that they exist, consideration of: the area's comprehensive long-range land use plan and metropolitan development objectives; national, State, and local housing goals and strategies, community development and employment plans and strategies, and environmental resource plans; local, State, and national goals and objectives such as linking low income households with employment opportunities; and the area's overall social, economic, environmental, and energy conservation goals and objectives;

- Indicate, as appropriate, proposed transportation enhancement activities as defined in 23 U.S.C. 101(a); and
- Include a financial plan that demonstrates the consistency of proposed transportation investments with already available and projected sources of revenue. The financial plan shall compare the estimated revenue from existing and proposed funding sources that can reasonably be expected to be available for transportation uses, and the estimated costs of constructing, maintaining and operating the total (existing plus planned) transportation system over the period of the plan. The estimated revenue by existing revenue source (local, State, and Federal and private) available for transportation projects shall be determined and any shortfalls identified. Proposed new revenues and/or revenue sources to cover shortfalls shall be identified, including strategies for ensuring their availability for proposed investments. Existing and proposed revenues shall cover all forecasted capital, operating, and maintenance costs. All cost and revenue projections shall be based on the data reflecting the existing situation and historical trends. For nonattainment and maintenance areas, the financial plan shall address the specific financial strategies required to ensure the implementation of projects and programs to reach air quality compliance.

MPOs shall provide adequate opportunity for public official (including elected officials) and citizen involvement in the development of the transportation plan before it is approved by the MPO, in accordance with the requirements of Sec. 450.316(b)(1). Such procedures shall include opportunities for interested parties (including citizens, affected public agencies, representatives of transportation agency employees, and private providers of transportation) to be involved in the early stages of the plan development/update process. The procedures shall include publication of the proposed plan or other methods to make it readily available for public review and comment and, in nonattainment TMAs, an opportunity for at least one formal public meeting annually to review planning assumptions and the plan development process with interested parties and the general public. The procedures also shall include publication of the approved plan or other methods to make it readily available for information purposes.

In nonattainment and maintenance areas for transportation related pollutants, the FHWA and the FTA, as well as the MPO, must make a conformity determination on any new/revised plan in accordance with the Clean Air Act and the EPA conformity regulations (40 CFR part 51).

Although transportation plans do not need to be approved by the FHWA or the FTA, copies of any new/revised plans must be provided to each agency.





CHAPTER 2

# Planning for Pedestrians and Bicyclists

## *Contents*

2.1	Overview .....	2-2
2.1.1	State .....	2-2
2.1.2	Regional .....	2-3
2.1.3	Local .....	2-3
2.1.4	Walking, Bicycling and Land Use Planning .....	2-3
2.2	Planning Principles .....	2-5
2.2.1	Responsibilities .....	2-5
2.2.2	Principles of Pedestrian and Bicycle Planning .....	2-5
2.2.3	Differences in Pedestrian and Bicycle Planning .....	2-8
2.2.4	Importance of Good Design .....	2-8
2.2.5	Importance of the Street System .....	2-8
2.3	Planning Process .....	2-8
2.4	Planning Pedestrian Facilities .....	2-10
2.4.1	VTrans Pedestrian Policy .....	2-10
2.4.2	Pedestrian Planning Strategies .....	2-12
2.4.3	Planning for Accessibility .....	2-12
2.5	Planning On-Road Bicycle Facilities .....	2-12
2.5.1	VTrans Bicycle Policy .....	2-12
2.5.2	On-Road Bicycle Facilities .....	2-14
2.5.3	Improving Conditions for Bicyclists .....	2-15
2.5.4	Bicycle Routes .....	2-17
2.6	Planning Shared Use Paths and Rail Trails .....	2-20
2.6.1	Role of Shared Use Paths .....	2-20
2.6.2	Local and Regional Connectivity .....	2-21
2.6.3	Inventory and Assessment .....	2-21
2.6.4	Planning Considerations .....	2-22
2.6.5	Special Considerations for Rails With Trails .....	2-23
2.7	Choosing an Appropriate Bicycle Facility .....	2-23
2.8	Additional Resources .....	2-26
Tables		
2-1	Pedestrians and Bicyclists Compared .....	2-7



## 2.1 Overview

Walking and bicycling are environmentally friendly modes of transportation that enhance both personal and social well being. They are also important travel modes that provide a seamless transportation system that includes other modes of transportation such as transit, commuter rail, etc. In addition to transportation, these two modes of travel provide many public access, health and economic benefits.

In addition, many of Vermont's citizens have no choice but to bicycle or walk on our roadways. For these reasons, Vermont believes it is desirable to encourage bicycling and walking through four broad goals:

1. Provide a safe, efficient and accessible transportation system designed for walking, bicycling, and public transit.
2. Ensure a healthy environment and ecosystem supported by extensive pedestrian and bicycle facilities.
3. Promote integrated transportation and land use decisions that protect and enhance human scale villages/cities/settlements, surrounded by nature and agriculture.
4. Provide for safe use of transportation corridors for walking and bicycling.

Successful pedestrian and bicycle systems are integrated into the overall transportation plan of a city, region or state and incorporate inter-modal connections. They reflect the mobility and access needs of a community, and are placed in a wider context than simple movement of people and goods. Issues such as land use, energy, health, the environment, and livability are important factors.

### 2.1.1 State

There is a strong history of activity at the state, regional and local level to support walking and bicycling opportunities. As stated in the 1998 VTrans Bicycle and Pedestrian Plan, the objectives of the VTrans Bicycle and Pedestrian Program are:

- Broaden the orientation of the bicycle and pedestrian program, including on-road facilities, off-road facilities, educational and promotion programs, facility maintenance, and consideration of pedestrian and bicycle needs within VTrans programs and project development activities.
- Allocate adequate resources and staff assistance.
- Continue working with citizen advisory committees to assist with policy and program development.
- Improve the efficiency of project development and increase local involvement in design and implementation.
- Promote pedestrian and bicycle facilities that maintain the aesthetic value and character of the existing roadway (for on-road facilities) and the scenic quality of the landscape.
- Work with regional planning entities to develop a coordinated, statewide system for pedestrian and bicycle travel.
- Focus pedestrian and bicycle needs in downtown and village centers.

### 2.1.2 Regional

Paralleling the development of pedestrian and bicycle programming, VTrans initiated its Transportation Planning Initiative (TPI) with the state's twelve Regional Planning entities including the Chittenden County Metropolitan Planning Organization (MPO) to provide broader input on the transportation programming and project selection process.

The TPI has worked to decentralize transportation decision-making and to foster regional and local input on funding and prioritization. The Regional Planning Commissions and the Metropolitan Planning Organization have been asked to include a pedestrian and bicycle element within their regional transportation plans. The regions face different challenges and they have undertaken different approaches to bicycle and pedestrian planning.

In general, regional pedestrian and bicycle planning includes:

- Inventory of existing facilities.
- Assessment of existing facility use and future need.
- List of priority facilities and improvements.
- Potential for a regional system of facilities to link with neighboring regions.
- Guidelines for site plan review to evaluate pedestrian and bicycle needs and linkages.
- Participation by pedestrian and bicycle interests on regional transportation advisory committees.

### 2.1.3 Local

Municipalities are also key partners in improving facilities for pedestrians and bicyclists. Besides building and maintaining many pedestrian and bicycle facilities on Class I town highways and local roads, municipalities control the critical zoning and subdivision ordinances that determine the character of development. Local expertise and knowledge is invaluable in planning and designing efficient, appropriate and cost-effective facilities.

Municipalities are encouraged to:

- Assess local needs for pedestrian and bicycle access and mobility.
- Build and maintain local pedestrian and bicycle facilities.
- Coordinate facility planning and development with adjacent communities and regions.
- Enact local by-laws and subdivision regulations that enhance compact settlement, and encourage walking and bicycling.
- Evaluate pedestrian and bicycle needs within site plan review and require developers to invest in pedestrian and bicycle facilities.
- Form local citizen advisory committees for pedestrian and bicycle activities.

### 2.1.4 Walking, Bicycling and Land Use Planning

Communities in many parts of the country have evolved to favor only one mode of travel — the automobile. This has occurred, in part, because land has been allowed to develop under the presumption that everyone can and will drive. As a result, communities frequently lack sidewalks, bicycle facilities and public transit, which discourages people from choosing walking or bicycling as a mode of travel.

The lack of appropriate facilities for walking and bicycling is one important reason why Americans are not as active as they could be, which, in turn, is contributing to a national health crisis. The Centers for Disease Control and Prevention (CDC)



 ***Increased bicycling and walking offers individuals and the state a host of health, social, aesthetic, environmental and transportation benefits. Supporting the needs of bicyclists and pedestrians is a central component to Vermont's movement toward a multimodal transportation system.***

– 1998 Vermont Bicycle and Pedestrian Plan

has identified physical inactivity (and related chronic health conditions of obesity, diabetes, coronary heart disease, high blood pressure, stroke, some types of cancer and gall bladder disease) as a major underlying cause of premature mortality in the United States. Much of this is because large segments of the population do not have the option of walking out their front door and being active participants in their own communities.

Fortunately, Vermont's early settlement patterns have endowed the state with an abundance of small villages and compact growth centers. Indeed, Vermont's current land use policies continues to advocate for the *growth center*, where development is concentrated in "compact village and urban centers separated by rural countryside," (Act 200, 24 VSA Section 4302(c)(1)).

Compactness and mixed use are hallmarks of a growth center. In contrast to sprawl, a compact town center minimizes its footprint and impact on surrounding land while making efficient use of infrastructure services by concentrating sewer, water, utilities, and transportation facilities. Mixed use means integrating a mixture of residential units, commercial services, employment opportunities, cultural amenities, and government uses and other destinations in close proximity to one another, thereby improving local accessibility and the viability of the center.

Because of their compactness and mixed land use characteristics, growth centers have great potential for promoting physical activity.

The CDC calls growth centers that promote physical activity "active community environments." Active community environments share these characteristics:

- Support and promote physical activity;
- Have sidewalks, on-street bicycle facilities, shared-use paths and trails, parks, open space and recreational facilities; and
- Promote mixed-use development and a connected grid of street and roads, allowing homes, employment centers, schools and stores to be easily accessed by walking and bicycling without the use of a motor vehicle.

Active community environments also share the characteristics of livable communities — cities, towns and villages where it is as easy to travel by foot, bicycle and transit as by motor vehicle. Ideally, growth centers, active community environments and livable communities are defined by these qualities:

- *Coherence* — A clear, understandable and organized sidewalk, street and land use system consistent with the scale and function of the village or city. The sidewalk and street system should link points of interest and activity, provide clean lines of sight and travel, and include simple instructive signing.
- *Continuity* — A unified pattern of pedestrian and bicycle facilities.
- *Equilibrium* — A balance among transportation modes that encourages walking, bicycling and use of transit.
- *Safety* — Protection from motor vehicles and other hazards.
- *Comfort* — Secure and negotiable walking surfaces, unobstructed passage on the sidewalk and at corners, and signals timed to enable safe and quick crossings. Roadways that provide comfortable operating conditions and widths for both bicycles and motor vehicles.
- *Sociability* — A sense of hospitality and suitability for individual and community interactions. Sidewalks should provide for many uses and activities.
- *Accessibility* — The opportunity for all individuals to walk or bicycle to all destinations.

- *Efficiency* — Simplicity and cost-effectiveness in design and function. Minimal delay along walking and bicycling routes.
- *Attractiveness* — Clean, efficient and well-maintained surroundings, with adjacent storefronts and activities that provide sidewalk interest.

In summary, it should be the aim of pedestrian and bicycle planning to provide environments that encourage walking, bicycling and a sense of community; sustain growth centers; and create opportunities for increased levels of physical activity.

## 2.2 Planning Principles

### 2.2.1 Responsibilities

Statewide and regional pedestrian and bicycle planning is carried out by the VTrans Local Transportation Facilities (LTF) Bicycle and Pedestrian Program, the VTrans Policy and Planning Division in cooperation with the state's twelve regional planning commissions and the Chittenden County Metropolitan Planning Organization. The Bicycle and Pedestrian Program helps local communities implement projects and administers state projects through a project manager assigned to each project.

Pedestrian and bicyclist needs are also routinely considered within transportation improvement projects per the VTrans Project Scoping Manual. Also, the Bicycle and Pedestrian Program coordinator and the Local Transportation Facilities program manager are permanent members of the VTrans Project Definition Team (PDT) which reviews and approves complex or costly projects.

### 2.2.2 Principles of Pedestrian and Bicycle Planning

Effective pedestrian and bicycle networks depend on:

1. Accommodating pedestrians and bicyclists on arterial and collector streets.
2. Selecting appropriate facilities.
3. Creating and maintaining a system of closely-spaced interconnected local streets.
4. Overcoming barriers such as highway crossings, intersections, railroads, and rivers.

#### Arterial and Collector Streets

Arterials and collectors are the backbone of the transportation system. Arterial and collector streets are important because they:

- Serve the mobility and access needs of the community.
- Serve the shared use needs among all transportation modes.
- Provide direct, continuous and convenient access to most destinations.
- Provide controlled crossings of other major streets.
- Bridge obstacles such as rivers, freeways and railroad tracks.

Some arterial and collector streets are often difficult for pedestrians and bicyclists to use because:

- High traffic volumes and speeds may intimidate people who want to walk or bike.
- Busy intersections are difficult for pedestrians and bicyclists to cross.
- Existing pedestrian and bicycle facilities may be absent, inadequate, discontinuous or poorly maintained.
- Local streets are often disconnected, requiring a person to take a circuitous route.

All arterials and collectors can be made more bicycle and pedestrian friendly by:

- Including pedestrian and bicycle facilities when roads are built or reconstructed.
- Retrofitting roads with bikeways and walkways, reallocating roadway space where necessary.
- Improving pedestrian crossing opportunities.
- Improving and better maintaining existing facilities.

Emphasizing arterials and collectors does not preclude making improvements on other streets or providing off-road facilities; the transportation backbone of arterials and collectors supports and depends on a complete, functional system.

### Selecting Appropriate Facilities

Well-designed pedestrian and bicycle facilities attract users. However, improving streets to make them more inviting to pedestrians and bicyclists requires that adjacent land use, traffic speeds, transit access, and street connectivity also be considered. The type of facilities usually provided are related to the character of adjacent land use:

- Rural Land Uses — typical facilities may include:
  - Shoulder bikeways or shared roadways on low-volume roads.
  - Shoulder walkways.
- Semi-Rural/Transitional Land Uses — typical facilities may include:
  - Shoulder bikeways, shared roadways, or bike lanes.
  - Sidewalks or shared use paths.
- Compact Village and Urban Land Uses — typical facilities may include:
  - Shared use paths or segments connecting otherwise discontinuous pedestrian and bicycle facilities.
  - Bike lanes on arterials and major collectors, or wide outside lanes on constrained, traffic-calmed main streets.
  - Shared roadways on minor collectors and local streets, or bike lanes where traffic speed or volume is high.
  - Sidewalks on both sides of arterials and collectors, and sidewalks on both sides of most local streets.

A discussion of how to select the most appropriate bicycle facility given the anticipated users and considering existing conditions is provided in section 2.4.4.

### Interconnected Streets

A system of interconnected streets offers direct routes with minimal out-of-direction travel. Street patterns that include cul-de-sacs and dead-end streets can require a long, circuitous route to cover a short distance, increasing out-of-direction travel for what could otherwise be a fairly short walking or bicycle trip.

To increase mobility and access for pedestrians and bicyclists, link disconnected streets together with through streets or connecting pathways.

### Barriers

Establishing pedestrian and bicycle facilities along existing streets may not be enough to fully accommodate bicycle and pedestrian travel. Major barriers should also be removed. Some common obstacles and ways to overcome them include:

- Highways, rivers and railroad tracks often divide a community if there are few crossing opportunities.

*Treatment:* Bridges or underpasses built to accommodate all modes or, if exclu-

Putney



Consider adjacent land use, traffic speeds, transit access and street connectivity when improving streets to make them more inviting to pedestrians and bicyclists.

sive bicycle-pedestrian bridges are used, located so they are visible, accessible from the existing roadway network and close to areas with high potential use.

- Wide streets can be barriers to pedestrian and bicycle cross-movement when they carry large volumes of traffic.

*Treatment:* Pedestrian crossing treatments, such as raised median islands, curb extensions or bulb outs.

- Intersections are difficult areas for pedestrians and bicyclists.

*Treatment:* Special treatments such as islands, smaller radius corners and through bike lanes.

- At-grade railroad crossings are often difficult for bicyclists to negotiate; when crossings are eliminated or improved, pedestrian and bicycle crossing opportunities are also improved.

*Treatment:* Maintain existing crossings in safe condition for bicyclists and pedestrians and where possible reduce the skew angle.

- Heavy motor vehicle traffic volumes discourage many walkers and bicyclists from using certain streets.

*Treatment:* Well-designed pedestrian and bicycle facilities will attract experienced and inexperienced users. Transportation Demand Management practices and traffic calming can help reduce traffic volumes and speeds at peak hours.

**Other References**

Additional guidance on appropriate on-road bicycle facilities can be found in the FHWA publication *Selecting Roadway Design Treatments to Accommodate Bicycles*. The selecting-roadway-design-treatment-process is based on the identification of a set of “design” bicyclists and the evaluation of a set of roadway and transportation factors which include: traffic volume, traffic speed, percent (of traffic volume) of heavy vehicles, curb conditions, parking conditions and available roadway width. Typical on-road bicycle facilities include bike lanes, wide curb or outside lanes, and paved shoulders. For an updated analysis of unit cost estimates for the various pedestrian and bicycle facilities discussed in this manual, refer to the VTrans Report on Shared Use Path and Sidewalk Unit Costs, which is available upon request from the VTrans Bicycle and Pedestrian Program staff.



*For a roadway network to serve the transportation needs of a community, it must serve all users. Pedestrian and bicycle facility planning addresses how existing and future roads can meet pedestrian bicycle needs.*

Table 2-1.  
 Pedestrians and Bicyclists Compared

SIMILARITIES	DIFFERENCES
<ul style="list-style-type: none"> <li>• Tend to be slower than motor vehicle traffic.</li> <li>• Travel near road edge in conflict with other demands such as parking, driveways, utility poles, and signs.</li> <li>• Vulnerable to weather, traffic volumes and traffic speeds.</li> <li>• Unlicensed.</li> <li>• Include wide range of ages and abilities (may include people with special needs).</li> </ul>	<ul style="list-style-type: none"> <li>• Bicyclists can travel much faster and farther than pedestrians.</li> <li>• Pedestrians are the slowest mode, can change directions quickly, and frequently stop.</li> <li>• Bicyclists can ride on roadway and follow vehicle traffic rules.</li> <li>• Pedestrians require separated facilities, special consideration at intersections and traffic signals, and a comfortable walking environment.</li> <li>• State law does not indicate how bicyclists are to be treated in a marked crosswalk.</li> </ul>

### 2.2.3 Differences in Pedestrian and Bicycle Planning

Pedestrians and bicyclists have both similarities and differences that must be considered in planning, as illustrated in Table 2-1. This section of the guide examines combined planning issues, particularly the development of multi-use trails. Later there are separate sections on pedestrian planning and bicycling planning which address their unique features.

### 2.2.4 Importance of Good Design

Well-designed pedestrian and bicycle facilities are safe, attractive, convenient, and easy to use. Inadequate facilities discourage users and unnecessary facilities waste money and resources.

Pedestrian and bicycle facilities are ideally considered at the inception of transportation projects and incorporated into the overall design, so that the needs of all modes can be coordinated.

Good design cannot solve all safety problems: enforcement and education are needed to make all road users aware of the presence of other road users.

Good design does more than provide a facility for people already walking or bicycling. Facilities that are well designed can encourage greater use of non-motorized transportation. Examples of facilities that encourage use are bike lanes, wide sidewalks with buffer strips, and traffic-calmed streets.

### 2.2.5 Importance of the Street System

Where it may be physically, financially and politically impractical to provide a new and separate network in built-up environments, the existing system of highways will often continue to serve as the backbone of pedestrian and bicycle transportation needs. For a roadway network to serve the transportation needs of a community, it must serve all users. Walkway and bikeway planning addresses how existing and future roads can meet pedestrian and bicycle needs. In planning new developments, it may be possible to incorporate a separate system of pathways, but the street system will link all destinations together.

Most walking and bicycling occurs on the existing roadway system for several reasons:

- It is already in place;
- It serves all destinations; and
- Safety can be improved when pedestrians and bicyclists are visible to motorists and they obey the same traffic laws and control devices.

## 2.3 *Planning Process*

Once a community has decided to improve conditions for pedestrians and bicyclists, the next steps involve going through a planning process. This will ensure that the broader community's needs have been considered and that individual projects meet a minimum number of hurdles as they progress towards implementation. The following is a sound process that should result in well-supported and well thought out projects regardless of how their construction will be funded. However, it will also meet the feasibility study requirements of the VTrans Bicycle and Pedestrian Program if a community is planning on using Federal funds to pay for a portion of an improvement.

There are very often two stages of planning at the community level. The first stage involves master planning that looks at bicycle and/or pedestrian needs on a



larger scale. Master planning involves the following steps:

1. Identify the area under consideration — town wide, specific neighborhood, historic village center, etc.
2. Identify pedestrian and bicycle trip generators such as concentrated residential areas, public buildings including town offices, schools, libraries, the post office and commercial attractions like grocery stores or video stores.
3. Inventory the condition of existing pedestrian and/or bicycle facilities.
4. Identify areas of particular concern relative to bicycle and pedestrian access and safety. These might be areas where pedestrians need to cross a street but no provisions exist, areas of high bicycle use with inadequate road space, areas with speeding problems, etc.
5. Map all of the information noted above.
6. Conduct public meetings to go over the findings and to find out what the public perceives as pedestrian and/or bicycle needs.
7. Identify specific areas or corridors where improvements are apparently needed.
8. Get public input on which of the areas identified in the previous step are priorities.
9. Assign some rough costs to individual improvements.

The second stage of planning involves a more detailed feasibility study of the proposed improvement that received the highest priority as a result of the master planning. For very small communities, it may not be necessary to conduct the master plan if the area is so small that there are only one or two priorities and it is clear where the needs are. Feasibility studies involve an investigation of a specific project or area and answer some of the questions that indicate whether a project can actually be permitted and constructed. Feasibility studies generally include the following steps:

1. Develop a purpose and need statement for the project. In plain terms, the purpose and need statement identifies the goals and objectives of the project by providing a description of existing conditions and explaining how they hinder the goals.
2. Identify the project area, existing conditions and proposed location of facilities. Include a discussion of other locations that were considered. Identify the origins and destinations that would be served by the proposed facility.
3. If the project will not be constructed in public right of way, identify each landowner and assess their level of interest in the project.
4. Identify existing underground and/or overhead utilities are in the project area and how they may be affected by the proposed project.
5. Identify natural and cultural resources that are in the project area and may be affected. Include an identification of constraints, possible design solutions and any necessary permits. Include resource maps indicating identified resources and the relationship to the preferred alternative. Develop a resource impact matrix for inclusion in the final report. Natural resources that should be investigated include wetlands, watercourses (lakes/ponds/streams/rivers), floodplains, threatened or endangered plant or animal species, deer or bear habitat, storm water, agricultural or forest land and hazardous wastes. Cultural resources include historic, archaeological, architectural features and public lands.



*It should be the aim of pedestrian and bicycle planning to provide environments that encourage walking, bicycling and a sense of community; sustain growth centers; and create opportunities for increased levels of physical activity.*

## *Planning for Pedestrians and Bicyclists*

6. Develop a preliminary project cost estimate that includes engineering, right of way acquisition, construction, project management and construction inspection costs. If the project is to be constructed in phases, include all of these elements for each phase.
7. Discuss anticipated maintenance needs of the proposed project, including how snow removal is to be addressed.
8. Document the extent to which the public supports the project and identify any potential problems.
9. Indicate how the proposed improvement is compatible with relevant local Town plans, Regional Transportation or Bike/Ped (if available) plans, and the VTrans Bicycle and Pedestrian Plan.
10. Provide an estimate of the time it will take to scope, design and construct the project (or the initial phase of the project).
11. Provide an assessment on the overall viability of the proposed project. Include answers to the following questions: Is the project responsive to a community need and is the public good served by spending local, state and federal dollars on this alignment? Are there other considerations that should be made before this project is advanced?

By completing this type of feasibility study, a community will get a good sense of how easy it will be to complete a project and what type of issues are likely to come up. Upon completion of the study, the community can decide whether it wants to proceed with the improvements and pursue funding from state, federal or local sources to implement the project.

It is important to note that although a sidewalk or shared use path may be seen as a benign use having little or no undue adverse effect upon the environment, this may not necessarily be the case. If a path requires that bridge abutments be constructed in a river, this has the same potential effect upon the river as if it were a roadway bridge. The undisturbed buffer area adjacent to rivers and streams is often affected by construction of a path. Although shared use paths, sidewalks and other pedestrian and bicycle facilities offer opportunities for individuals to have a direct experience with the natural world, their construction can also affect those same natural resources. Special care should be taken during the feasibility study stage to identify all potential natural and cultural resources affected by a given project.

The Vermont Agency of Natural Resources has developed a series of fact sheets that address issues that should be considered regarding the development of shared use paths. Although somewhat outdated, the sheets offer sound principals for planning and designing paths that minimize their impact on the surroundings. When using federal funds for construction, pedestrian and bicycle facilities are subject to the same environmental permits as other transportation projects.

## ***2.4 Planning Pedestrian Facilities***

### **2.4.1 VTrans Pedestrian Policy**

The 1998 VTrans Bicycle and Pedestrian Plan states:

*“The state should work to gain acceptance of walking as a legitimate and respected means of travel, and to ensure that walking is routinely considered in the transportation decision-making processes occurring at various levels of government. Pedestrian issues should become integrated into routine planning and design, as well as budgeting and funding efforts at the state, regional, and local level”*

## VTrans Pedestrian Policy

### Whereas,

- Everyone is a pedestrian;
- Walking is a part of every trip;
- Pedestrian travel is to be expected on all highways except where prohibited by state law; and
- Pedestrian travel is an integral part of the Agency's transportation program.

### **VTrans is committed to assuming a leadership role in promoting pedestrian improvement to:**

- Encourage more walking;
- Reduce the number of pedestrian-motor vehicle crashes and injuries;
- Better address walking as a mode of transportation for all residents and visitors;
- Contribute to the U.S. Department of Transportation goal by helping to double the percentage of walking in the U.S.; and
- Contribute to national health objectives by providing opportunities for walking as a matter of lifestyle through the creation of pedestrian-friendly facilities, compact growth centers and active community environments.

### **To achieve these goals, VTrans will:**

- Address pedestrian issues in all transportation plans developed with state or federal funds;
- Incorporate pedestrian facilities in all transportation projects and programs, where applicable.
- Ensure safe routes of travel for all pedestrians;
- Promote a connected network of pedestrian facilities in compact villages and urban centers;
- Enhance pedestrian mobility and safety in rural areas;
- Reinforce a sense of neighborhood and community with transportation designs that encourage pedestrian use;
- Encourage land use and transportation development that accommodate pedestrians; Enhance intermodal access for individuals with impaired mobility;
- Maintain the transportation system so pedestrian use is maximized;
- Define jurisdictional roles for providing and maintaining pedestrian facilities;
- Encourage towns and villages to use these guidelines in local planning and development; and
- Promote pedestrian safety initiatives and public awareness of the benefits that can be derived from walking.
- Improve data collection and evaluation techniques of existing and proposed facilities.

## *Planning for Pedestrians and Bicyclists*

To accomplish these objectives, and to establish and maintain a multimodal transportation system that encourages and provides for pedestrian travel, VTrans supports and subscribes to the Pedestrian Policy on page 2-11.

The realm of pedestrian planning is vast. The aim of the VTrans Pedestrian Policy is to “institutionalize” consideration of pedestrian needs into all aspects of land use and transportation planning.

### 2.4.2 Pedestrian Planning Strategies

Pedestrian facilities include paths, sidewalks, crosswalks, walkways, stairs, ramps, and building entrances. High quality pedestrian facilities should be incorporated in all compact village and urban centers. There are three general ways to implement pedestrian facilities:

- **Encourage and require pedestrian facilities in new private construction.** This can be done through comprehensive town plans, zoning ordinances, subdivision regulations and roadway design standards, as well as exactments negotiated as part of project development approval.
- **Incorporate pedestrian facilities in scheduled municipal infrastructure projects,** such as roadway and municipal utility projects.
- **Fund maintenance and spot projects through municipal sources,** local improvement districts, or property owners.

Pedestrian planning involves more than just providing and maintaining sidewalks and shared use paths. It also requires consideration of pedestrian needs in roadway design. The pedestrian environment can be enhanced with more human-scale streets in village and urban settings, lower traffic speeds, vehicular access management, smaller corner turning radii, green strips, crosswalks (particularly crosswalks with signals, curb extensions and adequate lighting), street trees, attractive parking lots, and pedestrian amenities. Traffic calming strategies, described in Chapter 7, can also significantly improve the pedestrian environment.

### 2.4.3 Planning for Accessibility

Public facilities, including walkways and roadways, must be accessible to the greatest number of people including those with physical disabilities. Many design guides and standards are available. Refer to Section 3.2.3, Accessibility, in Chapter 3, Pedestrian Facilities for detailed guidance on this topic.

## *2.5 Planning On-Road Bicycle Facilities*

### 2.5.1 VTrans Bicycle Policy

The 1998 VTrans Bicycle and Pedestrian Plan states:

*Regional bicycle...planning should include an evaluation of needed road and shoulder improvements for bicycle...accommodation. Bicycle...plans should identify the primary bicycle routes for tourists and for bicycle commuters within the regions and evaluate the needed improvements to existing shoulders based on usage and safety needs.*

*Local planners and bicyclists (including bicycle clubs and tour operators, where they exist) should be included in the route identification and planning for shoulder improvements and expansions.*

*The regional planning entities should work with VTrans District Administrators and local bicycle groups to address maintenance needs along the region's primary bicycle system.*

## VTrans Bicycle Policy

### **Whereas:**

- Bicyclists have the same mobility needs as every other user of the transportation system and use the highway system as their primary means of access to jobs, services and recreational activities;
- To varying extent, bicycles will be used on all highways except where prohibited by state law; and
- Bicycle travel is an integral part of the Agency's transportation program.

### **VTrans is committed to assuming a leadership role in promoting bicycle improvements to:**

- Encourage more bicycling;
- Reduce the number of bicycle-motor vehicle crashes and injuries;
- Better accommodate those who are dependent upon bicycling as their primary mode of transportation;
- Contribute to the U.S. Department of Transportation goal by helping to double the percentage of total trips made by bicycle in the U.S.; and
- Contribute to national health objectives of providing opportunities for bicycling as a matter of lifestyle through the creation of bicycle-friendly facilities, compact growth centers and active community environments.

### **To achieve these goals, VTrans will:**

- Address bicycling issues in all long range transportation plans developed with state or federal funds;
- Incorporate bicycle facilities in the implementation of all transportation projects and programs, where applicable.
- Design, construct and maintain all streets and highways where bicyclists are permitted under the assumption that they will be used by bicyclists;
- Promote a connected network of bicycle facilities in compact villages and urban centers;
- Enhance bicyclists' mobility and safety in rural areas;
- Reinforce a sense of neighborhood and community with transportation designs that encourage bicycle use;
- Encourage land use and transportation development that accommodate bicyclists;
- Define jurisdictional roles for the provision of bicycle facilities;
- Define jurisdictional roles for the maintenance of bicycle facilities so bicycle use is maximized;
- Encourage towns and villages to use these guidelines in local planning and development; and
- Promote bicycle safety initiatives and public awareness of the benefits that can be derived from bicycling.
- Promote improved data collection and evaluation techniques of existing and proposed facilities.

To accomplish these objectives, and to establish and maintain a multimodal transportation system that encourages and provides for bicycle travel, VTTrans supports and subscribes to the Bicycle Policy on page 2-13.

## 2.5.2 On-Road Bicycle Facilities

On-road bicycle facilities are important because they:

- Supplement a system of shared use paths, providing continuity where it otherwise might not exist.
- Increase utilitarian bicycle trips;
- Use existing infrastructure and therefore are often more cost effective than independent bicycle facilities;
- Enhance recreational opportunities; and
- Increase the bicycle share of all trips.

### Increase Utilitarian Bicycle Trips

A major goal of providing on-road bicycle facilities is to increase bicycle trips by ensuring accessibility to major destinations and by improving the comfort level of those who commute, shop and run errands by bicycle.

Compact villages and urban centers benefit most from improved bicycle (and pedestrian) transportation facilities because:

- Most people live in urban areas, including villages and rural centers;
- Developed areas have the highest concentration of origin and destination points;
- Grocery stores, shops and services are made more accessible to those without cars; and
- Average trip distances are short (typically under 5 km or 3 mi.), and short trips are the ones most easily made by bicycling or walking.

### Use Existing Infrastructure

Throughout the state, effective bicycle (and pedestrian) networks are best achieved by modifying existing roads, rather than trying to create a separate network, because:

- The street system already exists: most roads have been in place since before the widespread use of the automobile. Many resources have been dedicated to creating this system. Often, creating a totally new infrastructure for bicyclists (and pedestrians) is not financially, physically or politically feasible.
- Streets take people where they want to go. Virtually all destinations are located on a street. People bicycling (or walking) need access to these same destinations.

### Enhance Recreational Opportunities

Because people most often begin bicycling for recreation, there exists great potential for creating modal shifts from motor vehicles to bicycles by encouraging recreational bicyclists to use their bicycles for transportation. Indeed, most utilitarian bicyclists first develop cycling skills and confidence riding in traffic as recreational bicyclists. Therefore, it makes sense to enhance recreational cycling opportunities to increase the potential for transportation-oriented cycling. Similarly, providing transportation-oriented bicycle and pedestrian facilities can include these recreational benefits:

- The old-fashioned “ride around the block,” and “walk around the neighborhood,” is made possible, enhancing community cohesiveness;
- Casual bike rides can be made within the immediate vicinity of one’s home;

- Longer bike rides can start at home, avoiding the need to travel by car to a bike-friendly area;
- Facilities that have been provided primarily for recreational use (off-road paths) can be linked together to serve transportation purposes, especially where these paths provide short-cuts; and
- Rail-trail projects in populated areas can be located in corridors that serve the transportation needs of a community, as well as providing recreational benefits.

### **Increase Bicycle Share of All Trips**

It has been shown that communities that provide good bicycle networks experience high bicycle use. The 1995 Oregon Bicycle and Pedestrian Plan cites Eugene and Corvallis, Oregon, as examples of the positive effect extensive bicycle networks can have upon encouraging bicycle use.

### **2.5.3 Improving Conditions for Bicyclists**

Because bicyclists share destinations and trip purposes common to other road users, most bicycling occurs, and can be expected to occur, on major highways, roads and streets. Safety is improved when bicyclists are visible to motorists and obey the same traffic laws and control devices. A supplemental network of interconnected local streets and paths can complete the bicycle network. For maximum effectiveness, bicycle facility planning requires a two-pronged approach that includes:

1. Improving the existing transportation infrastructure for shared use of streets and roads by bicycles and motor vehicles, and
2. Integrating local streets, shared use paths and rail-trails into the bicycle network.

### **Improving the Existing Transportation Infrastructure**

Improving the existing transportation infrastructure for bicycles can help ease conflicts and delay for all modes, including cars and pedestrians. For the most part, the improvements that provide the greatest benefit are inexpensive (i.e., they can be accomplished within routine maintenance and improvement schedules). Improving the existing transportation infrastructure involves:

- Removing hazards and barriers to bicyclists;
- Providing space for both cars and bikes on major roads and calming traffic on city and village streets;
- Improving rural highways and roads; and
- Providing complementary enhancements to increase the comfort and convenience of the bicycling experience.

*Removing hazards and barriers* — Designing, constructing and retrofitting roadways to better accommodate bicycle use means eliminating basic hazards to bicycle travel. To non-cyclists, even familiar items may not appear to constitute a danger. However, the following things can be hazards and barriers to bicyclists:

- Drainage grates (refer to Section 4.9.1, Drainage and Drainage Grates).
- Railroad crossings (refer to Section 4.9.2, Railroad Crossings).
- Unresponsive traffic signals (refer to Traffic Control Devices Chapter, Section 8.3.3, Signals).
- Inadequate roadway maintenance (refer to Chapter 10 Maintenance, Section 10.5).
- Poor surface conditions (refer to Chapter 10 Maintenance, Section 10.5).

## *Planning for Pedestrians and Bicyclists*

- Busy highway crossings, large intersections and railroad tracks (refer to Section 4.9.3, Bridges and Undercrossings, and to Chapter 8, Signs, Pavement Markings and Signals).

*Improving major roads, city and village streets* — For bicyclists, cycling along major roads, while not always pleasant, has important benefits that motorists also appreciate. Major roads tend to be more direct than neighborhood streets. They are often protected by traffic-control devices at intersections and offer improved sight distance.

Skilled bicyclists usually have little trouble riding safely and cooperatively on major roads. However, less experienced bicyclists — those who comprise the greatest number of bicyclists within the population as well as those who offer the greatest potential for creating a significant modal shift from cars to bikes — prefer additional operating space. The creation of additional operating space can also offer benefits to motorists, including better accommodation of trucks, buses, other wide vehicles, and turning vehicles.

Accommodating a wide range of bicyclists in shared roadway situations usually involves retrofitting existing highways with bicycle facilities that require 1) sharing, 2) shifting or 3) creating new roadway space.

Where sharing, shifting or creating new roadway space is not feasible (such as where there may be right-of-way or environmental constraints) or appropriate (such as along local streets or in established neighborhoods), consider:

- “calming” traffic by reducing traffic speed or discouraging through traffic (refer to Chapter 7, Traffic Calming), and
- making marginal improvements (refer to Section 4.7, Incremental Improvements), improving sight distance at crossings and adding effective intersection controls (refer to Chapter 8, Signs, Pavement Markings and Signals).

### **Improving rural highways and roads**

On rural arterials and collectors, paved shoulders provide operating space for pedestrians and bicyclists as well as space for stopped and emergency vehicles. Paved shoulders also provide lateral support of subbase, base and surface courses, and thereby help to reduce maintenance costs by reducing deterioration of the edge of the roadway caused by heavy trucks and vehicles. Even when a wide shoulder is not feasible, adding as little as 0.6 m (2 ft) to the edge of the roadway can achieve the same effect. When no widening is possible, or advisable, such as along low volume local roads, conditions may be improved for all users by reducing speeds by implementing traffic calming (refer to Chapter 7—Traffic Calming), enforcing speed limits, reallocating road space by re-striping lanes to narrower widths, and increasing awareness of shared use through the judicious use of signs (refer to Section 8.3.1, Signs).

### **Providing complementary enhancements**

Bicyclists can significantly benefit from complementary enhancements that increase the comfort and convenience of the bicycling experience. Chief among the enhancements that should be considered are secure places to park bicycles at trip destinations (refer to Section 9.5.11, Bicycle Parking).

Although the majority of destinations and through routes may exist on major streets, much bicycling occurs on other facilities that offer shortcuts, less traffic or better access. These facilities — local streets, shared use paths and rail-trails — work best when they are considered part of the overall system and carefully connected to the major streets and to popular destinations.



## 2.5.4 Bicycle Routes

VTrans and municipalities may establish and maintain bicycle routes in accordance with state law as follows:

**Authority to Establish and Maintain Bicycle Routes.** VSA Title 19, Chapter 23, § 2302 states, “The agency may establish and maintain bicycle routes separately or in conjunction with the construction, reconstruction or maintenance of an existing or new highway. In so doing, the agency may use funds from any available source.”

**Authority to Adopt Rules.** VSA Title 19, Chapter 23, § 2303 states, “The secretary may adopt rules concerning the development and use of bicycle routes, pursuant to the provisions of 3 VSA Chapter 25.”

**Acquisition of Real Property.** VSA Title 19, Chapter 23, § 2305 states, “The agency [VTrans]: (1) may acquire, in accordance with the procedures of 19 VSA Chapter 5 or by gift, any real property or interest in real property that shall be necessary or appropriate for the development of bicycle routes; (2) shall assist and cooperate with regional planning commissions, municipal governments, other state agencies and citizens’ groups in the development and construction of local and regional bicycle projects and in the application for any funds available for these projects.”

**Municipal Powers.** VSA Title 19, Chapter 23, § 2307 states, “ (a) Legislative bodies of municipalities shall have the same powers granted the agency under sections 2302, 2303 and 2305 of this title relating to highways under their jurisdiction and funds appropriated to municipalities under 19 VSA § 306 (a) (5) may be used for the establishment or maintenance of bicycle routes. (b) In the construction, reconstruction, alteration or repair of bicycle routes which involves the taking of private lands, the legislative body of a municipality shall follow the procedures outlined in 19 VSA Chapter 5 or chapter 7 for the taking of private land for highways.”

**Landowner Liability.** VSA Title 19, Chapter 23, § 2309 states, “No landowner shall be liable for any property damage or personal injury sustained by any person who is using, for any purpose permitted by state law or by a municipal ordinance, bicycle routes constructed on the landowner’s property pursuant to this chapter, unless the landowner charges a fee for the use of the property.”

**Shoulder Paving Policy.** VSA Title 19, Chapter 23, § 2310 states, “ (a) Notwithstanding the provisions of section 10c of this title, it is the policy of the state to provide paved shoulders on major state highways with the intent to develop an integrated bicycle route system. This shall not apply to the interstate highway and certain other limited access highways. (b) Any construction, or reconstruction, including upgrading and resurfacing projects on these highways shall include paved shoulders unless the agency deems certain sections to be cost prohibitive.”

VTrans does not normally select and designate utilitarian bicycle routes because all highways and roads, except limited access highways are considered part of the bicycle network. However, VTrans is in the process of developing criteria for designation of long distance recreation bicycle routes. Villages, towns, cities, regions and organizations may choose to create bicycle routes to:

- *Provide directional assistance* to specific destinations, to make connections between discontinuous facilities and for recreational bicycle touring routes.
- *Identify alternate routes* to inform bicyclists about adjacent routes that may be preferable because of specific advantages such as better access, fewer hills, fewer stops, better scenery, less traffic, or avoiding a physical constraint.

Bicycle routes may be coincident with bicycle facilities such as shared use paths,

## *Planning for Pedestrians and Bicyclists*

bike lanes, wide curb lanes and paved shoulders or they may exist where no special facilities have been provided for bicycles. Bicycle routes may be identified (or “designated”) by signs or maps.

### **Selecting Bicycle Routes**

Bicycle routes and bicycle route networks are a subset of the total roadway system. By selecting and designating bicycle routes, it should not be construed that bicycle travel is to be limited only to such routes, or that other roads should not be improved for bicycle travel. AASHTO’s *Guide for the Development of Bicycle Facilities* and VTrans Bicycle Policy both state that bicycles will be ridden, to varying extents, on all streets and highways where they are permitted.

Three approaches are commonly used when selecting bicycle routes:

1. planning,
2. condition assessment, and
3. bicyclist-based.

In the *planning approach*, route selection is successively refined until a route choice emerges. Typical steps in the process include:

- Define the route objective, including origins, destinations, general corridors, service areas, network or grid size, and boundaries of the area under consideration.
- Define alignment factors (performance criteria) for the route.
- Collect data.
- Plot information on a map.
- Assess suitability of candidate routes.
- Tentatively select route and review route in the field.
- Remove or correct hazards.

The *condition assessment approach* may incorporate one of two strategies in selecting bicycle routes:

- All streets are assessed and the findings are presented to potential users in the form of a map.
- All streets or just some streets are assessed and the findings are used as a basis for recommending certain streets as bicycle routes.

Condition assessment has evolved as the most popular approach to presenting guidance information to bicyclists. Condition assessments generally use objective parameters (such as traffic volume, speed, lane width, grade, and directness) and subjective parameters (in the form of bicyclists’ observations and experience). Specialized assessments aimed at touring bicyclists may also include such factors as:

- Scenic beauty.
- Culture or uniqueness.
- Appropriate mileage.
- Accommodations.
- Meals.
- Attractions.

The *bicyclist-based approach* involves asking bicyclists to identify preferred bicycle routes. There is usually no analysis of traffic conditions, hazards or other suitability or alignment factors. It is assumed that bicyclists have intuitively taken such conditions into account in the selection of their frequently used routes. The validity of

this approach depends on how well the participating bicyclists represent the general users.

The bicyclist based-approach is particularly suited for private sector organizations interested in mapping bike routes since these groups may not have access to hard data on traffic volume, traffic mix, and lane width. The bicyclist-based approach, however, primarily results in a product that is based much more upon “desirability” of cycling on certain roads rather than on the “suitability” of those roads to accommodate all bicyclists safely regardless of skill level. The challenge for both private route planners and agency officials is to ensure that routes are both desirable and suitable.

### Designating Bicycle Routes

FHWA's *Highway Route Designation Criteria for Bicycle Routes* defines bicycle route designation as “the identification of a route for bicyclists through the use of signs, pavement markings, maps or other means.” While some state transportation agencies inseparably link designation and signing as distinguishing characteristics of bicycle routes, many designated bicycle routes have been developed by non-transportation agencies and private organizations. As a result, signs do not define the majority of designated bicycle routes.

Importantly, the U.S. Numbered Bicycle Routes Policy (Retained from June 30, 1982) promulgated by AASHTO (and included in Appendix B of this manual) defines a bicycle route as “any road, street, path or way which in some manner is specifically designated as being open to bicycle travel, regardless of whether such facilities are designated for the exclusive use of bicycles or are to be shared with other transportation modes.” This definition reflects an early 1980s AASHTO policy modification to permit states the option of using “some manner,” such as maps, to designate bicycle routes in addition to or in lieu of signs.

The usefulness of designating a route is in sharing its alignment and related support services with potential and actual users of the route. To determine whether mapping, signing, or a combination of these identification and directional systems is appropriate, a consensus among all interested parties in both the public and private sectors should be reached as to which system is preferred.

**Signs.** Bicycle routes may be designated with signs as described in Section 8.3.1, Signs, in Chapter 8, Signs, Pavement Markings and Signals. Also consult Part 9 of the Manual on Uniform Traffic Control Devices (MUTCD). Signing routes is relatively expensive and requires maintenance of signs. Only state and local government agencies may legally place signs within a roadway right-of-way.

**Maps.** Mapping is the most flexible method for communicating directional and suitability information to bicyclists given the variety of bicyclists' capabilities, trip purposes, and potential origins and destinations. Suitability maps are particularly appropriate for compact villages and urban centers. Any individual or organization willing to undertake the effort and expense may produce a bicycle route map.

### Map Types

Bicycle maps are typically either *condition* maps or *route* maps.

*Condition* maps generally cover large areas and provide empirical information concerning traffic volume and pavement or shoulder width about all or most of the roads shown on the map. The intent is to provide enough information to enable bicyclists to choose their own route among the roads available to them.

*Route* maps typically show a single route or just a few recommended routes. Route maps are usually prepared in either a multi-page, rectangular “strip” format (an outside dimension of 9 by 20 cm (3.5 by 7.75 in.) will facilitate carrying such maps in a handlebar bag) or in a single sheet format (which facilitates production and minimizes printing costs).

The advantages of using maps to convey bicycle route information include:

- The cost of producing, printing and distributing bicycle maps electronically or via hard copy can be much less than the cost of installing and maintaining signs along a route.
- Maps are one way in which the private sector may be encouraged to get involved in bicycle tourism. Information developed by the public sector may be given to any cartographic entrepreneur who would be willing to produce bicycle maps at their own expense.
- More information concerning services, points of interest, terrain and roadway conditions may be conveyed on maps than may be conveyed by pavement markings or signs.
- Maps may be produced in quantity and distributed to targeted audiences (bicycle clubs, tourists requesting information through chambers of commerce or tourism bureaus)
- Maps may be made available via the internet.
- Maps do not clutter the landscape with a proliferation of signs.

The disadvantages of using only maps to convey bicycle route information include:

- Maps have little effect toward increasing public awareness of bicycling activity or increased levels of possible bicycle activity.
- Maps become outdated quickly and may require annual updating, reprinting and distribution.

## ***2.6 Planning Shared Use Paths and Rail Trails***

### **2.6.1 Role of Shared Use Paths**

Shared use path types range from unsurfaced paths in natural areas to wider, asphalt-surfaced facilities in highly developed roadway or utility corridors. Rail trails are a unique type of shared use path that utilize former railroad corridors. Many different user groups including walkers, bicyclists, in-line skaters, scooters, baby strollers, maintenance vehicles, equestrians, and snowmobilers may use them. They are also used for many reasons including exercise, commuting, recreation, or education and may be found (or planned) in valleys, along ridges and shorelines, in village and downtown centers, and along historic routes. Shared use paths can also provide opportunities for less experienced bicyclists to bicycle away from motor vehicle traffic.

The diversity of shared use paths provides state and local transportation and recreation officials with a wide choice of facility types to satisfy the needs and wants of residents and visitors alike. However, a shared use path is not a substitute for adequate on-street facilities. Shared use paths are a complementary, non-motorized extension to the street network and should not preclude shared use of streets either by law or by design. Where pedestrian or bicycle use is prohibited on a roadway, it is imperative that convenient, alternative access to all linkages and destinations served by that roadway be provided to pedestrians and bicyclists.

Often, a primary goal of choosing to use a shared use path is the opportunity to

experience a different, and usually more natural or less developed environment, or to reach areas inaccessible to motor vehicles.

## 2.6.2 Local and Regional Connectivity

Shared use paths can be of any length from short connectors between streets to long corridors such as along rivers and lakes or former railroad corridors. A shared use path network should be integrated with other pedestrian and bicycle facilities, and connected to popular destinations, including parks, schools, colleges, employment centers, and commercial centers. Connections with the street system should be carefully designed and signed to indicate street name and path destination. A high-quality shared use trail can become the core of a regional trails system that will expand in the future.

Cooperation between jurisdictions is essential to ensure coordination of improvements and linkages for region-wide non-motorized travel modes. When a path crosses over boundaries of multiple jurisdictions (whether they be state, county, town, municipal rights-of-way, parks, or railroads) the planning, design and operation of the facility should be coordinated between jurisdictions to ensure regional connectivity and mobility for all path users.

## 2.6.3 Inventory and Assessment

After a corridor has been identified for possible development as a shared use path, planning begins with conducting a physical inventory and assessment of the natural and built features within the candidate corridor. *Trails for the Twenty-First Century*, a publication of the Rails-to-Trails Conservancy recommends the following approach for rail trails which also works well for shared use paths.

### Conduct a field investigation

During an on-site field investigation, describe and document: native elements of the landscape, the built features of the corridor, the corridor's location in relation to other major natural and developed facilities; and the route or layout of the corridor. Note areas where the corridor is compatible and in conflict with existing resources so that "opportunities" and "constraints" are identified.

### Assess opportunities and constraints

Begin an assessment with the natural features of the corridor. Note how the following elements can affect path development and how they might be modified without causing irreparable harm.

- Vegetation.
- Topography and drainage.
- Adjacent or intersecting waterways.
- Adjacent land uses.
- Significant natural features.
- Bridges.
- Tunnels.
- Canals.
- Buildings.
- Other related structures and facilities.
- Utilities.
- Domesticated animals and livestock.
- Wildlife.

- Endangered, threatened or rare species.
- Surface and subsurface composition.
- Cross-section.
- Longitudinal slope.

### 2.6.4 Planning Considerations

#### Multi Season use considerations

Where the potential exists for multi-season operation of paths, plan and design for all uses to be permitted on the path. During warm weather months, the principal users will include pedestrians and bicyclists, and possibly skaters and equestrians. In winter, path users might include cross-country skiers, snowshoers and snowmobilers. Path planning and design should seek to:

- Minimize conflicts between uses (refer to Sections 5.2.3 and 6.2.1).
- Reduce maintenance costs (refer to Section 10.7).

#### Determine access points

To encourage future path use, note points of potential access for further evaluation. Investigate the potential for access sites to serve as a trailhead (i.e., to provide parking and other facilities).

- *Parking lots.* Record the location and size of existing public parking lots and private lots where shared use by path users might be arranged (i.e. after normal office hours or during weekends for businesses or during weekdays for churches, synagogues or other similar institutions and activities).
- *Transit routes, where applicable.* Transit routes can extend the range of pedestrians and people using bicycles. Make note of all transit routes that cross the proposed corridor and look for ways to connect the transit route with the path (i.e. by providing transit stops and bicycle racks on buses).
- *Bicycle routes and facilities.* Look for opportunities where areas of increased bicycle activity, such as existing or future bicycle facilities and routes, can access the corridor.
- *Areas of pedestrian activity.* Note paths, walks and trails that intersect or lie adjacent to a corridor.
- *Generators and attractors.* Residential neighborhoods, schools, centers of employment, shopping areas, public parks, athletic fields and other areas of pedestrian activity are examples of generators and attractors that can increase path activity and benefit from path use.

#### Plan for path amenities from the outset

Anticipate what facilities may be needed at peak periods of path use. Even if they can't be constructed from the start, ample land should be set aside or additional right-of-way acquired to accommodate all amenities at build-out.

#### Group support services together

Place services requiring similar access to utilities i.e. restrooms and drinking fountains in close proximity. Grouping amenities reduces construction costs, saves path space, reduces visual clutter and increases the likelihood the services will be more easily located.

#### Create service nodes of major and minor importance

Major service nodes may include parking areas for motor vehicles; welcome centers and information kiosks; historical artifacts and interpretive displays; staging areas for equestrians, snowmobiles, skiers and bicyclists; restrooms; water fountains;

Swanton – Missisquoi Valley Rail Trail



Maps are the most efficient way to communicate directional and suitability information to bicyclists.

concession areas; restaurants and cafes; equipment outfitters and rental services; telephones; bicycle racks; cross country ski supports; picnic tables and benches; an air compressor; outdoor showers; and, where possible, access to gasoline filling stations and overnight accommodations. Locate major service nodes near more heavily used access points. If the path alignment does not come close to a major service node, consider a spur to provide that access for path users.

Minor service nodes may include sitting areas, picnic tables and benches; trash receptacles, open air shelters, and informational and interpretive signs.

### 2.6.5 Special Considerations for Rails With Trails

Where opportunities exist to develop a shared use path along an active railway, railroad companies may not enthusiastically embrace the rails-with-trails concept. From a railroad's perspective, active rail corridors are private property that is increasingly being frequented by trespassers, who are responsible for costly accidents and vandalism. Therefore, a major concern is that adjacent trails will attract even more people and bring more trouble in the form of trespassers, vandals and liability concerns. Although there is evidence that trespassing fatalities, injuries and rates have declined over the past decade, train operators report near misses daily even in well-signed areas.

The financial burden that trespassing and its effects have on railroad companies can be staggering, as most operators, if not all, are self-insured. Even when free of negligence, railroad companies may incur massive legal expense defending themselves, even if the complainant suffered a loss while trespassing. With this in mind, it is understandable why railroad companies feel no obligation at all to make it easier for people to walk and bicycle in close proximity to their property.

## 2.7 *Choosing An Appropriate Bicycle Facility*

Choosing the most appropriate bicycle facility for a given corridor is dependent on a number of factors. These include the intended user or "design bicyclist", the type of land use being served, physical and environmental constraints and the relative costs of different alternatives. While shared use paths are often perceived as the safest type of bicycle facility due to their separation from traffic, they are not always the best choice given anticipated use, existing conditions, available funding and project feasibility.

*The following step-by-step process* provides guidance to planners and designers in determining the most appropriate facility to accommodate bicyclists.

The objective is to achieve a balanced approach by providing a bicycle facility that serves the needs of the target design bicyclist group(s) as much as possible while being cognizant and sensitive to field conditions and the needs of other roadway users including pedestrians and motorists.

#### ***Step 1. Develop a coalition of supporters for the improvement.***

Seek out the expertise at the town, regional planning commission/metropolitan planning organization and VTrans level. Move forward with acquiring funds and, if necessary, hire a consultant to assist with the other steps of this process.

#### ***Step 2. Identify roadway segments targeted for improvement for bicyclists.***

Make note of useful information including (if available) name or number of route segment, beginning and ending mile markers, where route segment starts, where

## Planning for Pedestrians and Bicyclists

### Group A — Advanced Bicyclists

These bicyclists exhibit the following characteristics:

- Experienced riders.
- Have a level of comfort operating in traffic conditions.
- Use existing roadway system.
- Operate at maximum speed with minimum delay.
- Require minimal operating space on the roadway or shoulder to reduce the need for either the bicyclist or the motor vehicle operator to change position when passing.

### Group B — Basic Bicyclists

Group B bicyclists exhibit the following characteristics:

- Casual or new adult or teen-age riders.
- Less confident of their ability to operate in traffic without special provisions for bicycles.
- Some will become advanced bicyclists, most will remain basic riders.
- Prefer low-speed, low traffic-volume streets or designated bicycle facilities.

### Group C — Children

The bicycle riders that comprise Group C share these traits:

- Children, usually pre-teen riders.
- Roadway use initially monitored by parents.
- May not comply with traffic regulations.
- They (and their parents) prefer residential streets with low motor vehicle volumes and speed limits, and well-defined separation of bicycles and motor vehicles or separate pathways.

route segment ends, jurisdiction where segment is located, and length of the segment in kilometers or miles.

**Step 3. Identify the design bicyclist group(s) for whom the facility is to be designed. See Chapter 4 for a thorough discussion of design bicyclists.**

The classifications of design bicyclists are based on the different levels of experience and skill among bicyclists. Group A bicyclists are the most experienced and can operate under most traffic conditions. Group B and C bicyclists include children and new or casual riders who are less confident or able to operate in a range of traffic conditions. Additionally, Group C bicyclists in the younger age groups do not have the developmental ability to safely judge complex traffic situations such as crossing roads.

When selecting the design bicyclist, consideration should be given to the type of land uses that will be served by the facility. For example, if a corridor being evaluated connects a residential neighborhood with an elementary school, it is likely that the majority of bicyclists using the corridor will be child (Group C) bicyclists. It should be acknowledged that regardless of the design bicyclist chosen, it is likely that bicyclists of all abilities will end up using a facility.

**Step 4. Determine whether the improvements will likely be part of new construction or reconstruction or resurfacing of an existing roadway or other transportation improvements (retrofitting) within a transportation corridor.**

When a new road is constructed or an existing road reconstructed or resurfaced, provisions for bicyclists should be included that meet the minimum dimensions as outlined in this manual and the VT State Standards. If an existing road is being retrofitted to better serve bicyclists, it is likely that some type of on-road facility can be included by reallocating existing roadway space. Shared use paths can also be used to improve bicycle access and safety within a corridor as part of new construction, reconstruction or in a retrofit situation.

**Step 5. Visit the project area and inventory existing conditions for each roadway segment.**

Collect the following on-site data:

- Existing bicycle and pedestrian activity along the study segment.
- Existing roadway widths including travel lanes, shoulders, parking lanes, sidewalks, curbs, etc.
- Any physical roadway right-of-way or property boundary monumentation.
- Location of above and underground utilities, sidewalks, signs, traffic signal controller boxes, strain poles and other objects that may occur within or adjacent to the road right-of-way and may restrict improvements.
- Existing posted speed for motor vehicles or prevailing speed based on a speed study.
- Adjacent land use. Pay special attention to land uses that could create special concerns for bicyclists such as industrial areas that generate heavy truck traffic or commercial areas where entrance and exit activity is especially pronounced.
- Number and location of access points (curb cuts, etc.) on each side of the roadway.
- Identify constrained areas or potentially hazardous features such as bridges, rock outcroppings, diminished widths, railroad crossings, etc.
- Identify barriers and hazards (railroad tracks, rivers, farm entrances, broken pavement, apparent lack of maintenance, etc.)



**Step 6. Collect the following record data.**

- Motor vehicle traffic volume (AADT)
- Data from any speed studies that may have been conducted
- Volume of trucks as a percent of AADT.
- Existing engineering drawings of the corridor (if available)
- Documentation of existing right-of-way width

**Step 7. Determine whether the facility type that best matches the needs of the design user group can be accommodated within each road segment. Design goals include: continuity of a bicycle facility along the entire length of the corridor, consistency of facility type along the entire length of the corridor, and greater than minimum operating width along the facility where feasible.**

In downtown and village centers facility types may include shared use paths, bicycle lanes, wide curb lanes and paved shoulders for basic adult and child bicyclists (Groups B and C), and wide curb lanes, paved shoulders and shared lanes for bicyclists of higher skill levels (Group A).

In rural areas, facility types may include paved shoulders (and shared lanes on low volume roads) for basic adult and child bicyclists (Groups B and C), and wide curb lanes, paved shoulders and shared lanes for bicyclists of higher skill levels (Group A).

Shared use paths, separated from the highway, may be used to complement on-road bicycle facilities in either downtown or rural areas. Refer to Section 2.6.

In a corridor being retrofitted or a roadway being reconstructed or resurfaced, the existing curb to curb or overall pavement width will dictate whether some type of on-road bike facility can fit. When investigating a corridor that will serve numerous destinations, such as in a downtown, it may be most practical to provide space on the road so that bicyclists can access these destinations. On-road facilities work best when combined with either slower travel speeds or lower traffic volumes. They serve more highly skilled bicyclists the best but also will serve other design bicyclists to make essential connections to destinations.

When the design bicyclist is primarily Group C (child) riders and the destination is oriented primarily towards them (such as a school or recreation field), consideration should be given to selecting a shared use path to complement any on-road facilities. Shared use paths work best when providing direct access to one or two specific destinations that cannot easily be served by the road network or which would place bicyclists on a road with high speed, high volume traffic. Shared use paths should be seen as a complement to a network of on-road facilities and not a replacement.

When considering both on-road facilities and shared use paths, it is important to look at the overall continuity provided for bicyclists (and pedestrians) within a corridor. A shared use path may be used to make a direct connection to a destination that eliminates out of direction travel for bicyclists while on-road facilities provide access from the end of the path to destinations best served by the existing road network. Although the two types of facilities may be used together, it is not good practice to switch between on-road facilities and shared use paths many times within a short distance. This can lead to operational problems such as wrong-way riding where the two facility types transition to each other.

**Step 8. Once a bicycle facility has been chosen, evaluate it.**

After choosing the bicycle facility type, the impacts of the improvement will need to be evaluated. This would include potential impacts to natural and cultural



*A shared use path is not a substitute for adequate on-street facilities. Shared use paths are a complementary, nonmotorized extension to the street network and should not preclude shared use of streets either by law or by design.*

## *Planning for Pedestrians and Bicyclists*

resources, utilities, existing right-of-way, etc. The cost of the improvement will need to be evaluated as well.

### **2.8 Additional Resources**

- *AASHTO, Guide for the Development of Bicycle Facilities, 3rd Edition*, American Association of State Highway and Transportation Officials, Washington, DC; 888-227-4860, [www.aashto.org](http://www.aashto.org), 1999.
- *Bicycle Facility Planning*, Suzan Anderson Pinsof and Terri Musser, Planners Advisory Service, American Planning Association, Chicago, IL; (312) 786-6344, 1995.
- *ITE, Design and Safety of Pedestrian Facilities*, Institute of Transportation Engineers, publication RP-026A, Washington, DC; [www.ite.org](http://www.ite.org), 1998.
- *Manual on Uniform Traffic Control Devices (MUTCD)*, Federal Highway Administration
- *National Bicycle and Walking Study (24 volumes)*, Federal Highway Administration, Washington, DC; [www.bicyclinginfo.org](http://www.bicyclinginfo.org), 1991-95.
- *National Highway Institute, Pedestrian and Bicyclist Safety and Accommodation; Participant Workbook*, Federal Highway Administration, publication number FHWA-HI-96-028, Washington, DC; [www.bicyclinginfo.org](http://www.bicyclinginfo.org), 1996.
- *Natural Resource Guidelines for Recreation Path and Trail Planning. Values and Considerations*, 1995. Vermont Department of Forests, Parks and Recreation. Resource Sheets Y-46, Y-47, Y-48, and Y-49.
- *Oregon Bicycle and Pedestrian Plan*, Oregon Department of Transportation, Salem, OR: [www.odot.state.or.us/techserv/bikewalk](http://www.odot.state.or.us/techserv/bikewalk), 1995.
- *Rails-with-Trails: Best Practices Report (Draft)*, Federal Highway Administration, Washington, DC; 2000.
- *Selecting Roadway Design Treatments to Accommodate Bicycles*, Federal Highway Administration, publication number FHWA-RD-92-073, Washington, DC; 1994.
- *Trails for the Twenty-First Century: Planning, Design and Management Manual for Multi-Use Trails* (2nd Edition), Rails-to-Trails Conservancy, 2001

CHAPTER 3



# Pedestrian Facilities

## *Contents*

3.1 Introduction .....	3-4
3.1.1 Applicable Guidelines and Standards .....	3-4
3.2 Design Considerations .....	3-5
3.2.1 User Characteristics and Requirements .....	3-5
3.2.2 Pedestrian Crashes .....	3-7
3.2.3 Accessibility .....	3-8
3.3 Facility Design .....	3-9
3.3.1 Facility Characteristics .....	3-9
3.3.2 Location .....	3-12
3.3.3 Special Considerations in Rural Areas .....	3-13
3.3.4 Pedestrian Amenities .....	3-14
3.4 Sidewalk Dimensions .....	3-14
3.4.1 Width .....	3-14
3.4.2 Running or Longitudinal Slope .....	3-15
3.4.3 Cross Slope .....	3-15
3.4.4 Horizontal Alignment .....	3-15
3.4.5 Surfaces .....	3-16
3.4.6 Driveways .....	3-17
3.4.7 Access Management .....	3-18
3.4.8 Roadway Edge and Separation .....	3-20
3.4.9 Other ADA Considerations .....	3-24
3.5 Intersections and Crossings .....	3-27
3.5.1 Pedestrian Crossing Speeds .....	3-27
3.5.2 Design Principles .....	3-27
3.5.3 Corner Radius .....	3-27
3.5.4 Curb Ramps .....	3-28
3.5.5 Crosswalks .....	3-34
3.5.6 Medians, Refuge Islands and Slip Lanes .....	3-46
3.5.7 Curb Extensions .....	3-49
3.5.8 Midblock Crossings .....	3-50
3.5.9 Illumination .....	3-52
3.5.10 Signalized Pedestrian Crossings .....	3-53
3.5.11 Grade-Separated Crossings .....	3-53
3.5.12 Construction Zones and Temporary Access .....	3-53
3.6 Additional Resources .....	3-53

## *Figures*

3-1	Human Dimensions, Walking and Sitting .....	3-6
3-2	Spatial Dimensions, Pedestrians with Disabilities .....	3-6
3-3	Fatalities Based on Speed of Vehicle .....	3-7
3-4	Defining Streetside Space .....	3-10
3-5	Sidewalk Widths and Clearances .....	3-14
3-6	Meandering Sidewalks .....	3-16
3-7	Wide Sidewalk at Driveway .....	3-17
3-8	Sidewalk with Buffer Zone at Driveway .....	3-17
3-9	Sidewalk Wrapped Around Driveway .....	3-17
3-10	Sidewalk Dips at Driveway .....	3-18
3-11	Retrofitting Driveway Aprons (Before and After) .....	3-18
3-12	Uncontrolled Access Creates Potential Conflict Points at Driveways.....	3-19
3-13	Raised Median and Single Access Reduces Conflict Points .....	3-19
3-14	Conventional Driveway Slows Turning Vehicles .....	3-20
3-15	Intersection-Style Driveway May Encourage High-Speed Turns.....	3-20
3-16	Green Strip Between Sidewalk and Street .....	3-21
3-17	Ditches or Swales as Separation .....	3-22
3-18	Bicycle Lane as Buffer Between Pedestrians and Motor Vehicles (With and Without Curb) .....	3-23
3-19	ADAAG Clearance Guidelines.....	3-25
3-20	Clear Shy Distance at Shoulder-High Barriers .....	3-26
3-21	Minimum Clear Distance at Parking .....	3-26
3-22	Minimum Vertical Clearance at Signs and Structures .....	3-26
3-23	Crosswalks at Wide and Tight Curb Radii .....	3-27
3-24	Effect of Parking on Curb Radius .....	3-28
3-25	Perpendicular Ramp Let Into Curb .....	3-29
3-26	Diagonal Ramp Located at Apex of Curve .....	3-29
3-27	Parallel Curb Ramp .....	3-30
3-28	Diagonal Variation .....	3-30
3-29	Combination Curb Ramp, Midblock Location.....	3-30
3-30	Combination Curb Ramp, Corner Location .....	3-30
3-31	Paired Curb Ramps .....	3-31
3-32	Diagonal Curb Ramps.....	3-31
3-33	Truncated Domes .....	3-34
3-34	Types of Marked Crosswalk Patterns; Standard, Diagonal, Block and Ladder Pattern .....	3-37
3-35	Colored and Textured Crosswalk Design Treatments .....	3-37
3-36	Block Pattern Crosswalk Recommended for State Highways.....	3-38
3-37	In-Street Pedestrian Crossing Sign, Layout .....	3-39
3-38	In-Street Pedestrian Crossing Sign, Placement .....	3-40
3-39	Traffic Signal Intersection Control .....	3-42
3-40	STOP or YIELD Sign Intersection Control .....	3-42

3-41	Uncontrolled Approach to an Intersection .....	3-43
3-42	Typical Curb Extension Design at a Mid-Block Crossing .....	3-43
3-43	School Crossing Layout .....	3-44
3-44	Mid-Block Crosswalk Layout .....	3-44
3-45	Unmarked Crossing, Case A – Long Distance .....	3-45
3-46	Unmarked Crossing, Case B – Short Distance .....	3-46
3-47	Unmarked Crossing, Case C – Specific Site .....	3-46
3-48	Intersection Median/Refuge.....	3-47
3-49	Right-Turn Lane and Pedestrian Refuge.....	3-49
3-50	Curb Extensions, Before and After .....	3-49
3-51	Midblock Crossing of an Arterial Street .....	3-51

***Tables***

3-1	Common Pedestrian Characteristics by Age Group .....	3-5
3-2	Populations Without Access to an Automobile .....	3-6
3-3	Percentage of Accidents Involving Pedestrians Crossing the Street in Vermont .....	3-8
3-4	Recommended Walkway Locations .....	3-12
3-5	Sidewalk Widths and Land Use Considerations.....	3-15
3-6	Recommended Green Strip Widths .....	3-20
3-7	Recommendations for Installation of Marked Crosswalks and Other Needed Pedestrian Improvements at Uncontrolled Intersections.....	3-41
3-8	Vehicle Stopping Sight Distances (Wet Pavements).....	3-43



Burlington



Middlebury



South Burlington



Virtually everyone is a pedestrian. As a group, they exhibit a wide range of needs.

## 3.1 Introduction

Walking is the oldest and most basic form of transportation. Each of us does it every day as some part of every trip, whether walking to a bus stop or across a parking lot to our car.

This chapter identifies “pedestrians” and their needs, describes the characteristics of pedestrian-friendly environments, covers what is needed to improve pedestrian access, and details how to make our transportation infrastructure more walkable.

Pedestrian facilities include sidewalks and walkways, street corners and intersections, and street and driveway crossings.

### 3.1.1 Applicable Guidelines and Standards

**Plan and design facilities for pedestrians in accordance with this manual to the maximum extent possible rather than simply meeting minimum requirements.** Consider these guidelines as well as current conditions and always exercise professional judgment to keep walking safe and convenient on Vermont roads. Lastly, try to enhance rather than merely accommodate the pedestrian experience.

Design pedestrian facilities in accordance with the standards for signs, signals and pavement markings contained in the *Manual on Uniform Traffic Control Devices (MUTCD)*.

In some situations, the recommended guidance may not be achievable due to geometric, environmental or other constraints. In these circumstances, variances from the recommended guidance may be acceptable; however, a facility should not be built to less than the minimum recommendations without adequate documentation that justifies the variance.

The Vermont Statutes Annotated (VSA) apply to the topics discussed in this chapter as follows:

- 23 VSA, Chapter 13, §1025 requires that the state, towns, utilities, and others shall use the MUTCD as the standard when applying traffic control devices to state and town highways.
- 19 VSA. §10c(g)(2) and §905, 24 VSA §2291, VTrans adopted the following policy for the construction and maintenance of sidewalks in 1979. The effective date of approval is July 6, 2001.

**POLICY STATEMENT:** *It is the policy of the Vermont Agency of Transportation that any sidewalk constructed by the Agency, either as a stand alone project or as part of any other Agency funded or permitted construction project, will meet the appropriate state and federal design criteria for pedestrian accommodation. No sidewalk will be built without having in place before construction an agreement between the Agency and the municipality wherein the sidewalk will be built identifying the municipality responsible for all maintenance, including (but not limited to) winter snow and ice removal when deemed appropriate. All sidewalks built by municipalities, other state agencies, or private entities in a state highway or right-of-way must meet the above criteria and have such an agreement in place before construction.*

- 19 VSA. §905, entitled “construction of sidewalks, bicycle paths and footpaths,” permits a municipality to “construct and maintain suitable footpaths, bicycle

paths or sidewalks, or any combination of these, within the limits of town highways where they do not conflict with travel on the highway.” This section also permits VTrans to grant permission to construct and maintain these facilities on state highways.

- 19 VSA. §905a, Curb cuts and ramps requires, “All newly constructed intersections or curbs in the state used by pedestrians shall be constructed with curb cuts or ramps which enable people with ambulatory handicaps to have access to the sidewalk...All curb cuts or ramps in the state shall be of a uniform design where practical.”
- 19 VSA. §10c(g)(2) permits a municipality to request the agency, unless otherwise required by law, to rehabilitate a bridge that does not already carry a sidewalk without adding a sidewalk, or to build a replacement bridge without building a sidewalk or with a sidewalk on only one side.

The Vermont Statutes Annotated does not define a “pedestrian” or “disability.” For the purpose of this manual, the following definitions shall apply:

*Pedestrian* — A person on foot, walking a bicycle, or using an assistive device, such as a wheelchair, for mobility.

*Disability* — With respect to an individual, a physical or mental impairment that substantially limits one or more of the major life activities of such individual; a record of such an impairment; or being regarded as having such an impairment.

The definition of a “pedestrian” includes any person with a disability. Further, any individual who meets any one of the three tests included within the definition of “disability” is considered to be a person with a disability for purposes of coverage under the American with Disabilities Act.

Other documents to review for pedestrian facility design are listed in Section 3.6, Additional Resources.

## 3.2 Design Considerations

### 3.2.1 User Characteristics and Requirements

#### Pedestrian Characteristics

Virtually everyone is a pedestrian. As a group, they exhibit a wide range of needs. Pedestrians also vary greatly in age, height, physical ability, visual acuity, awareness of their surroundings and reaction time. Therefore, it is important to understand that there is no single “design pedestrian.”

A person’s age, physical ability and cognitive capacity influence how they behave and react when walking (refer to Table 3-1).

People with disabilities are confronted by a wide range of conditions that can affect their mobility. Hearing and sight impairments, for instance, reduce the amount of information physically impaired pedestrians receive about the walking environment around them. Physical impairments can influence travel behavior and force a person to travel in a wheelchair, use a cane or guide dog, or forego independent travel altogether.

Cognitively, children have limited capacity to process the information they receive and may not make appropriate decisions about prudent behavior and risk management on the street.

Older adults have a variety of needs as pedestrians. Research shows that people over 60 walk more, yet in some cases may have impaired mobility.

<b>Table 3-1.</b> Common Pedestrian Characteristics by Age Group	
<b>Age 0 to 4</b>	<ul style="list-style-type: none"> <li>• Learning to walk</li> <li>• Requires constant parental/adult supervision</li> <li>• Developing peripheral vision and depth perception</li> </ul>
<b>Age 5 to 8</b>	<ul style="list-style-type: none"> <li>• Increasingly independent, but still requires supervision</li> <li>• Poor depth perception</li> </ul>
<b>Age 9 to 13</b>	<ul style="list-style-type: none"> <li>• Sense of invulnerability</li> <li>• Poor judgment</li> <li>• Susceptible to “dart out” intersection type crashes</li> </ul>
<b>Age 14 to 18</b>	<ul style="list-style-type: none"> <li>• Improved awareness of traffic environment</li> <li>• Poor judgment</li> </ul>
<b>Age 19 to 40</b>	<ul style="list-style-type: none"> <li>• Active, fully aware of traffic environment</li> </ul>
<b>Age 41 to 65</b>	<ul style="list-style-type: none"> <li>• Reflexes begin to slow</li> </ul>
<b>Age 65+</b>	<ul style="list-style-type: none"> <li>• May cross streets with difficulty</li> <li>• May have poor sight</li> <li>• May have difficulty in hearing vehicles approaching from behind</li> <li>• High fatality rate if involved in a crash</li> </ul>

Source: Adapted from *Guide for the Planning, Design and Operation of Pedestrian Facilities* (Draft), American Association of State Highway and Transportation Officials (AASHTO), 2001.

Both children and older adults are more prone to depend on walking for many trip purposes. If adequate provisions for walking are not available, these individuals may be transportation-dependent; that is, they will be forced to rely on others for their transportation needs (refer to Table 3-2).

**Spatial Needs**

Figure 3-1 illustrates approximate human dimensions when walking and sitting. To accommodate two people walking side-by-side or passing each other while traveling in opposite directions, the average width required is 1.4 m (4 ft 8 in).

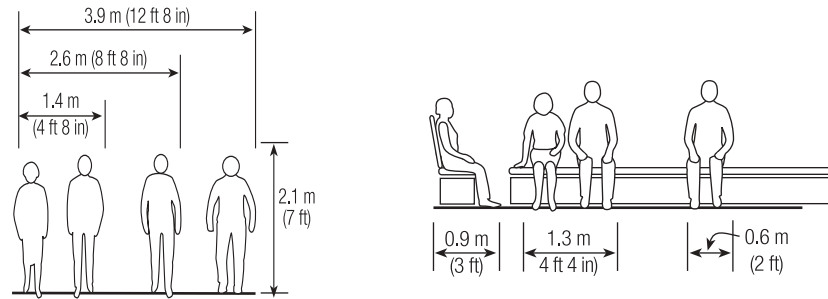

**Figure 3-1.**  
Human Dimensions, Walking and Sitting.

The space required to accommodate pedestrians with disabilities varies considerably depending upon physical ability and the type of assistive device used. By providing adequate space to accommodate a person in a wheelchair most other pedestrians will be provided for. Figure 3-2 illustrates the spatial dimensions of a person in a wheelchair, a person using a walker, and a person using a cane.

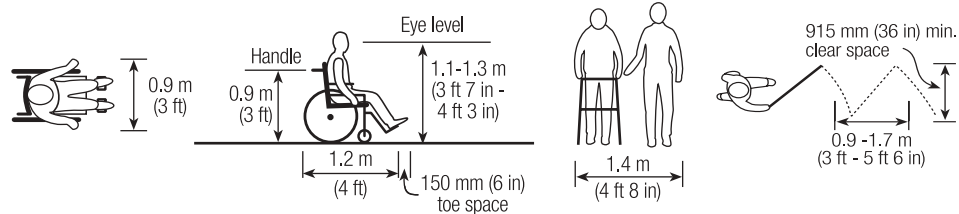

**Figure 3-2.**  
Spatial Dimensions, Pedestrians with Disabilities.

**Walking distance**

A number of factors influence a person's decision whether to walk or drive. One factor is travel time or how long it takes to reach a desired destination.

Directly affecting travel time is the distance to reach a destination or transit stop. Distance is the key factor that limits utilitarian walking trips. The 1995 National Personal Transportation Survey (NPTS) found the average pedestrian trip length to be 0.85 km (0.53 mi).

To reach their destination or a transit stop, pedestrians are likely to walk no farther than:

- One quarter mile (Unterman, 1984)
- 400 meters (1,300 ft) (Atash, 1994)
- Less than one half mile (Noland, 1996)

National surveys also report that one-quarter of all trips by all modes are 1.6 km (1 mi) or less in distance. This suggests that a significant number of trips made via

**Table 3-2.**  
**Populations Without Access to an Automobile**

**Vermont:**

- 2.0-2.5 percent of the state's population  
*Source: VTrans Long Range Transportation Plan Survey, 2000*
- 16,000 households (8 percent of the state's total)  
*Source: Statistical Abstract of the U.S., 1995*

**Chittenden County:**

- 8.5 percent of households  
*Source: Chittenden County Regional Planning Organization, 1997*



**Accommodating people in wheelchairs will also accommodate most other pedestrians.**



other travel modes could be made on foot if conditions were better. Because many Vermonters live in compact villages, many residents and visitors alike would be served by pedestrian facilities within 1 km (0.6 mi) of key destinations such as schools or commercial centers.

**Walking Speed**

People walk at different speeds. The very young and the very old tend to walk more slowly than other pedestrians. An impairment may also slow the walking rate. Even the purpose of the trip plays a role in walking speed. Normal walking rates vary from 0.8 to 1.8 m/s or 2.7 to 6.6 km/h (2.5 to 6.0 fps or 1.7 to 4.1 mph) with an average of 1.2 m/s or 4.4 km/h (4.0 fps or 2.7 mph), according to the *Manual on Uniform Traffic Control Devices (MUTCD)*.

Walking speed is especially critical in places where the pedestrian interacts with vehicular traffic such as intersections and at-grade crossings. The more lanes a person has to cross to reach the other side of the street, the longer the time the pedestrian is exposed to the risk of being hit. Similarly, the slower a person walks, the longer it takes to cross the street.

**3.2.2 Pedestrian Crashes**

Studies have indicated that the faster a motorist is traveling, the higher the risk that injuries to a pedestrian in a crash will result in death. Therefore, as pedestrian facilities are considered, it is appropriate to evaluate, and reduce where necessary, speeds to provide greater safety for pedestrians.

As shown in Figure 3-3, when a person is struck by a motor vehicle, they have an 85 percent chance of being killed when the motor vehicle is traveling at 64.4 km/h (40 mph), a 45 percent chance of being killed at 48.3 km/h (30 mph) and only a 15 percent of being killed at 32.2 km/h (20 mph). Also refer to Section 7.1.2, Benefits of Traffic Calming.

**Characteristics of Traffic-Related Pedestrian Fatalities**

According to *Pedestrian Safety Facts*, National Highway Traffic Safety Administration, (Washington, DC, 1998),

- Most pedestrian fatalities occurred in urban areas (71 percent).
- Nearly one-third (31 percent) of all children between the ages of 5 and 9 years who were killed in traffic crashes were pedestrians.
- More than one-fifth (22 percent) of all traffic fatalities under age 16 were pedestrians.
- Almost half (43 percent) of the 715 pedestrian fatalities under 16 years of age were killed in crashes that occurred between 4:00 p.m. and 8:00 p.m.
- Older pedestrians (ages 70+) accounted for 18 percent of all pedestrian fatalities. The death rate for this group was 3.92 per 100,000 population — higher than for any other age group.

**Common Characteristics of Pedestrian Crashes**

The *Washington State Bicycle Transportation and Pedestrian Walkways Plan; Pedestrian and Bicycle Crash Types of the Early 1990s* (Snyder, Knoblauch, Moore, and Schmitz; Cross and Fisher) found that pedestrian crashes share these common characteristics:

- Driver inattention.
- Struck by vehicle while crossing at an intersection (50 percent of all collisions).
- Struck by vehicle while crossing midblock (33 percent of all collisions).

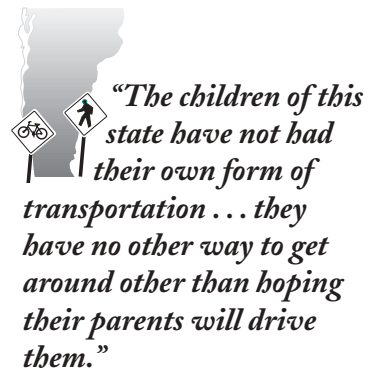

Vermont Long Range  
Transportation Plan, VAOT,  
1995

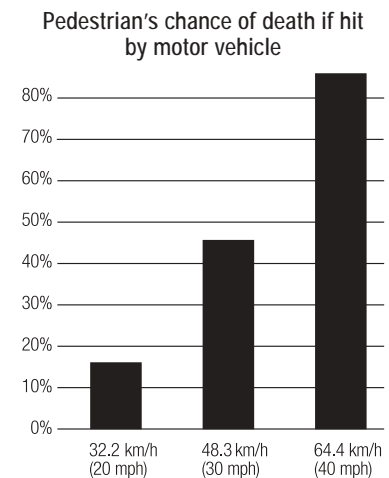

**Figure 3-3.**  
Fatalities Based on Speed of Vehicle  
Source: Killing Speed and Saving Lives, UK DOT.

- Struck from behind while walking along the roadway in the same direction as traffic (particularly in rural areas).
- Motorist exceeding safe speed (contributes to most pedestrian deaths).
- Vehicles backing up (difficult to see children and others walking behind).
- Collisions in urban areas (80 percent of all collisions).

**Table 3-3.**  
Percentage of all Crashes Involving Pedestrians Crossing the Street in Vermont

	1991	1992	1993	1994	1995
In crosswalk at intersection	14%	17%	18%	17%	17%
In crosswalk not at intersection	7%	8%	10%	6%	5%
Jaywalking at intersection	7%	6%	6%	5%	4%
Jaywalking not at intersection	14%	16%	18%	15%	18%
<b>Total</b>	<b>42%</b>	<b>47%</b>	<b>52%</b>	<b>43%</b>	<b>44%</b>

Source: Vermont Agency of Transportation

### 3.2.3 Accessibility

Everyone should have the right of access to services and facilities. The Americans with Disabilities Act (ADA) was enacted to ensure all Americans enjoy such access. The ADA requires pedestrian facilities used by the general public to be planned, designed, constructed, and maintained for use by a wide range of people, including people with disabilities.

Vermont State Design Standards note that:

- All pedestrian paths, sidewalks, stairways, and ramps shall be designed to provide continuous passage, and meet the requirements of the Americans with Disabilities Act Accessibility Guidelines (ADAAG).
- Pedestrian accommodations along the shoulders of roadways do not need to comply with ADAAG grade requirements. However, to the extent that those guidelines can reasonably be achieved, the designer is urged to do so.

To be accessible, safe and convenient public routes of travel need to be provided and barriers and obstacles along such routes need to be removed. Therefore, ADA Title II implementing regulations require that:

- **New construction must be fully accessible**, and follow the ADA Accessible Guidelines (ADAAG) — the legal design standards. The highest degree of accessibility is expected in new construction, when the cost of providing accessible features is nominal compared to the overall cost of construction or subsequent retrofitting.
- **Alterations** shall comply with the same provisions of ADAAG for new construction, unless there are existing physical or site constraints which do not allow for full and strict compliance with minimum requirements. If such constraints exist, the alterations shall provide accessibility to the maximum extent feasible.
- **Existing facilities** — State and local governments must do the best they can to remove barriers to achieve a level of usability that balances user needs, the constraints of existing conditions, and the resources available for remedial work.

Some practical applications of these requirements are:

- New and altered public sidewalks and street crossings must accommodate people with disabilities so they may use the pedestrian routes that connect buildings, facilities, and transportation modes.



The ADA requires pedestrian facilities used by the general public to be planned, designed, constructed and maintained for use by a wide range of people, including people with disabilities.

- Existing facilities and programs must achieve program accessibility goals. Program accessibility, a concept first used in Section 504 of the Rehabilitation Act (1973), means that each service, program, or activity conducted by a public entity, when viewed in its entirety, be readily accessible to and usable by individuals with disabilities, except where to do so would result in a fundamental alteration in the nature of the program or in undue financial and administrative burdens.
- New and altered streets with sidewalks must contain curb ramps. The U.S. Department of Justice defines road resurfacing as an alteration. Alterations trigger the requirement to provide accessible curb ramps at the time of the resurfacing or roadway milling. Merely filling potholes is not considered an alteration (filling potholes, filling cracks, and applying thin coat sealants are considered maintenance).

The ADAAG prepared by the Architectural and Transportation Barriers Compliance Board (also called the Access Board) contains a wide range of administrative and procedural requirements as well as design and construction standards to help ensure compliance with the ADA. ADAAG does not contain all the design issues and specifications that may be encountered in pedestrian environments. Yet, entities are still required to do the best they can to meet the Title II accessibility requirements even if the current ADAAG had not addressed various design specifications. The ADAAG are continually being updated and refined and current versions should be reviewed as part of the design process for every project.

### Accessible Routes of Travel

*Accessible route of travel* — A continuous unobstructed path connecting all accessible elements and spaces in an accessible building or facility that can be negotiated by a person using a wheelchair and that is usable by people with other disabilities.

### Providing Accessible Routes of Travel

It is useful to think in terms of how people, including those with disabilities, need to move *along* (parallel to) and *across* (perpendicular to) travel routes.

Providing access *along* travel routes involves the design and installation of walkways, a class of pedestrian facilities that includes sidewalks, paths and roadway shoulders.

Providing access *across* travel routes involves consideration of appropriate crossing and intersection design.

Together, continuous walkways and safe crossings make up the pedestrian network.

## 3.3 Facility Design

### 3.3.1 Facility Characteristics

#### Design Principles

The following design principles should be incorporated, to the extent that they can reasonably be achieved, into every pedestrian improvement including sidewalks, pathways and crossings. They are ordered roughly in terms of relative importance:

1. **Make it safe.** Design facilities to be free of hazards and to minimize conflicts with external factors such as vehicular traffic and protruding architectural elements.
2. **Make it accessible to all.** Accommodate the needs of people regardless of age

or ability.

3. **Connect to places people want to go.** Provide continuous, direct routes and convenient connections between destinations, including homes, schools, shopping areas, public services, recreational opportunities and transit.
4. **Make it easy and pleasant to use.** Design facilities so that people can easily find a direct route to a destination and so that delays are minimized. Consider the effects of spray or splash from vehicles from the adjacent roadway onto the pedestrian facility.
5. **Provide good places.** Enhance the look and feel of the pedestrian environment. The urban and village pedestrian environment includes open spaces such as plazas, courtyards, and squares, as well as the building facades that give shape to the space of the street. Amenities such as street furniture, banners, art, plantings and special paving, along with historical elements and cultural references promote a sense of place.
6. **Encourage many different uses.** The pedestrian environment is a place for public activities and social exchange. Commercial activities such as dining, vending and advertising may be permitted when they do not interfere with safety and accessibility.
7. **Make it economical.** Design pedestrian improvements for the maximum benefit-to-cost, including initial construction and maintenance costs as well as reduced reliance on more expensive modes of transportation. Improvements in the right-of-way should stimulate, reinforce and connect with adjacent private improvements.

Brunswick, ME



The management of sidewalk conditions helps determine how well sidewalks serve their intended purpose.

Rutland



The Buffer Zone “buffers” pedestrians from the roadway and provides a place for trees, signal poles, signs, street lights, bicycle parking, and snow storage.

### Streetside Space

While simply providing a sidewalk is a major step towards making it easier and safer to walk, the management of sidewalk conditions — including clear space, lighting, landscaping, trees, street furniture, and maintenance — helps determine how well sidewalks serve their intended purpose.

In managing sidewalk conditions in urban and village centers, it can be helpful to look at the space between the edge of the roadway and the right-of-way line. It has three functional zones (see Figure 3-4):

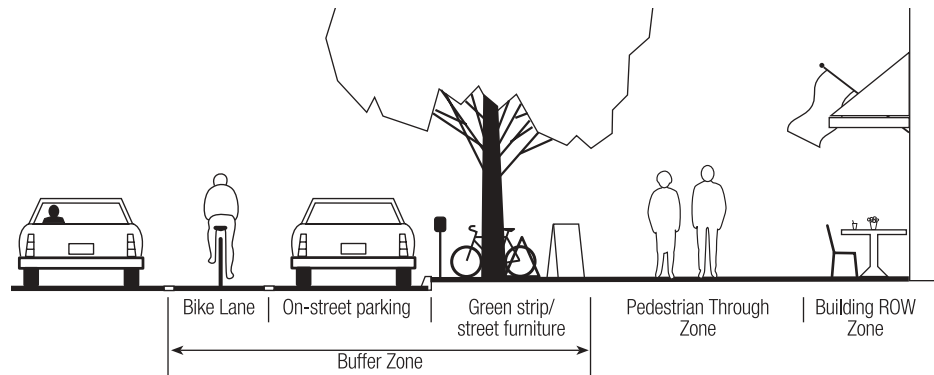

Figure 3-4.

#### Defining Streetside Space

Source: Campaign to Make America Walkable,  
*A Recommended Policy on the Management of Public Sidewalk Space.*

1. **Buffer Zone.** Also known as the “roadside zone” or “fixture/furniture zone.” This area buffers pedestrians from the roadway and provides a place for trees,

signal poles, signs, street lights, bicycle parking, and snow storage. It includes all features between an adjacent travel lane and the pedestrian through zone, including on-street parking, bike lanes and green strips. This is the area where people enter and exit parked cars and may be part of the paved sidewalk or an unpaved green strip.

2. **Pedestrian Through Zone.** Also known as the “pedestrian travel zone.” This is where most people walk. It should be clear of any objects or intrusions, permanent or temporary.
3. **Building/ROW Zone.** Also know as the “building frontage zone.” It is the area between the Pedestrian Through Zone and either the front wall of adjacent buildings or the edge of the right-of-way. In downtowns it is where people window shop, enter and exit buildings, and sit at outdoor cafes.

The pedestrian through zone is the most critical element for pedestrian travel. In downtowns and village centers, adequate buffer and building zones are necessary to maintain a usable pedestrian through zone.

Where on-street parking is present curb extensions may be used to accommodate uses such as transit shelters, utility poles, and signal controller boxes. (Refer to Section 3.5.7.)

The devices and activities listed below frequently compete with pedestrians for sidewalk space.

Surface features (Note that even when the following items are located outside the Pedestrian Through Zone, if they are in the sidewalk it is likely that some people will walk over them.):

- Utility covers.
- Drain covers.
- Ventilation grates.
- Tree grates.

Signs:

- Traffic signs.
- Parking and transit signs.
- Information signs and kiosks.
- Advertising signs.

Parking:

- Parallel parking.
- Angle and perpendicular parking.
- Bicycle parking.
- Delivery vehicles.

Street furniture and fixtures:

- Benches.
- Public art and fountains.
- Transit shelters.
- Fire hydrants.
- Utility poles.
- Signal controller boxes.
- Planters.
- Trash receptacles.

Brunswick, ME



Middlebury



**Pedestrian through zones should be kept clear of any objects or intrusions, permanent or temporary.**

Buffalo, NY



The building/ROW zone, between the Pedestrian Through Zone and the front wall of a building or the edge of a right-of-way, is where people window shop, enter and exit buildings, and sit at outdoor cafes.

- Mail boxes.
- Drinking fountains.
- Parking meters and pay stations.

Other features:

- Snow storage.
- Café/outdoor seating.
- Merchandise displays.
- Street vendors.
- Newspaper and other vending boxes.
- Construction activity (refer to Section 3.5.12).
- Driveway entrances and exits (refer to Section 3.4.6).

### 3.3.2 Location

The fundamental component of increased pedestrian activity is a safe place to walk. Just as vehicles need roads, pedestrians need walkways.

Even if there is no apparent demand for pedestrian facilities, pedestrian travel can be expected to increase where more complete and continuous walkways, crossings, and other pedestrian amenities exist. Indeed, when little or no pedestrian activity is observed along a roadway, professionals should ask themselves, “What factors are responsible for low pedestrian activity?” and “How can I make this place more conducive to walking?” in lieu of assuming that pedestrian demand does not exist or assuming that every trip will be made by motor vehicle.

#### Where Sidewalks are Needed

In commercial centers and downtowns, and along major residential streets, sidewalks are often needed on both sides of streets. This enables pedestrians to access all destinations along a street and minimizes the need for crossings. Also, sidewalks serve as social and recreational facilities in front of any residential property. Finally, sidewalks are a key element in fulfilling accessibility requirements.

A sidewalk on one side of a local street may be adequate in residential areas, especially where no existing sidewalk exists. Available right-of-way, roadside limitations such as cross slope, and pedestrian circulation patterns play a role in deciding whether to place sidewalks on one or both sides, and on which side.

In rural and suburban areas, sidewalks are needed to provide access to schools, local businesses, parks, office buildings, industrial plants, and residential developments. The higher speeds of traffic and general absence of lighting in rural areas reinforce the need for sidewalks. Data indicate that sidewalks in rural areas reduce pedestrian injuries and fatalities.

South Burlington – U.S. Route 7



The fundamental component of increased pedestrian activity is a safe place to walk. Just as vehicles need roads, pedestrians need walkways.

**Table 3-4.**  
Recommended Walkway Locations.

• Commercial centers and downtowns	Both sides of all streets.
• Major residential streets	Preferably on both sides.
• Local residential streets	Preferably on both sides, but at least one side.
• Low-density residential (1-4 units/ac)	Preferably on both sides, but at least one side with appropriate shoulder on other side.
• Rural residential (less than 1 unit/ac)	Preferably on one side with appropriate shoulder on other side, but at least a shoulder on both sides.

Adapted from *Design and Safety of Pedestrian Facilities*, Institute of Transportation Engineers (ITE)

### 3.3.3 Special Considerations in Rural Areas

Many rural areas may not lend themselves to specific pedestrian facilities. These areas are characterized by conditions that include unpaved roads, sparsely settled areas, an absence of street lights or other nighttime illumination, narrow roads and right-of-ways, difficult topographic conditions, limited horizontal and vertical sight distances, open ditches and swales, and great distances between destinations. Although traffic volumes may be low and vehicles infrequent in rural settings, traffic speed and the percentage of heavy vehicles can be high.

Notwithstanding these deterrents, walking does take place, whether for visiting neighbors, getting some exercise or because walking may be the best way to enjoy the out-of-doors.

The question is: “How should pedestrians be served in these rural areas and communities?”

Many people who live in rural areas choose to do so because of their attraction to and appreciation of the rural qualities just described. In these areas and especially along miles of local roads, intensive development of pedestrian facilities may not only be unjustified, it may also be unwanted by local residents.

Nevertheless, some actions can be taken to facilitate walking along low volume roadways. These actions principally involve operational, maintenance and enforcement activities and include:

- Keeping grassy shoulders frequently mowed during the growing season and plowed during winter to facilitate stepping off the roadway when traffic approaches.
- Keeping dust down on unpaved roads.
- Keeping posted speed limits low (56 km/h [35 mph] or less).
- Enforcing speed limits.
- Restriping or reallocating road space by reducing travel lane widths and increasing shoulder widths.
- Using a minimum of pavement markings on local paved roads where AADT is very low (400 vehicles per day or less) to encourage slower, more cautious driving.

People who live in a rural community may feel that conditions are already conducive to walking. Residents of Brookfield have rejected multiple opportunities to pave their “main street” in favor of keeping it and other local roads unpaved. Here, residents and visitors alike seem to enjoy walking without the aid of any pedestrian facilities per se or apparent loss of safety.

#### Shoulders as Walkways

In rural areas, where the installation of sidewalks is not feasible due to cost or right-of-way constraints, or where the remoteness of an area would indicate low pedestrian and vehicular volumes, a paved or densely compacted unpaved shoulder on each side of a roadway may be acceptable as a long-term solution, particularly if the alternative is no pedestrian facilities at all.

Pedestrian accommodations along the shoulders of roadways do not need to comply with ADAAG. However, to the extent that those guidelines can reasonably be achieved, the designer is urged to do so. Refer to the Vermont State Design Standards for guidance on shoulder width.

Shoulders may be paved or unpaved. Continuous edge stripes (fog lines) should distinguish paved shoulders from outside travel lanes. Where unpaved shoulders

Brookfield



People who live in rural communities may feel that conditions are already conducive to walking. Thus, actions to facilitate walking may principally involve operational, maintenance and enforcement activities.

Barnard – Vermont Route 12



In rural areas, a paved or densely compacted shoulder on each side of a roadway can accommodate pedestrians.

Randolph – Main Street



Street furniture and other amenities can enhance the pedestrian environment.

are used, a high visual and tactile contrast is desirable in order to clearly define the pedestrian area and discourage drivers from straying onto the unpaved shoulder.

Shoulders intended for use by pedestrians should not be designated as on-street parking.

### 3.3.4 Pedestrian Amenities

A street devoid of pedestrian amenities and street furniture is inhospitable and uninviting. Such environments actually discourage walking. Refer to Chapter 9 Landscaping and Amenities for a complete discussion of amenities (transit shelters, street furniture, restrooms etc.) that can enhance the pedestrian environment.

## 3.4. Sidewalk Dimensions

*Walkway* – A transportation facility built for use by pedestrians, including people in wheelchairs. Walkways may include sidewalks, paths and paved shoulders.

Sidewalks are separated either vertically or horizontally from the adjacent roadway. For a complete discussion of curbed vs. uncurbed sidewalks see 3.4.8 Roadway Edge and Separation.

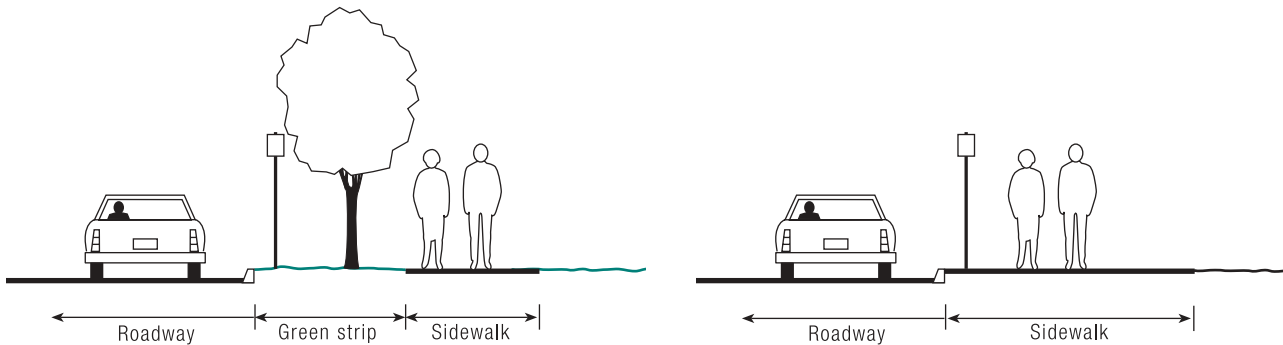

**Figure 3-5.**  
 Sidewalk Widths and Clearances

### 3.4.1 Width

Although many 1.2 m (4 ft) sidewalks were built in the past, this width does not provide adequate clearance or mobility for pedestrians, or people using wheelchairs, to pass in opposite directions.

The minimum width for a sidewalk is 1.5 m (5 ft) and all new sidewalks should be constructed to at least this width.

The recommended sidewalk widths for village and urban centers are shown in Table 3-5 below. All widths represent clear, unobstructed widths. Clear widths may be reduced to as little as 0.9 m (3 ft) at point locations for the shortest practical distances to bypass an obstruction. However, every attempt should be made to locate obstructions (i.e., street lights, utility poles etc.), outside of the minimum clear, unobstructed width of a sidewalk. At driveways, maintain a minimum width of at least 0.9 m (3 ft) with the required 2 percent cross slope. Where a green strip is used (Refer to Section 3.4.8, Roadway Edge and Separation), it may accommodate the driveway apron so that the sidewalk can be kept at the full recommended width.



**Table 3-5.**  
Sidewalk Width & Land Use Considerations

Preferred	Land Use
1.8-2.4 m (6-8 ft)	For <i>local streets</i> outside the central business district
1.8-3 m (6-10 ft)	For <i>commercial areas</i> outside the central business district
2.4-3.0 m (8-10 ft)	For <i>central business areas</i> including downtowns and village centers

Reconstruction of an existing roadway may make it possible to reapportion the right-of-way width between the street, walkway and landscaping elements. Where sidewalk width is inadequate, the adjacent street may have extra width that is available for sidewalk expansion. Some traffic calming treatments such as curb extensions can also provide extra sidewalk width at intersections or mid-block crossings.

### 3.4.2 Running or Longitudinal Slope

Sidewalks generally follow the terrain of the street or road right-of-way. However, the design and construction of walkways should minimize any negative impact terrain might have on accessibility.

Where the grade of the adjacent road is 5 percent or less, limit the maximum running slope of a walkway to 5 percent (1:20) per ADAAG. ADAAG acknowledges that the running slope requirement is impractical when the grade of the adjacent road is greater than 5 percent. ADAAG allows sidewalks to be constructed at the same grade as the road and requires that all other elements of accessibility be provided.

Level landings should be provided where sidewalks slope adjacent to building entrances. Alternatively, a wider sidewalk can provide a transition area between sloping walkways and level landings at building entrances. Use parallel ramps where raised entrances were originally constructed with steps. Stairs may connect walkway levels, as long as a stair-free accessible route of travel is also provided.

### 3.4.3 Cross Slope

Limit the cross slope of a walkway to 2 percent (1:48) per ADAAG. Excessive cross-slope is a major barrier to travel along sidewalks for pedestrians who use wheelchairs, scooters, walkers, and crutches; for pedestrians who have braces or lower-limb prostheses; and those with gait, balance or stamina impairments. Energy that might otherwise be used in forward travel must be expended to resist the perpendicular force of a cross-slope along a travel route.

For curbed sidewalks the cross slope should normally direct surface water toward the street to ensure proper drainage. For uncurbed sidewalks the cross slope should be pitched to carry surface water to a ditch or swale.

### 3.4.4 Horizontal Alignment

In general, sidewalks should parallel the road or street to which they are adjacent. Although meandering walkways may have an aesthetic appeal they also can present problems for pedestrians with sight impairments. If a meandering walkway is desired, minimize the number of curves to avoid creating a route that is unpredictable and indirect. In general, meandering walkways are appropriate to avoid obstacles such as existing trees, natural rock features and utility poles. Consideration should also be given to providing color and texture contrast between the walk-

Rutland



Parallel ramps can facilitate access to buildings where raised entrances were originally constructed with steps.

#### Sidewalk Slope

- Minimum slope consistent with roadway.
- 2 percent maximum cross-slope including driveways.

South Burlington



A meandering walkway may be appropriate to avoid obstacles such as trees. Where used, minimize the number of curves to reduce problems for people with sight impairments.

way surface and the adjacent surface (i.e., concrete vs. grass) to make the edge of the sidewalk detectable to people with a visual disability.

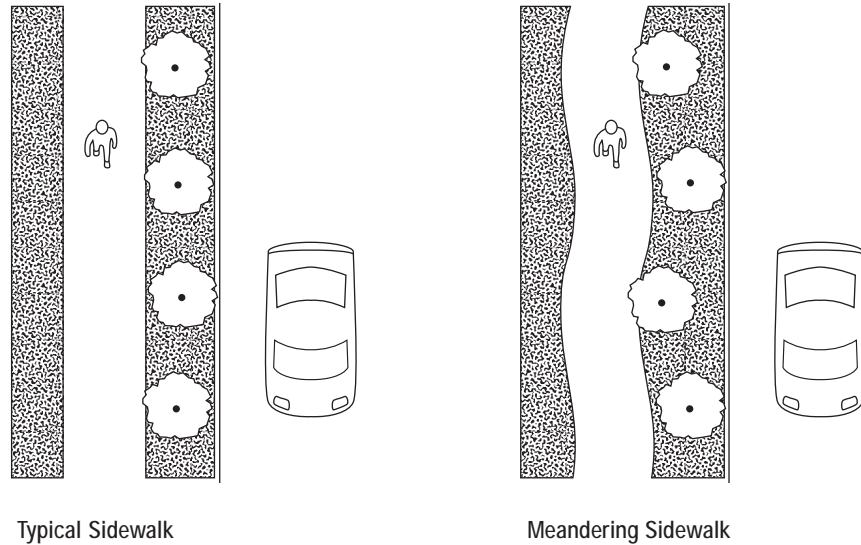

Figure 3-6.  
Meandering Sidewalks

If a meandering sidewalk is desired, minimize the number of curves to avoid creating a route that is unpredictable and indirect.

### 3.4.5 Surfaces

Any material used for walkways must meet the “stable, firm and slip-resistant” criteria of the ADAAG. The two most common surface materials for sidewalks in Vermont are Portland Cement concrete and asphalt. Both are fairly durable materials and, if constructed properly, provide a surface that meets ADAAG. The construction cost of asphalt is slightly lower and many municipalities choose this surface for ease of construction and the ability to surface a greater length of sidewalk for a given amount of funding. In historic settings, concrete sidewalks are considered to be a material that is more compatible than asphalt. The visual contrast that concrete provides, such as at driveway crossings, is a benefit to using that material. These two surfaces have different maintenance needs and methods (refer to Section 10.5.3 - Surface Repairs).

Other materials such as stamped concrete or asphalt, brick, or compacted stone dust may be used as long as ADAAG requirements are met.

In rural areas, alternative surfacing such as compacted crushed stone, compacted earth, or soil cement may be used for walkways. Some runners prefer unpaved surfaces. Such surfaces may also be used to control or limit certain activities such as in-line skating or skate boarding. However, alternative surfacing materials usually have shorter life spans, are more susceptible to breakup by vegetation, and require more frequent maintenance.

Where unit pavers are installed, it may be difficult to achieve positive drainage with the 1:48 (2 percent) cross-slope recommended for sidewalks and shared use paths. For these surfaces, permeable or open joints may be necessary to control ponding. Some specialty pavers are not suitable for sidewalks. Split-face stone units, cobblestones, and similar irregular surfaces are not easily traversed by pedestrians who have mobility impairments and may catch a dragging foot or trigger a painful



Material used for walkways should be “stable, firm and slip resistant.” The two most common surface materials for sidewalks in Vermont are Portland Cement concrete (top) and asphalt (bottom).

spasm in response to repeated jarring in some wheelchair users. Nevertheless, some textured walking surfaces can provide useful cues to pedestrians who are visually impaired when such materials are used as borders and edges of walkways and street crossings. The wide range of surface textures commonly encountered on public sidewalks makes it difficult for pedestrians who are visually impaired to derive a particular meaning from a difference in a commonly used pattern or material.

Exposed aggregate finishes are slippery when wet and are not recommended for sloping surfaces. Incised or imprinted patterns may not be detectable underfoot or to a cane. The truncated dome specification in ADAAG 4.29.2 is highly detectable to blind pedestrians and can be used effectively to indicate the location of a crosswalk or to indicate the division between a walkway and vehicular way, particularly where there is no distinguishable curb. Placement is critical: materials should be installed on the pedestrian walkway or curb ramp immediately adjacent to the street (Refer to Section 3.5.4 Curb Ramps – Detectable Warnings).

As per ADAAG, limit the vertical distances between abutting surfaces of an accessible route of travel to no more than 6.5 mm (0.25 in), or a maximum of 13 mm (0.5 in) if a 1:2 bevel is provided.

### 3.4.6 Driveways

Where sidewalks intersect driveways that are constructed similar to curb ramps (i.e. without curb returns like a street intersection), the sidewalk material should be carried across the driveway. This design detail alerts drivers that pedestrians have the right of way and provides a more continuous pedestrian facility. When a concrete or asphalt surface sidewalk crosses an unpaved driveway, it is preferred to pave the driveway ramp to the street and to pave the driveway back from the sidewalk at least 3.0 m (10 ft). This prevents loose gravel from accumulating on the sidewalk and creating a hazard.

Driveways and driveway aprons that are constructed like ramps, with steep, short side flares, can render a section of sidewalk impassable, especially when encountered in series, as in residential neighborhoods. Compound cross-slopes, such as those that occur at the flares of a driveway apron or curb ramp, may cause tipping and falling if one wheel of a chair loses contact with the ground or the tip of a walker or crutch cannot rest on a level area.

A level area, or area with minimal cross-slope (2 percent or less) is necessary for accessible passage across a driveway. To maintain an acceptable cross-slope and facilitate wheelchair movement at driveways, consider using one of the following techniques to prevent an exaggerated warp and cross-slope:

- Construct wide sidewalks to avoid excessively steep driveway slopes. The overall width must be sufficient to avoid an abrupt driveway slope (Refer to Figure 3-7).
- Incorporate buffer zones so the sidewalk can remain level, with the driveway grade change occurring in the buffer zone (refer to Figure 3-8).
- Where constraints do not allow a buffer strip, wrapping the sidewalk around driveway entrances has a similar effect, although this method may have disadvantages for pedestrians with sight impairments who follow the curb line for guidance (refer to Figure 3-9).
- When constraints allow for only minimal sidewalks behind the curb, dipping the entire sidewalk at approaches keeps the cross-slope at a constant grade. This may be uncomfortable for pedestrians and may create drainage problems behind the sidewalk (refer to Figure 3-10).

#### Walkway Surfaces

- Stable, firm, and slip-resistant.
- 6 mm (0.25 in.) maximum vertical change in level; 13 mm (0.5 in.) if beveled.
- 13 mm (0.5 in.) maximum gratings/gaps in direction of travel.
- 65 mm (2.5 in.) maximum gap at railroad flangeway.

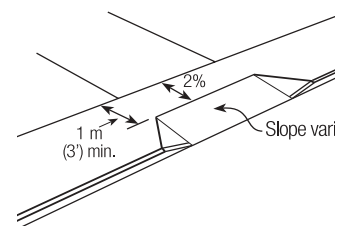

Figure 3-7.  
Wide Sidewalk at Driveway

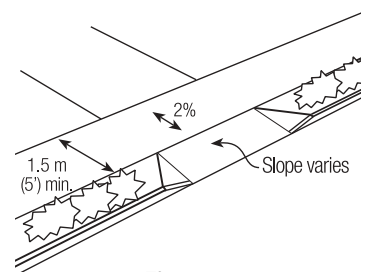

Figure 3-8.  
Sidewalk with Buffer Zone at Driveway

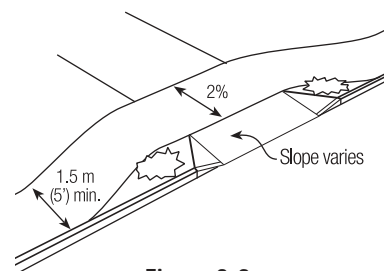
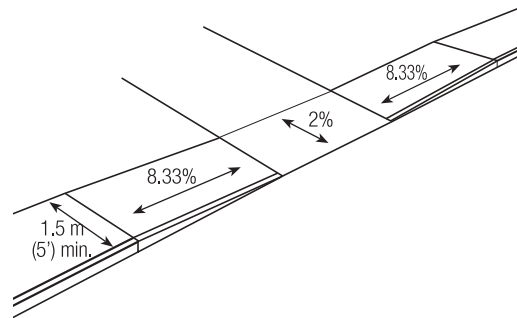
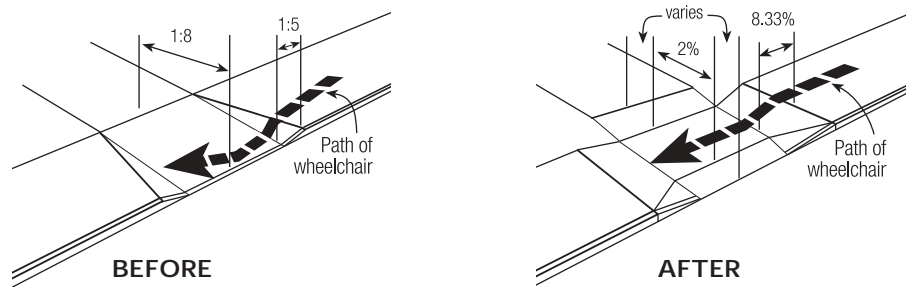

Figure 3-9.  
Sidewalk Wrapped Around Driveway

Excessive cross-slope on driveway aprons can be a significant barrier to sidewalk use. Existing non-complying aprons can be reconstructed to achieve a usable cross-slope for a width of 900 mm (36 in). Cars must slow to negotiate the two steeper ramps on either side of the sidewalk crossing but will not “bottom out” at these angles. Even with narrow sidewalks along the curb, it is possible to retrofit the driveway apron without exceeding the 1:48 (2 percent) cross-slope limitation (refer to Figure 3-11):



**Figure 3-10.**  
 Sidewalk Dips at Driveway



**Figure 3-11.**  
 Retrofitting Driveway Aprons (Before and After)

### 3.4.7 Access Management

For additional guidance on access management refer to the VTrans Access Management Program Guidelines, revised July 17, 2000.

#### Uncontrolled Access

Most pedestrian-motor vehicle collisions on busy streets occur at points of conflicting movements, such as intersections, driveways, and alleys. Uncontrolled vehicle access along roads increases the potential for conflicts between pedestrians walking along a sidewalk and cars entering or leaving the roadway. Pedestrian access to transit stops may also be complicated by excessive driveway access points.

Too many driveways or overly wide driveway openings can confuse drivers, who become uncertain as to when turns into or out of driveways will be made. Also, an excessive number of driveway entrances can promote a large number of turning movements and conflict points with other vehicles, bicyclists and pedestrians, increasing the potential for crashes.

#### Techniques to Manage Access

The primary design techniques used in access management focus on the control and regulation of the spacing and design of:

- Driveways and streets.
- Medians and median openings.
- Traffic signals.

**Benefits of Access Management**

The application of access management can accomplish the following:

- Maintains travel efficiency and related economic prosperity.
- Reduces the number of conflict points (particularly where center medians are used to reduce the number of conflicts between left-turning vehicles and pedestrians).
- Pedestrians' crossing opportunities are enhanced with an accessible raised median and fewer conflicts with turning cars.
- Becomes easier to accommodate people with disabilities with a reduction in need for special treatments at driveway cuts.
- Decreases travel time and congestion when local traffic can find and use other available routes.
- Reserves roadway capacity and the useful life of roads and may reduce the need for road widening, allowing more space within the right-of-way for use by pedestrians, bicyclists, and other enhancements.
- Improves access to properties.
- Provides opportunities to coordinate land use and transportation decisions.

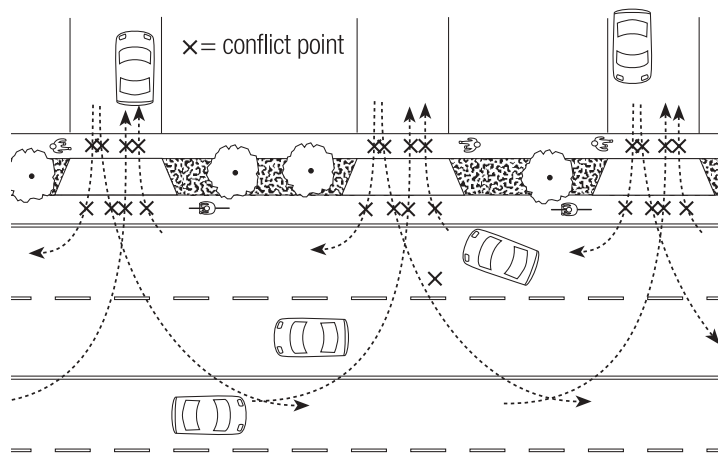

**Figure 3-12.**  
Uncontrolled Access Creates Potential Conflict Points at Driveways

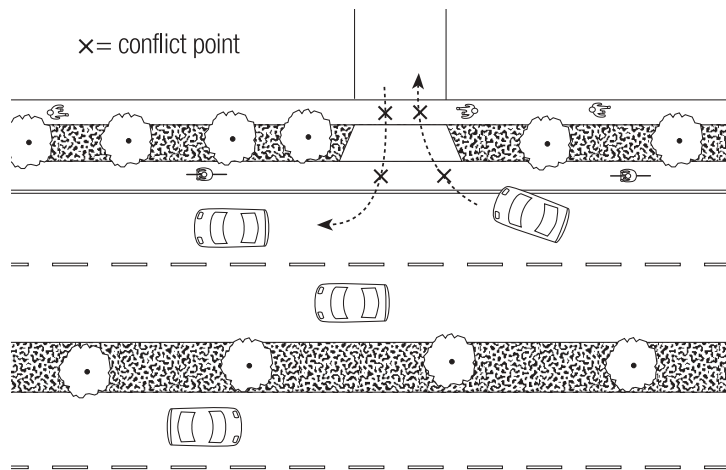

**Figure 3-13.**  
Raised Median and Single Access Reduces Conflict Points

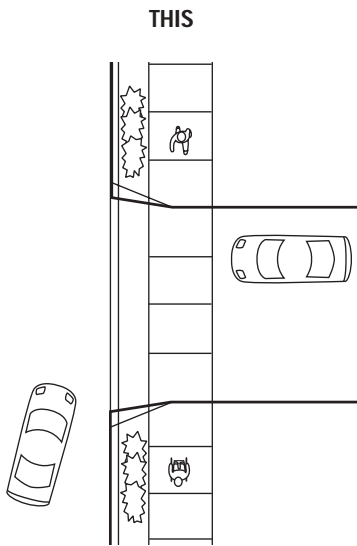

**Figure 3-14.**  
Conventional Driveway Slows Turning Vehicles

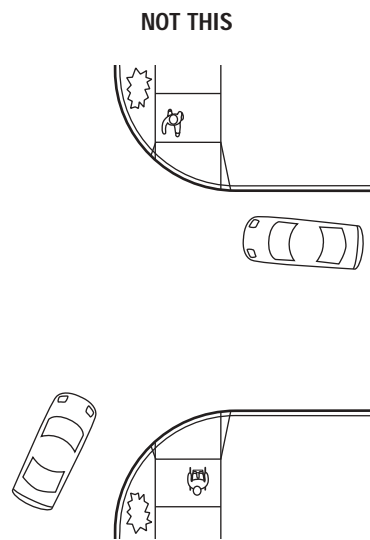

**Figure 3-15.**  
Intersection-Style Driveway May Encourage High-Speed Turns

### Driveways

Access to private property can be built as conventional driveways or with designs that resemble street intersections. For pedestrian safety and comfort, the conventional driveway type is preferred because:

1. motorists must slow down more when turning into the driveway; and
2. the pedestrian right-of-way can be more easily established where the sidewalk is extended across the driveway.

Intersection-type driveways put pedestrians at a disadvantage because:

1. motorists can negotiate the turn at faster speeds, and
2. the right-of-way is not as clearly established, as the roadway appears to wrap around the curb line.

Where an intersection-style driveway is used (such as to implement a “right-in, right-out” policy, employ the following techniques to alleviate problems:

- The street surface material should not carry across the driveway; rather, the sidewalk should carry across the driveway, preferably at a constant elevation, so motorists know they are entering a pedestrian area.
- The radius of the curb should be kept as small as possible.
- Driveway widths should be the minimum needed for entering and exiting vehicles.
- Where the volume of turning vehicles is high, right-turn channelization should be considered, to remove slower turning vehicles from the traffic flow, allowing them to stop for pedestrians; or a traffic signal should be considered where the turning movements are very high.

For additional sidewalk treatments at driveways, refer to Figures 3-7 through 3-11 and the discussion of driveways under Cross Slopes in Section 3.4.3.

### 3.4.8 Roadway Edge and Separation

#### Buffer Zone (Refer to Figure 3-4)

Anything that provides horizontal separation between the outside edge of the travel lane and the nearest edge of the sidewalk is considered a buffer. This may include shoulders, bike lanes, on-street parking and green strips. **The least desirable situation is to place a minimum width sidewalk immediately adjacent to a curb without any buffering feature. This is especially true in higher speed or higher volume corridors.** Buffer zones between sidewalks and roadways improve pedestrian safety and enhance the overall walking experience. Buffer zones provide space for landscaping, street furniture, curb ramps, street lights, utility poles, traffic signs, snow storage and splash protection for pedestrians.

**Table 3-6.**

Preferred width	Recommended Green Strip Widths. Conditions
0.6-1.2 m (2-4 ft)	Local or collector streets.
1.2-1.8 m (4-6 ft)	Arterial or major streets.
1.5-2.4 m (5-8 ft)	Where street trees are proposed, where vehicle speeds or the percentage of heavy vehicles are high.

#### Green Strips

If no other buffering feature (i.e., parking, bike lanes or shoulders) is present a green strip should be provided. If a green strip is the only buffer being provided

adjacent to a sidewalk, it should meet the widths shown in Table 3-6. In most cases, where space is available, wider green strips are desirable.

Green strips are areas of natural vegetation or landscaping that create a buffer from the noise and splash of moving vehicles. As such, green strips help pedestrians feel more comfortable when walking along the street. They can be landscaped in a variety of ways to aesthetically enhance the streetside environment. (Refer to Chapter 9, Landscaping.) Green strips can be raised and bordered by curbing or developed at the same grade level as the roadway, as shown in Figure 3-16.

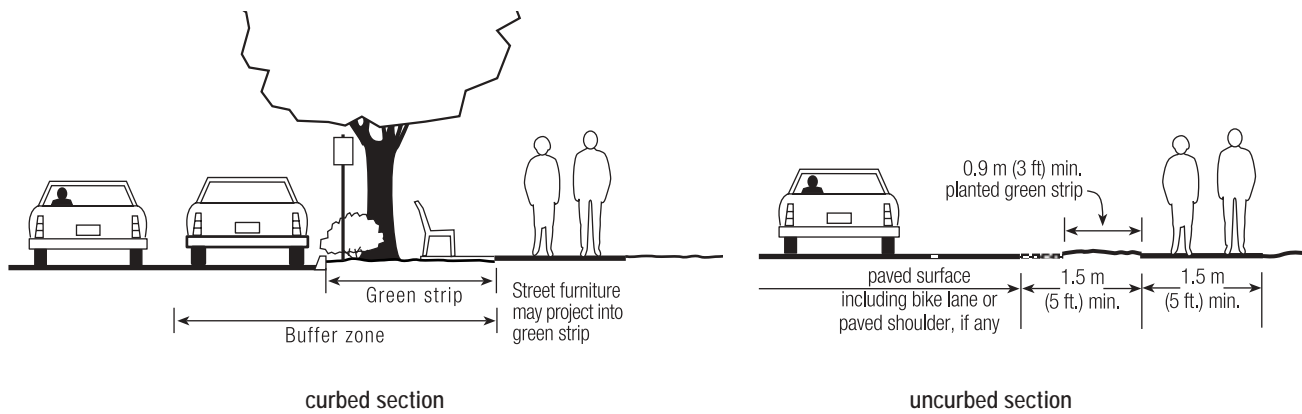

**Figure 3-16.**  
Green Strip Between Sidewalk and Street.

**Advantages of green strips**

- Separation between pedestrians and street traffic.
- Sidewalk can be at a constant elevation across driveways, avoiding grade changes at every driveway cut.
- Essential for accommodating grade changes between roadways, sidewalks and the edge of the right of way.
- Area for drainage runoff and water quality treatment.
- Space to locate street furniture, signs, utility and signal poles, mail boxes, parking meters, fire hydrants and other elements outside the clear space of the walkway.
- Aesthetic enhancement, increasing the appeal of the walkway and improves the pedestrian environment.
- When wide enough, can be planted with larger trees that will provide shade and wind protection; a minimum width of 1.5 m (5 ft) is recommended for tree planting.
- Provides room for the temporary storage of snow.

**Disadvantages of green strips**

- Maintenance is required, and varies depending on the type of materials or landscaping selected.
- If designed and maintained improperly, landscaping may hinder visibility for motorists and pedestrians.
- Root growth can sometimes damage adjacent paved surfaces.

**Ditches or Swales as Separation**

On many rural roadways, an open ditch is located along the edge of the roadway to carry and treat storm water runoff. Where there is sufficient space within the right-of-way, the sidewalk should be located behind the ditch, providing a buffer area between motor vehicle traffic and pedestrians. In situations where a ditch or



Green strips, areas of natural vegetation or landscaping, help to “buffer” pedestrians from the noise and splash of moving vehicles. As such, green strips help pedestrians feel more comfortable when walking along the street.

Middlebury – Main Street



Farmington, PA



Avoid the use of chamfered (top) and rolled (bottom) curbs near pedestrian facilities.

swale exists between a sidewalk and a roadway, provide a minimum of 0.6 m (2 ft) between the edge of the sidewalk and the edge of the ditch or swale. Ditch side slopes should generally not exceed a 1:3 slope. Where vehicle speeds are greater than 65 km/h (40 mph) additional separation is recommended if no physical barrier exists between a sidewalk and shoulder.

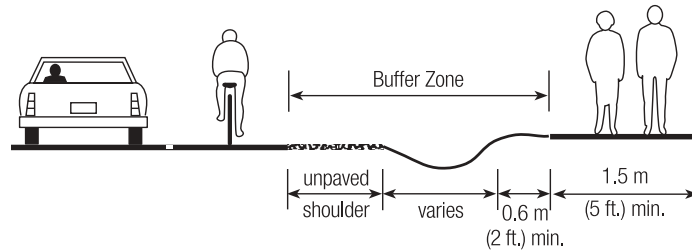

Figure 3-17.  
Ditches or Swales as Separation

### Sidewalk Adjacent to a Vertical Curb

Where sidewalks are located adjacent to a vertical curb and no buffering feature is provided, a minimum of 0.6 m (2 ft) of additional width to the sidewalk for overhanging vehicles and car doors should be provided (refer to Figure 3-21).

A vertical curb provides two primary functions: control of storm water runoff, and a barrier between motor vehicles and pedestrians. Curbs are often required on streets with higher volumes and speeds and where efficiently controlled runoff is a necessity. Vertical curbs are commonly required for urban streets.

Vertical curbs provide a physical barrier adjacent to street parking that helps keep cars from parking on adjacent sidewalks. Curbs also provide a physical barrier between slower moving vehicles and pedestrians. Curbs can be costly to construct, so they may not be practical to build in all areas. Also, curbs have an urban appearance, which may not be desirable in some areas where a more natural roadside appearance is desired.

Vertical curb material types include asphalt, concrete or granite. Granite is the preferred curbing type for Vermont. Although granite can be more expensive than other curbing types it is more durable and the life cycle cost is less than other curbing types.

### Curb Types that are Strongly Discouraged

Avoid the use of the following edge treatments near any pedestrian facility:

- Chamfered (sloped) curbing or mountable curbs that would encourage motor vehicles to drive or park upon a sidewalk.
- Rolled bituminous curbs, also a type of mountable curb design sometimes used in special situations. Although a rolled curb eliminates the need for individual driveway cuts, a rolled curb is easily mountable by motor vehicles and offers little protection to pedestrians.
- Extruded bituminous curbs. Although extruded bituminous curbs provide a relatively low cost vertical barrier between vehicles and pedestrians, they are easily damaged, trap debris, interfere with drainage and maintenance, and are a tripping hazard to pedestrians.

### Uncurbed Sidewalks

When an uncurbed sidewalk is located adjacent to a roadway, it is recommended that there be a minimum 1.5 m (5 ft) separation from the edge of pavement to the



nearest edge of the sidewalk. At least 0.9 m (3 ft) of this area should be a planted green strip (refer to Figure 3-16). This provides a visual separation between the road and the walk helps to discourage parking adjacent to or on the sidewalk and provides an important measure of safety and comfort for pedestrians. Where this separation cannot be provided, a barrier between the roadway and sidewalk may be necessary. See Vehicle Barriers page 3-24.

**Bicycle Lanes as Separation**

When bicycle lanes are located between the vehicle travel lanes and the sidewalk, they provide a buffer between pedestrians and motor vehicles. Where a bicycle lane is located adjacent to a sidewalk in an urban or village center, a vertical curb, a green strip, or a combination of a vertical curb and a green strip is provided between the two facilities. (Refer to Figure 3-18). Refer to Chapter 4, On-Road Bicycle Facilities, for bicycle lane design.

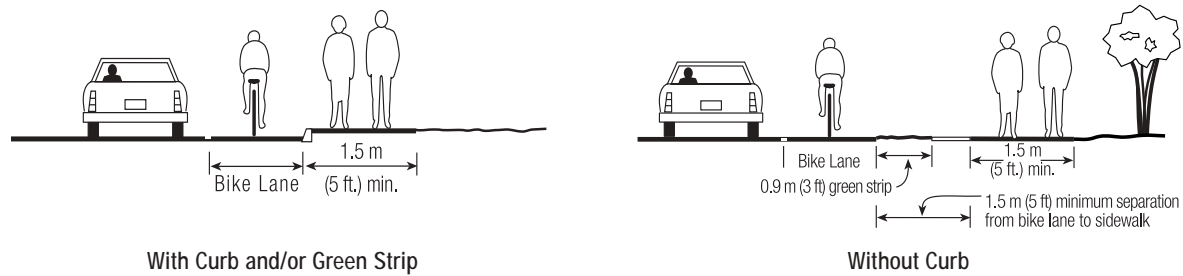

**Figure 3-18.**

Bicycle Lane as Buffer Between Pedestrians and Motor Vehicles

**Hand Rails, Bridge Railings and Vehicle Barriers**

With the exception of sidewalks on bridges, most walkways do not require the use of handrails or vehicle barriers immediately adjacent to the facility. However, there are some cases where a protective handrail is required to protect pedestrians from adjacent hazards. There are also some situations where a vehicle barrier may be needed between a roadway and a walkway.

**Hand Rails**

Where a sidewalk is located in close proximity to a hazard as described below, a protective handrail should be provided along the full extent of the hazard.

Protection is required when:

- A vertical drop along a sidewalk is more than 0.8 m (30 in) in height.
- The drop exceeds a slope grade of greater than 1:4.
- The hazard at the base of the slope is particularly dangerous (i.e., large boulders, rip rap, fast moving water or deep water).

To meet ADAAG guidelines, handrails should meet the following design standards.

The top of the gripping surface of the rail should be a minimum of 865 mm (34 in) and maximum of 965 mm (38 in) above adjacent walkway surfaces. To provide for children, an additional railing can be provided at a maximum height of 685 mm (27 in). From the surface of the sidewalk to the top of the lower rail, all elements of the rail assembly shall be spaced such that a 150 mm (6 in) sphere cannot pass through any opening. For elements between 685 mm (27 in) and the top of the handrail, spacing shall be such that an 200 mm (8 in) sphere cannot pass through

Middlebury – Mill Street



**A handrail attached to a building can help pedestrians more comfortably negotiate sloping sidewalks.**

any opening. Pedestrian railings provided on bridge sidewalks shall meet the standards outlined in the AASHTO Standard Specifications for Highway Bridges, which are also shown in Chapter 5, section 5.3.6, Barriers, Bridge Railings, and Fencing.

### **Vehicle Barriers**

Where sidewalks are located immediately adjacent to a roadway i.e. without any buffer and certain other roadway and traffic conditions exist as described below, designers may consider the use of a barrier between the roadway and the sidewalk.

The factors that should be considered include:

- Traffic volumes — Daily and peak period volumes in correlation with expected high pedestrian volumes.
- Traffic speed — Design or posted speeds in excess of 40 MPH.
- Narrow roadway cross section — Travel lane and shoulder widths at or below minimum values that place vehicles closer to sidewalks.
- Roadway geometry — Sidewalks located on the outside of curves in higher speed corridors.

Vehicle barriers are also sometimes used to protect and direct pedestrians in a construction zone.

The selection of the type of barrier to be used should consider that a very low deflection is desirable to provide adequate protection for pedestrians. The use of barrier between a roadway and sidewalk needs to be based on a thorough engineering analysis that considers all factors including cost. Designers need to be aware that the barrier itself can become a hazard to motorists and therefore must be designed properly. (Refer to AASHTO Roadside Design Guide)

### **Concrete Barriers**

Concrete barriers (also called Jersey barriers) can be used as either permanent or temporary protective separation devices between roadways and pedestrian travel ways, although their primary purpose is to shield and direct vehicles away from potential hazards. However, they may not be the most visually appealing alternative.

Concrete barriers have some of the same potential drawbacks as those listed for extruded and timber curbs. Concrete barriers cost significantly more than curbing, and may not be the most visually appealing solution. When concrete barriers are used for separation between roadways and sidewalks, they need to have a minimum height of 1.1 m (3.5 ft) or have a securely attached horizontal railing at that height. Railings also need to pass the applicable NCHRP crash testing requirements.

Vertical concrete surfaces adjacent to pedestrian facilities should be smooth to avoid snagging of clothing or abrasive injuries from contact with the surface. Bolts or other protrusions from walls, railings, or barriers need to be cut off flush to the surface or recessed.

## **3.4.9 Other ADA Considerations**

### **Gratings**

Surface features that affect accessibility include gratings and similar fittings that have horizontal openings or gaps that exceed 13 mm (0.5 in) in the direction of travel. Such gaps can capture the small front wheel of a wheelchair or the end of a crutch, suddenly stopping forward progress and possibly leading to a fall.

Metal gratings are of particular concern to pedestrians who use walking aids. When wet, the grids can be extremely slippery, and the elongated openings can become a sliding track for the tip of a crutch or cane. Slip-resistant finishes or non-

metallic materials are available at additional cost for installations where the location or extent of exposed gratings may pose a problem for pedestrians, such as on pedestrian bridges and overpasses. Note, however, that tree gratings, unless part of the pedestrian circulation route need not meet surfacing provisions. Where possible, gratings and similar sidewalk fittings should be located outside the pedestrian through zone.

**Gaps**

Flangeway gaps at railroad crossings, particularly where rail lines are integrated into a street or a pedestrian mall, are also an accessibility concern. Where an accessible route of travel must cross a railroad track, accessibility standards require flangeway gaps to be no greater than 63 mm (2.5 in). Even this dimension can trap the small front wheels of a manual chair, or cause the larger wheels of a power chair to swivel and drop sideways into the gap.

To help prevent entrapment, commercial flangeway gap fillers can sometimes be used at crossings where small gaps, light rail or slow moving trains are expected. However, rail lines that carry freight cars may need as much as a 100 mm (4 in) flangeway to avoid train derailments. Currently, there are no flangeway fillers recommended for gap widths, weights and speeds of travel common on freight systems.

**Sidewalk Clearances**

Unobstructed sidewalk clearances are the widths that should be kept clear of all obstructions including landscaping, street furniture, curb ramps, street lamps, utility poles and signs. These and other kinds of obstructions should be placed outside the clear, unobstructed width of a sidewalk or in a buffer zone (Refer to Section 3.4.8, Roadway Edge and Separation) between the sidewalk and the roadway without impairing the visibility of pedestrians and motorists at corners, driveways and crosswalks.

Often, obstacles that encroach upon a pedestrian’s path of travel are beyond the control of the design engineer. However, the following clearance guidelines meet ADAAG (refer to Figure 3-19):

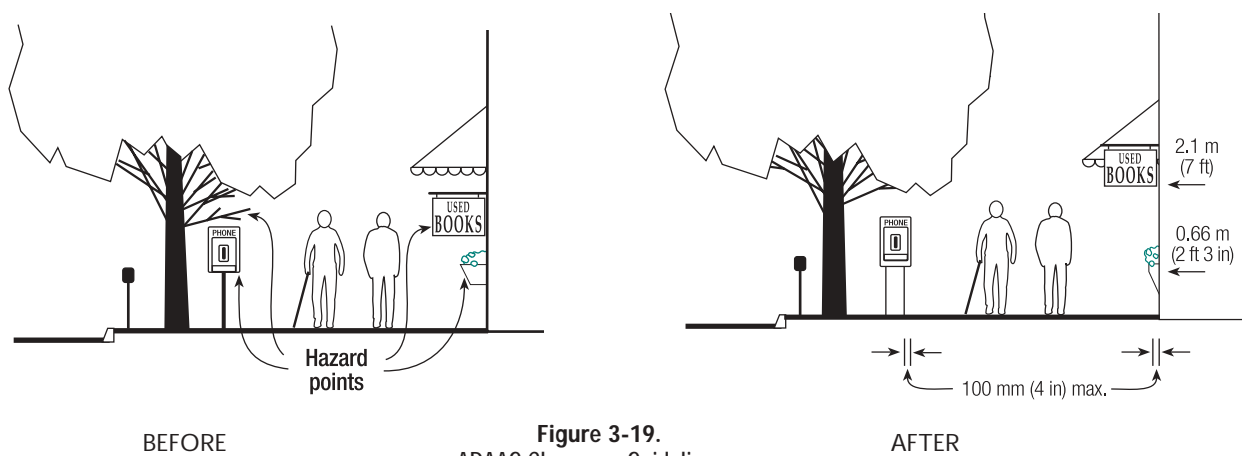
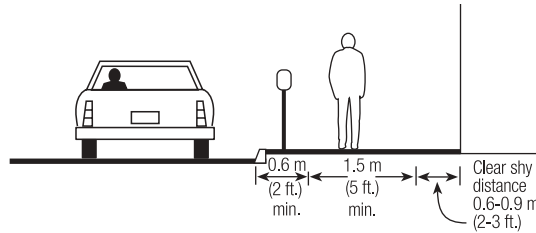

**Figure 3-19.**  
ADAAG Clearance Guidelines

- Objects should not hang lower than 2.1 m (7 ft) over a circulation path.
- Freestanding objects and objects mounted on a wall or post should have no clear open area under the object higher than 675 mm (2 ft 3 in) above the ground.

- Objects higher than 675 mm (2 ft 3 in) and attached to a wall should not protrude from the wall more than 100 mm (4 in).
- Protruding elements should not reduce the clear, unobstructed width of a circulation path to less than 1.5 m (5 ft), or 0.9 m (3 ft) at any point location.

Notwithstanding the minimum ADAAG requirements, the provision of additional clear distance is always preferred where space permits. Provide a clearance of 0.6 to 0.9 m (2 to 3 ft) adjacent to shoulder-high barriers such as building walls, railings and fences (refer to Figure 3-20). On bridges, an additional clearance of 0.6 m (2 ft) from the bridge rail can be attained by increasing the sidewalk width to at least 2.1 m (7 ft).



**Figure 3-20.**  
Clear Distance at Shoulder-High Barriers

Where on-street parking is permitted or likely to be permitted in the future, provide a clearance of 0.6 m (2 ft) between parallel parking stalls and the clear, unobstructed width of the sidewalk or 0.9 m (3 ft) for angled or perpendicular parking to allow for vehicle overhang. Refer to Figure 3-21.

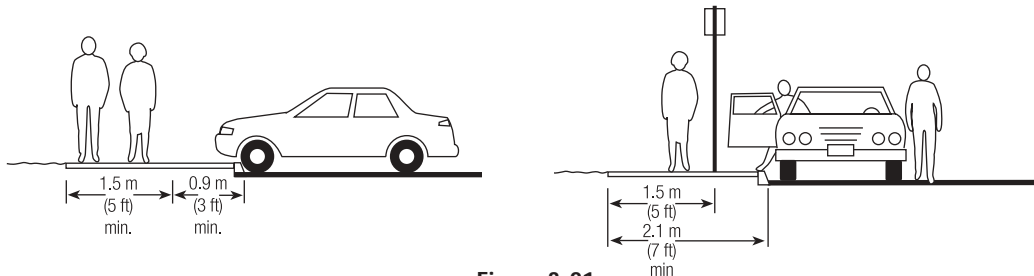

**Figure 3-21.**  
Minimum Clear Distance at Parking

Maintain a vertical clearance of at least 2.4 m (8 ft) between the ground and continuous structures such as undercrossings and permanent canopies. For items such as traffic signs and tree branches located near or within the sidewalk, maintain at least 2.1 m (7 ft) of clearance.

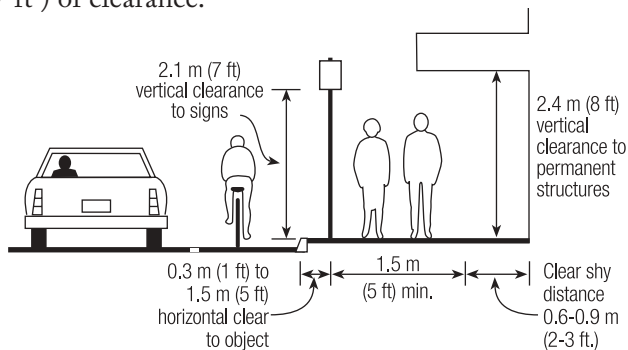

**Figure 3-22.**  
Minimum Vertical Clearance at Signs and Structures



Provide extra clearance between parked cars and the clear, unobstructed width of an adjacent sidewalk to allow for vehicle overhang.

## 3.5 Intersections and Crossings

Access and safety at intersections and crossings is just as important as providing access along a pedestrian corridor. This section provides guidance to ensure access and safety for pedestrians at intersections and crossings.

### 3.5.1 Pedestrian Crossing Speeds

The walking speed normally used for calculating pedestrian crossing times at signalized intersections is 1.2 m/s (4.0 fps), but this may not provide adequate crossing time for all pedestrians. Many studies acknowledge that older pedestrians and people with disabilities are significantly slower and propose that a walking rate of 0.9 m/s (3.0 fps) should be considered. For an in-depth discussion of pedestrian signals, refer to Chapter 8, Signs, Pavement Markings and Signals.

### 3.5.2 Design Principles

Intersections and other crossings that function well for pedestrians:

- Cross no more than 2 lanes at a time without a refuge.
- Slow vehicles down or eliminate free-flowing motor vehicle turning movements.
- Facilitate safe pedestrian movement on all legs of the intersection.
- Allow pedestrians to cross in a direct line across the intersection and clearly identify the direction of travel for all pedestrians, including those with sight impairments.
- Let the pedestrian see and be seen.

### 3.5.3 Curb Radius

In general, a smaller curb radius is better for pedestrians. In comparison to a large curb radius, a smaller curb radius provides more pedestrian area at the corner, allows more flexibility in the placement of curb ramps, allows for shorter street crossings, and requires vehicles to slow more as they turn the corner. Refer to Figure 3-23.

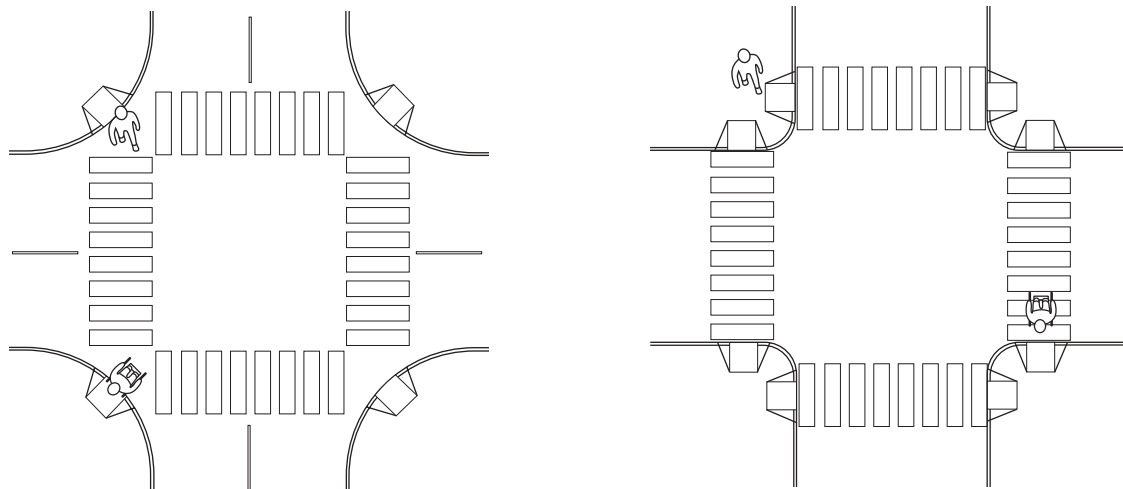

**Figure 3-23.**  
Crosswalks at Wide and Tight Curb Radii.

A wide curb radius requires a longer crossing distance.  
A tight curb radius permits a shorter crossing distance.

The choice of curb radius at a given location is governed by:

- The level of pedestrian activity in a given area.
- The desired size of the pedestrian waiting or platooning area of the corner.

- Traffic turning movements.
- The turning radius of the design vehicle, and the frequency that large vehicles will turn at the intersection.
- The geometry of the intersection (i.e., lane & shoulder widths, intersections angle, etc.).
- The street classification.
- Whether there is parking or a bike lane (or both) between the travel lane and the curb.
- Snow plowing.

The designer must balance all factors, keeping in mind that the chosen radius should be the smallest possible for the circumstances. The radius may be as small as 1.2 m (4 ft) where there are no turning movements, or 1.5 m (5 ft) where there are turning movements and there is adequate street width and a larger effective curb radius created by parking or bike lanes as shown in Figure 3-24.

Curb return radii greater than 9.0 m (30 ft) are not desirable at intersections where there are high numbers of pedestrians crossing, although it may be necessary where large trucks or buses turn frequently. In these situations, consider a pedestrian refuge at large intersections (refer to Section 3.5.6). Also, the pedestrian crossing may be moved back out of the influence of the radius, to minimize the crossing distance.

AASHTO's "Green Book" on highway geometrics provides information regarding the additional pedestrian crossing distance attributable to larger curb radii. The time added to a crossing between curbs increases dramatically at radii above 6.0 m (20 ft). A reduction of 4.5 m (15 ft) in curb radius will usually add enough space to most intersections to accommodate paired perpendicular curb ramps.

If truck and bus turning activity occurs at a minimal level, AASHTO allows a curb radius of 4.5 to 7.5 m (15 to 25 ft) on minor streets. On major streets, AASHTO allows a minimum turning radius of 9.0 m (30 ft) if the occasional truck can turn with minimal encroachment. These standards may vary at the local level. In some cases, local jurisdictions may encourage the use of shorter-than-standard curb radii at intersections where there is likely to be frequent pedestrian crossing activity and large vehicle volumes are low.

### 3.5.4 Curb Ramps

Refer to VTrans Standard Drawings C-3 and C-3M for standard design details.

The sidewalk curb ramp is the design element that allows pedestrians to make the transition in grade from a raised sidewalk to a street or driveway, thereby assuring accessibility in a pedestrian circulation network.

Where new sidewalks or streets are constructed, or existing pedestrian or vehicular ways are altered, curb ramps or other sloped areas must be provided.

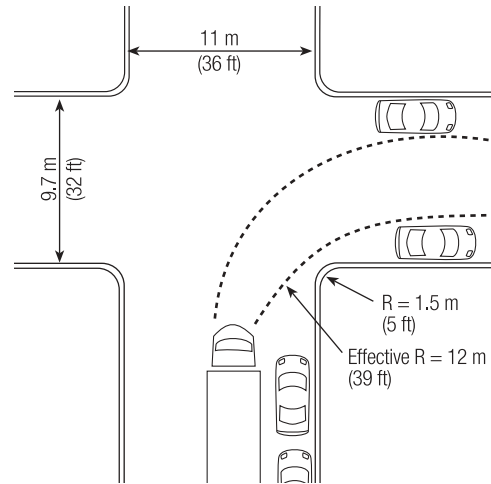

Figure 3-24.  
Effect of Parking on Curb Radius

#### Curb Ramps

- At each crossing.
- Perpendicular to the curb line.
- 1:20 (5 percent) maximum counterslope at gutter. (See text.)
- Level landing at top and bottom.
- Within crosswalk at foot of ramp.
- No exposure to moving traffic lane.
- Flush (no lip) connection at street.
- Effective drainage.

Along existing pedestrian routes that are not otherwise being altered, curb ramps should be installed to provide the benefits of public sidewalks to people who have mobility impairments. Federal regulations require that public entities give priority to providing curb ramps at walkways serving state and local government offices, transportation facilities, places of public accommodation, and employment, followed by walkways serving other areas.

The ADA defines two types of curb ramp systems: “perpendicular” ramps and “parallel” ramps. Combination ramps combine elements of perpendicular and parallel ramps that will result in a better design to fit existing conditions. The selection of curb ramp type is generally a function of available sidewalk width and the ability to provide adequate level landing areas at both the top and bottom of the ramp. VTrans Standard Drawings C-3 and C-3M include dimensional details for both types of curb ramps in a large variety of contexts.

**Perpendicular Curb Ramps**

A perpendicular curb ramp is so named because the run of the ramp cuts the curb it crosses at a 90-degree angle. A perpendicular curb ramp may be located within the radius of a curb line. The elements of a perpendicular curb ramp are the ramp, the flares, the top landing and the bottom landing (as shown in Figures 3-25 and 3-26). To conform with ADAAG, the following guidelines must be followed for ramps:

- 1:12 (8.33 percent) maximum running slope (new construction).
- 1:48 (2 percent) maximum cross-slope on landings.
- 0.9 m (3 ft) minimum width.

At the foot of a curb ramp, a flush connection to a moderate gutter counterslope — no more than 1:20 (5 percent) for a wheelbase distance (approximately 610 mm [2 ft] from the curb — is necessary. This ensures that a wheelchair will not suddenly stop when the front wheels or footrest are caught by an opposing upslope, propelling the pedestrian forward and, perhaps, out of the seat.

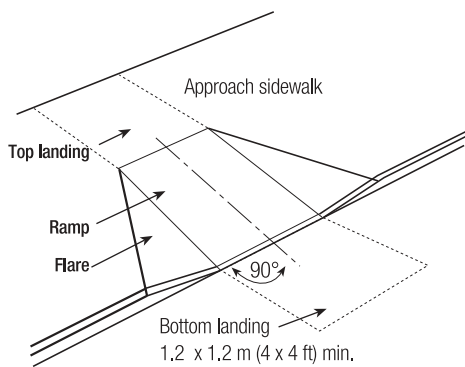

**Figure 3-25.**  
Perpendicular Ramp Let Into Curb

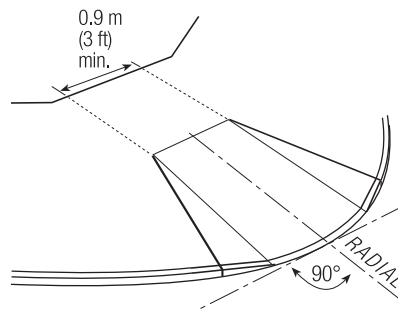

**Figure 3-26.**  
Diagonal Ramp Located at Apex of Curve

Types of Perpendicular Curb Ramps

Where two adjacent curb ramps exist (either to access a set of crosswalks in series or to accommodate adjacent driveways), care must be taken to ensure an accessible route of travel for pedestrians with disabilities. According to VTrans standard drawings C-3, the preferred length of a top area landing between two back-to-back



Perpendicular curb ramp.



Provide a flush connection between a curb ramp and a gutter counterslope to prevent wheelchairs and their occupants from pitching forward into the street.

ramps should not be less than 3 m (10 ft) to avoid a “roller-coaster” effect along a sidewalk. ADAAG requires that the minimum length of any top landing area (including a top landing between two back-to-back ramps) be 1.2 m by 1.2 m (4 ft by 4 ft) to allow a person using a wheelchair of a full level landing area between sloped portions of ramps. If the minimum of 1.2 m (4 ft) cannot be achieved, the sidewalk should remain depressed between the two ramps, thus eliminating the short high spot.

**Parallel Curb Ramps**

Parallel curb ramps slope in the direction of sidewalk travel. Such ramps are most useful where narrow sidewalks are located along a curb. Parallel curb ramps are usually designed using the full approach sidewalk width and therefore do not require flares or curb returns. They consist of two ramps on either side of a level bottom landing that provides adequate space for pedestrians to turn and enter a crosswalk (see Figure 3-27). The bottom landing must be at least 1.5 m (5 ft) long to permit a turn into and out of the crosswalk. Like the sidewalk, landings should not slope more than 1:48 (2 percent) to the street. Like perpendicular ramps, parallel ramps can be located within the radius of a curve as shown in Figure 3-28.



Parallel curb ramp

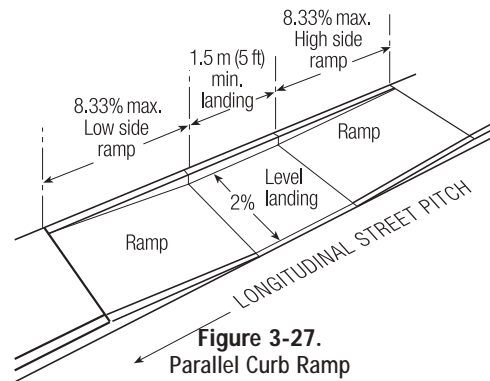

Figure 3-27.  
Parallel Curb Ramp

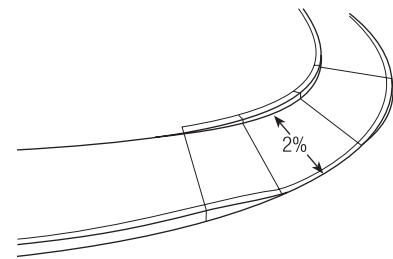

Figure 3-28.  
Diagonal Variation

Types of Parallel Curb Ramps

**Combination (Perpendicular/Parallel) Curb Ramps**

By using parallel and perpendicular ramps together, designers can connect to narrower sidewalks without violating accessibility criteria. The short perpendicular ramp to the street should either be contained within a green strip or include appropriate flares so as not to become a tripping hazard. A level bottom landing must always be provided at the base of the perpendicular ramp.

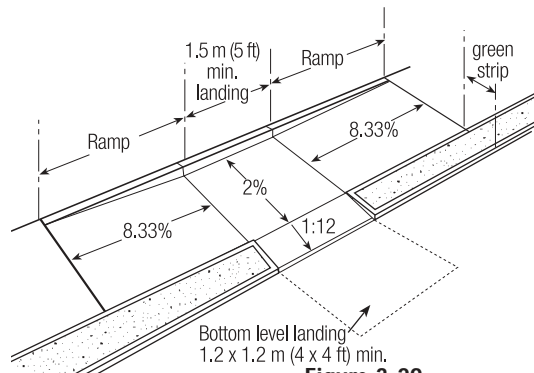

Figure 3-29.  
Combination Curb Ramp, Midblock Location

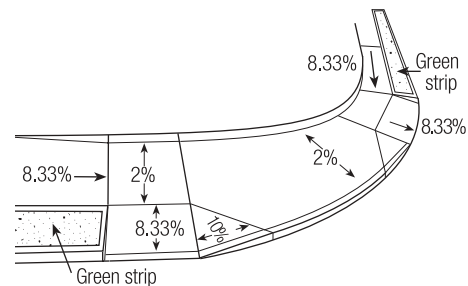

Figure 3-30.  
Combination Curb Ramp, Corner Location



**Ramp Placement**

Good intersection design practice suggests that all pedestrians enter a crosswalk at the same point. The placement of a curb ramp can help direct pedestrians to the preferred crossing location. Curb ramp placement is affected by curb height, crosswalk location, curb radius, and the location of other elements such as utility poles. At corners, curb ramps are either paired (two to a corner) or diagonal (one ramp for both directions).

**Paired curb ramps** are preferred because they lead directly into crosswalks and have the added benefit of providing more useful information to blind pedestrians about the location of the corner and the crossings.

Avoid paired ramps where an angled approach or a turn is required. Pedestrians using wheelchairs must “square off” so they approach a change of slope with both front wheels on the ground at the same time. A skewed approach would leave one caster on the ground, compromising balance and control.

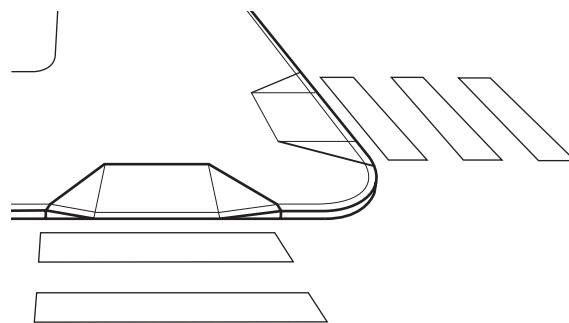

**Figure 3-31.**  
Paired Curb Ramps  
Preferred in most situations.

**Diagonal curb ramps** often require those using wheelchairs to follow a different route than other pedestrians. This is a particular problem with turning vehicles, since a driver may not check for pedestrians entering a crosswalk from unexpected locations.

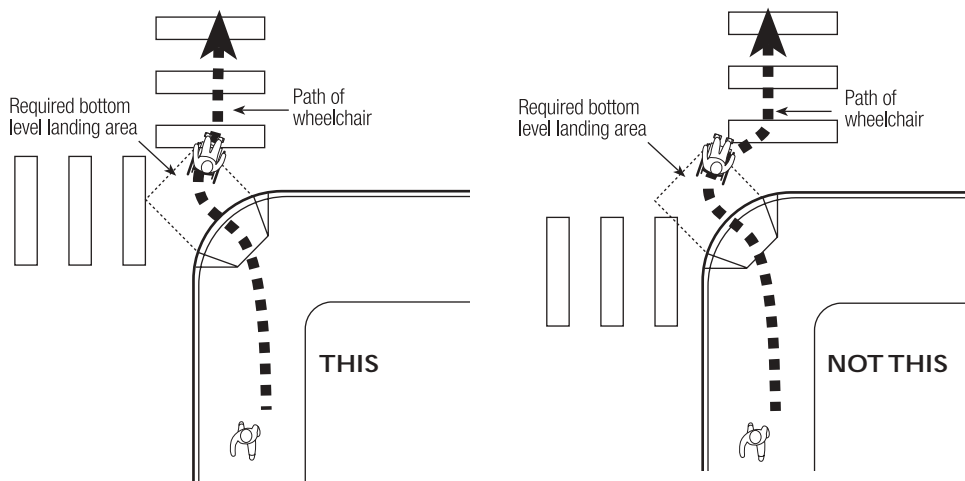

**Figure 3-32.**  
Diagonal Curb Ramps

Diagonal ramps have several disadvantages including poor visibility to drivers, additional maneuvering space, and misalignment with crosswalks.



Diagonal curb ramp

Where it is necessary to use a diagonal curb ramp, the sidewalk requires additional maneuvering space, and the crosswalk must be positioned so the landing at the bottom of the ramp is within the crosswalk area to allow a change of direction toward either of the two perpendicular crossing directions (refer to Figure 3-32). Where curb radii are less than 6 m (20 ft), a diagonal ramp should be avoided, since moving traffic can encroach upon the landing area.

### **Landings**

Level landings at the top of curb ramps make it possible to change direction after leaving the ramp. Top landings also provide a level area that allows pedestrians to bypass curb ramps entirely and people using wheelchairs to avoid traveling across a compound slope of a side flare when using the sidewalk.

In new construction, a top landing length of 1.5 m (5 ft) is preferred. A minimum landing length of 1.2 m (4 ft) — the length of an occupied wheelchair — is required at a perpendicular curb ramp.

Where existing conditions are being altered, a top landing length of 0.9 m (3 ft) may be adequate if toe room is available beyond the sidewalk. Measure top landing length in the direction of travel to and from the ramp.

On parallel ramps, a minimum top landing length of 1.5 m (5 ft) must be provided to avoid trapping the footrest of a wheelchair between opposing up slopes. Landings are considered level when the slope perpendicular to any direction of travel does not exceed 1:48 (2 percent) in any direction.

The bottom landing should fall within the confines of the crosswalk markings. Landings at the top or bottom of ramps must be a minimum of 1.2 (4 ft) in length in the direction of the ramp and not have a cross slope of greater than 2 percent in any direction.

### **Ramp slope**

Accessibility standards set the maximum slope of ramps in new construction at 1:12 (8.33 percent) to provide maximum usability for the widest range of people who have mobility impairments. Curb ramps and ramps to be constructed on existing sites may have slopes as steep as 1:10 (10 percent) for a 15 cm (6 in) rise if it is not technically feasible to provide a 1:12 (8.33 percent) ramp. For a 75 mm (3 in) rise, a 1:8 (12.5 percent) slope may be used where necessary. In historic facilities (such as buildings), a 1:6 (16.67 percent) ramp with a maximum run of 0.6 m (2 ft) is permitted if a lesser slope is not feasible and if the historic significance of the facility would be threatened or destroyed through the use of complying ramps.

### **Ramp Cross-Slope**

Curb ramp cross-slope in new construction should not exceed 1:48 (2 percent). Where street crossings are planned at midblock or T-intersections on sloping roadways, careful engineering is required to blend curb ramp, landing and crosswalk at the edge of the traveled way.

In alterations, a steeper cross-slope may be acceptable if providing a lesser cross-slope is not feasible or excessively costly. However, it should be noted that excessive cross-slopes on curb ramps could make the ramp unusable by most pedestrians with mobility impairments. When a steep cross-slope is encountered, the front casters of a wheelchair tend to direct the chair downhill. This requires the users to expend manual or battery energy to counteract this force. Under slippery conditions, loss of control or overturning can result.

Scooters and power chairs, which are frequently the mode of choice for outdoor travel, are especially susceptible to tipping and overturning due to their high center of gravity. Ambulatory pedestrians who have gait impairments and those who use walking aids can experience difficulty maintaining balance and forward travel on curb ramps with excessive slope.

### Transitions

Transitions from ramps to walks, gutters or streets should be free of abrupt changes and flush without a lip or other difference in level. Maximum slopes of adjoining gutters, road surfaces immediately adjacent to the curb ramp, or accessible route should not exceed 1:20 (5 percent).

The design of curbside alignment and grade needs to address both drainage and accessibility issues effectively. Standard drainage design (gutter slope, lips, gratings, etc.) can conflict with accessibility. In winter, water that rises in the toe of a curb ramp or driveway apron can freeze, making a ramp difficult, unsafe or impossible to use. Gratings near the ramp can trap wheels or walking aids.

### Side Flares

Side flares at curb ramps provide smooth transitions between sidewalks and curb ramps where raised curbs exist. The recommended slope of a side flare is 1:10 (10 percent). Because side flares may exceed the permitted 1:48 (2 percent) cross-slope, an accessible route cannot include travel across a flare. Intended to eliminate tripping hazards for pedestrians, side flares are not intended for people in wheelchairs, and are not required where the edges of the ramp are protected by landscaping or by such appurtenances as signal standards, controller boxes or other barriers to travel across (rather than up or down) a curb ramp.

### Ramp surfaces

Ramps and landings that lead directly to the roadway should have a surface that is finished with a heavy broomed pattern perpendicular to the direction of travel (usually parallel to the curb). The use of grooved concrete or exposed aggregate should not be relied upon to warn pedestrians of potentially hazardous situations, such as ramps.

### Detectable Warnings — Truncated Domes

A detectable warning is a unique and standardized surface intended to function much like a stop sign to alert pedestrians who are blind or visually impaired to the presence of hazards in the line of travel. Currently, raised truncated domes are the only detectable warning allowed by ADAAG. It has been demonstrated that truncated domes are highly detectable by pedestrians with visual impairments so they can determine the end of the sidewalk and the beginning of the traveled way.

Install detectable warnings:

- At the edge of depressed corners.
- At the border of raised crosswalks and raised intersections.
- At the base of curb ramps.
- At the border of medians and islands.
- At the edge of transit platforms and where train tracks cross a sidewalk.

Detectable warning surfaces should extend a minimum of 0.6 m (2 ft) in the direction of travel. The surface should also extend across the full width of the curb ramp or flush surface.

Detectable warning designs using truncated domes should comply with the fol-



Ramps and landings that lead directly to the roadway should have a surface that is finished with a heavy broomed pattern perpendicular to the direction of travel in addition to truncated domes at the base of the ramp.



The use of grooved concrete or exposed aggregate should not be relied upon to warn pedestrians of potentially hazardous situations, such as ramps.

lowing specifications. Truncated domes must have a base diameter of 23 mm (0.9 in) minimum to 36 mm (1.4 in) maximum, a top diameter of 50% minimum to 65% maximum of the base diameter, a height of 5 mm (0.2 in), a center-to-center spacing of 41 mm (1.6 in) minimum to 61 mm (2.4 in) maximum measured along one side of a square arrangement and a base-to-base spacing of 16 mm (0.65 in) minimum. Align domes on a square grid in the predominant direction of travel to permit wheels to roll between the domes. Truncated dome surfaces should not be used for wayfinding or directional information.

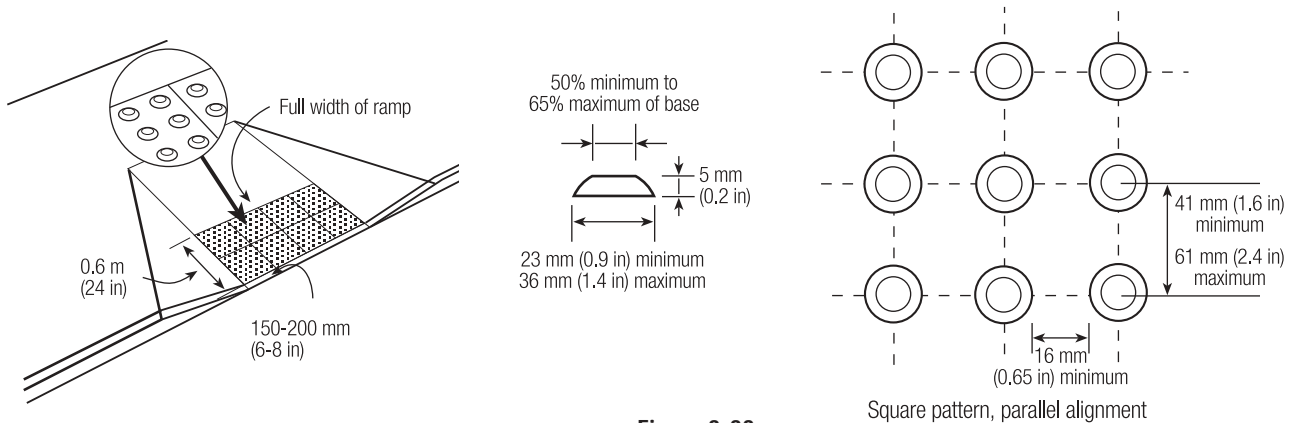

**Figure 3-33.**  
Truncated Domes

For pedestrians with low vision, there should be at least a 70 percent contrast in light reflectance between the detectable warning and an adjoining surface, or the detectable warning can be yellow. The material used to provide visual contrast is an integral part of the detectable warning surface and can be dark-on-light or light-on-dark.

### Alternatives to Curb Ramps

Curb ramps are not the only way to make a street crossing accessible to pedestrians who use wheelchairs. Some municipalities have installed raised crosswalks at intersections, requiring vehicles, rather than pedestrians, to ramp up and down. Raised crossings (also known as speed tables) are typically used for traffic-calming but can also be useful in making narrow sidewalks accessible without the installation of curb ramps. Refer to Chapter 7, Traffic Calming.

Uncurbed transitions between a sidewalk and a street make it difficult for pedestrians with sight impairments to identify the boundary between pedestrian and vehicular areas. Detectable warning surfaces placed at the edge of the walkway adjacent to the street can provide information about the presence of a crosswalk, replacing the cues once provided by raised curbs. Audible locator tones installed as part of a pedestrian signal may also be useful in identifying intersections.

Many older cities and towns have sidewalks raised well above street level, with two or three steps at corners to connect to the street crossing. If there is sufficient walkway width to do so, it is possible to ramp a portion of the sidewalk down to the intersection or a mid-block crossing using design criteria for ramps. Although handrails would not usually be provided at curb ramps, they should be installed on longer ramp runs where the elevation change exceeds typical curb height.

### 3.5.5 Crosswalks

Crossing a street can be the most challenging part of negotiating a pedestrian circulation network. While most people can find a way to safely travel *along* a street, many crashes involving pedestrians take place when they travel *across* a street. There-

Randolph – Main Street



Mid block ramp with handrail.

fore, features that direct pedestrians to appropriate crossing locations, such as marked crosswalks, are essential components of a pedestrian-friendly environment.

Marked crosswalks help send the message to motorists that they are in or approaching a pedestrian area. When combined with curb extensions, illumination and signing, marked crosswalks can improve the visibility of pedestrian crossings.

### Definition

Crosswalks may be either unmarked (see subparagraph a below) or marked (see subparagraph b below). The VSA Title 23, Chapter 001, Section 4, (7) defines a crosswalk as:

- (a) That part of a roadway at an intersection included within the connections of the lateral lines of the sidewalks on opposite sides of the highways measured from the curbs or, in the absence of curbs, from the edges of the traversable roadway, and
- (b) Any portion of a roadway at an intersection or elsewhere distinctly indicated for pedestrian crossing by lines or other markings on the surface.

### Attributes

Properly designed crosswalks include the following attributes:

- *Clarity.* It is obvious where to cross, and markings and signs are clear.
- *Visibility.* The location and illumination of the crosswalk allows pedestrians to see and be seen by approaching traffic while crossing.
- *Sight Distance.* Crosswalks are located in areas that provide adequate stopping sight distance.
- *Appropriate Intervals.* There is a reasonable match between the frequency of good crossing opportunities along a street and the potential demand for crossing.
- *Short wait.* The pedestrian does not have to wait unreasonably long for an opportunity to cross.
- *Adequate crossing time.* At signalized crossings, the time available for crossing accommodates users of all abilities.
- *Limited exposure.* Conflict points with traffic are few and the distance to cross is short or is divided into shorter segments with refuge areas.
- *Continuous path.* The crosswalk is a direct continuation of desired pedestrian travel paths.
- *Clear crossing.* The crosswalk is free of barriers, obstacles and hazards.

### Crosswalk Locations

Marked crosswalks should be located at all open legs of signalized intersections with adjoining sidewalks and at roadway intersections in a downtown central business district. They should also be considered at other locations such as midblock crossings (Refer to Section 3.5.8, Midblock Crossings) and roadway crossings of shared use paths (Refer to Section 5.3.8, Roadway and Railroad Crossings). However, when considering the installation of a marked crosswalk at a location not controlled by traffic signals or STOP signs, an engineering study should be performed to confirm that a crosswalk in that location is justified and will be safe.

Because children constitute a high percentage of the walking public, crosswalks that provide accessible routes to schools are among the first locations that should be considered. Elderly pedestrians and pedestrians with disabilities are highly dependent on transit, so providing crosswalks at or near transit stops as well as near hous-



***While marked crossings increase the visibility of the pedestrian crossing area, define the space for crossing, and draw pedestrians to an appropriate crossing point, there is no legal difference between a marked or unmarked intersection crossing.***

ing for the elderly should also receive high priority. The following list provides guidance where crossing improvements (including crosswalks) should be considered:

- Part of a school walking route.
- Part of a route identified in a nonmotorized transportation or pedestrian circulation plan.
- Where there is a connection to significant retail activity.
- Where there is an important transit connection.
- Where the distance to a better crossing point is more than 90 m (300 ft).
- Where a majority of the people served by the crossing have a more difficult than average time crossing the street.
- Where a safety problem can be addressed by improving the crossing.

Source: KPG, Inc., for the City of Kirkland Transportation Department, *Pedestrian Improvements Demonstration Project* (Kirkland, WA, 1996).

The ITE states that for marked crosswalks to be continually effective, they must be located and designed in accordance with good judgment and accepted engineering practices.

### **FHWA and MUTCD Provisions Relating to Crosswalk Markings**

The Millennium edition of the *Manual on Uniform Traffic Control Devices* provides the following support regarding crosswalk markings:

- Crosswalk markings provide guidance for pedestrians who are crossing roadways by defining and delineating paths on approaches to and within signalized intersections, and on approaches to other intersections where traffic stops.
- Crosswalk markings also serve to alert road users of a pedestrian crossing point across roadways not controlled by traffic signals or STOP signs.
- At non-intersection locations, crosswalk markings legally establish the crosswalk.

The MUTCD also offers the following guidance regarding marked crosswalks:

- Marked crosswalks should not be less than 1.8 m (6 ft) wide.
- Crosswalks should be marked at all intersections where there is substantial conflict between vehicle and pedestrian movements.
- Marked crosswalks should also be provided at other appropriate points of pedestrian concentration, such as at loading islands, midblock pedestrian crossings, or where pedestrians could not otherwise recognize the proper place to cross.
- Crosswalk lines should not be used indiscriminately. An engineering study shall be required before they are installed at locations away from traffic signals or STOP signs.
- Because non-intersection pedestrian crossings are generally unexpected by the road user, warning signs should be installed and adequate visibility should be provided by parking prohibitions.

### **Crosswalk Patterns**

The “standard” crosswalk pattern consists of two transverse lines that extend across the full width of the roadway. As options, the MUTCD permits the area of a crosswalk to be marked with white diagonal lines at a 45-degree angles to the line of a crosswalk (known as a “diagonal” pattern) or with white longitudinal lines parallel to traffic (called the “block” pattern when wide longitudinal lines are used and the

“ladder” pattern when narrow longitudinal lines are used). When diagonal or longitudinal lines are used, the transverse crosswalk lines may be omitted. This type of marking may be used at locations where substantial numbers of pedestrians cross without any other traffic control device, at locations where physical conditions are such that added visibility of the crosswalk is desired, or at places where a pedestrian crosswalk might not be expected.

Where transverse crosswalk lines are used, the MUTCD requires that “they shall consist of solid white lines that mark the crosswalk. They shall not be less than 150 mm (6 in) and not greater than 600 mm (24 in) in width.” If lines are placed on both sides of the crosswalk, they should extend across the full width of the pavement to discourage diagonal walking between crosswalks.

Notwithstanding the diagonal-type crosswalk pattern specified by the Agency’s “Rules to Implement Title 19 VSA., Section 905b” made effective 7/12/1995, it has been found that the zebra-type and ladder-type crosswalk patterns are equally as visible, but surpass the diagonal-type in performance and maintenance because the longitudinal stripes can be placed outside the friction areas of the tires of motor vehicles.

The figure below illustrates the unique design features of four different crosswalk patterns.

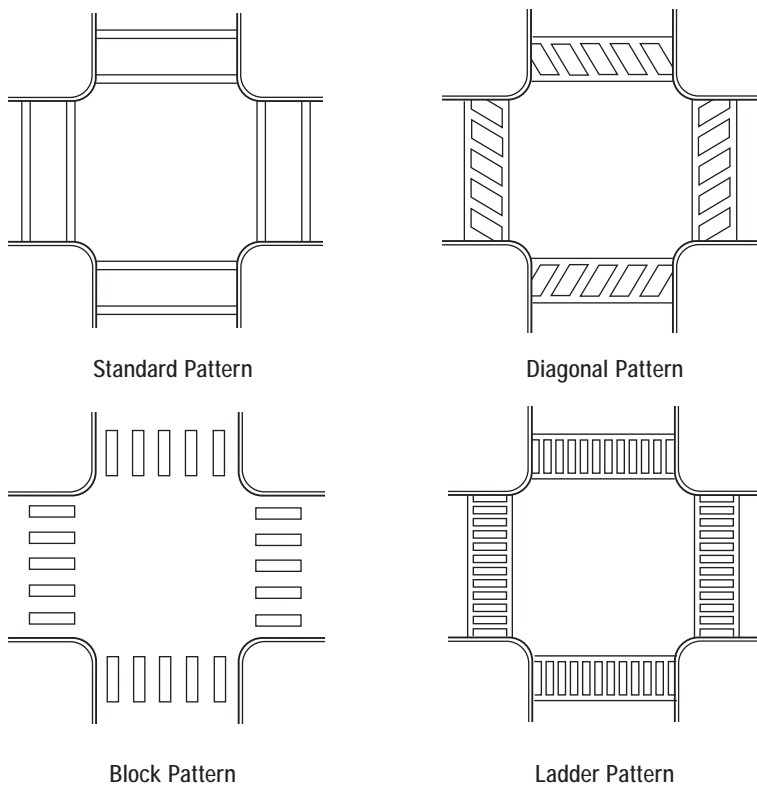

**Figure 3-34.**  
Types of Marked Crosswalk Patterns.



Textured crosswalks provide drivers with visual and audible clues that they are in a pedestrian environment.

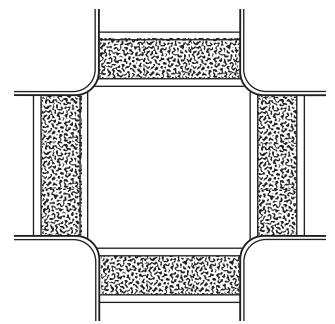

**Figure 3-35.**  
Colored and Textured Crosswalk Design Treatments.

**Colored and Textured Crosswalk Design Treatments**

Colored and textured crosswalk design treatments are often used in village and downtown centers to improve the aesthetics of crosswalks. The most common example of this treatment is a terra-cotta colored, brick pattern that is stamped into newly laid asphalt. Paver systems that may shift and/or settle should not be used. There are other patterns available, including cobblestone and other geometric patterns. The benefits of textured crosswalks are that they provide a visual and audible

cue to drivers that they are in a pedestrian environment and they enhance the streetscape. In accordance with the MUTCD white, yellow, blue or red cannot be used for solid textured crosswalks .

When using this type of treatment, consideration must be given to safe accommodation of people with disabilities. To accommodate these users, care should be taken to ensure that the material used in these crosswalks is firm, stable, slip resistant and visible. Textured pavements are generally preferable over actual decorative material such as bricks or pavers, however they can still present a bumpy surface. The surface texture should be vibration free with a limit of 7 mm (0.25 in) or less of rise not more than every 750 mm (30 in).

The use of colored and textured crosswalks alone without any additional pavement markings does not legally constitute a marked crosswalk. One of the MUTCD approved crosswalk patterns must be used to delineate the colored and/or textured area. However, the preferred marking is the “standard” (two parallel transverse white lines) crosswalk marking as shown in figure 3-35.

**Preferred Design for Marked Crosswalks on State and Local Highways**

The following crosswalk guidelines are recommended for crosswalks in Vermont.

- The preferred width of a crosswalk is 2.4 m (8 ft). A wider crosswalk may be used where high pedestrian volumes exist or where it is desirable to increase the visibility of a crossing. The minimum width of a crosswalk is 1.8 m (6 ft).
- The high visibility block pattern is the preferred marking for marked crosswalks. Like the diagonal pattern (which has been the crosswalk pattern of choice in the past), block pattern crosswalk has been found to be highly visible. However, the block pattern surpasses the diagonal-type in performance and maintenance because stripes can be placed outside the friction areas of the tires of motor vehicles. Refer to Figure 3-36.
- Block pattern crosswalks should be installed using 300 to 600 mm (12 to 24 in) wide stripes spaced 300 to 600 mm (12 to 24 in) apart. The spacing design should avoid wheel paths.
- Marked crosswalks should be placed as close to perpendicular as possible, unless a traffic engineering study determines otherwise.
- Where possible, the intersection edge of a crosswalk pattern should be placed 0.6 m (2 ft) from the outside line of the intersecting roadway.
- Curb ramp locations should be considered when placing crosswalk markings. Pedestrians using wheelchairs must be able to access curb ramps from within the crosswalk pattern area.

Middlebury



The high visibility block pattern is the preferred crosswalk marking. Stripes can be placed outside the friction area of tires improving performance and reducing maintenance of the crosswalk marking.

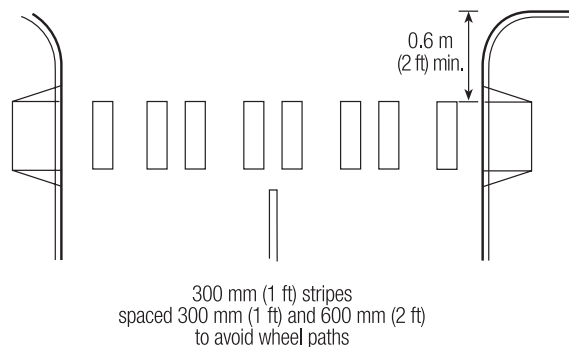

**Figure 3-36.**  
 Block Pattern Crosswalk Recommended for State Highways



**New Crosswalks**

The addition of new crosswalks, or the removal/relocation of existing crosswalks on the state highway system can be approved only by the Traffic Operations Engineer or higher authority within the Agency of Transportation.

Crosswalks should be installed at locations protected by traffic signals or stop signs, and at other locations where justified by an engineering study and adequately protected by warning signs in accordance with the MUTCD. Evaluate crosswalks using an engineering study as detailed in the Agency of Transportation’s latest edition of “Guideline for the Installation of Crosswalk Markings and Pedestrian Signs at Marked and Unmarked Crossings.”

The governing bodies of cities and incorporated villages are responsible for crosswalks within their jurisdictions. The governing bodies of towns (select boards) must approve “parallel” crosswalks that span a town highway or private drive, because the town is expected to maintain them. This applies even to parallel crosswalks that are within the state’s right-of-way.

In general, it is not recommended to install “parallel” crosswalks across the throat of driveways or side roads unless an engineering study indicates a high potential for conflict that will be mitigated by a marked crosswalk.

The addition, removal, or relocation of a crosswalk within a state right-of-way must also be approved by the VTrans Traffic Operations Engineer.

**Passing zones**

VTrans “Pavement Marking Placement Guideline” recommends that passing zones should be closed at least 305 m (1,000 ft) in advance of a crosswalk and no less than 60 m (200 ft) beyond a crosswalk. If a new or relocated crosswalk requires the alteration of an existing passing zone, prepare a Passing Zone Pavement Markings form shown in the guide. By the same token, the removal of a crosswalk could create a new passing zone or extend an existing one.

**Stop lines**

At stop-controlled legs of an intersection, if stop lines are used they should be set back a sufficient distance from the crosswalk to ensure that visibility is provided on all approaches to an intersection for both pedestrians and motorists. Stop lines are appropriate in both rural and downtown areas, wherever it is important to indicate the point behind which vehicles are required to stop for a traffic control device.

When used, stop lines should be placed approximately 3.0 m (10 ft), but no less than 1.2 m (4 ft) in advance of and parallel to the nearest crosswalk line. Greater setbacks can help insure a motorist’s view of pedestrians within the crosswalk is not obscured by vehicles in adjacent lanes.

Increasing the distance between a stop line and a crosswalk to improve driver visibility should also be considered where there are large numbers of trucks, buses and pedestrians at an intersection.

**In-Street Pedestrian Crossing Signs**

Many communities are using supplemental crosswalk identification devices, also called in-street pedestrian crossing signs, to communicate pedestrian right-of-way laws and alert drivers of specific crosswalk locations in congested areas. The designs of devices being used are as varied as the communities using them.

- The signs are intended to remind motorists to comply with existing traffic law pertaining to crosswalks (23 VSA, Chapter 013, Section 1051[b]), which re-



**Figure 3-37.**  
In-Street Pedestrian Crossing Sign, Layout

quires drivers to YIELD (including slowing down or stopping if necessary) to a pedestrian in a crosswalk if traffic control signals are not in operation.

Currently, there is no guidance provided in the MUTCD for use of such signs. However, there is a proposed MUTCD revision that includes guidance for their use. If the proposed revisions to the MUTCD are adopted, use of these signs should adhere to the following guidelines:

- They are not to be used at signalized intersections
- The same legend and colors should be used on both sides of the sign.
- The sign should be retroreflective and use a fluorescent yellow-green background
- The support shall comply with the breakaway requirements of the latest edition of AASHTO's "Specifications for Structural Supports for Highway Signs, Luminaires, and Traffic Signals."
- Sign should be placed in a median refuge island, if one is present.

Additionally, in-street pedestrian crossing signs should:

- Be portable.
- Be placed adjacent to, but not in, a crosswalk.
- Be used in districts or zones where traffic speed is limited to 55 km/h (35 mph) or less.

### Marked Crosswalk and Unmarked Crossing Scenarios

There are several general design guidelines that apply to all marked crosswalks.

1. If a STOP bar is placed in advance of a crosswalk, it must be located a minimum of 1.2 m (4 ft) from the crosswalk, measured as a gap between markings.
2. Parking or other obstructions shall not be placed so as to prevent motorists from seeing pedestrians standing on the shoulder or curb. In accordance with 23 V.S.A. Sect 1104c, parking shall not be permitted within 6 m (20 ft) of a crosswalk. Where a curb extension exists, a 3 m (10 ft) setback from parking to the crosswalk is permitted.
3. Crosswalk markings should be installed as close to perpendicular to traffic as possible, unless a traffic engineering study determines otherwise.
4. Drivers should have a clear line of sight to the crosswalk and associated signs at least equivalent to the minimum stopping sight distances for the posted speed as shown in Table 3-8. The MUTCD should be consulted for guidance on placement of advance warning signs.

Several different pedestrian crossing situations are described below:

#### Marked Crosswalks at Controlled Intersections

All intersections that have signals, STOP signs or YIELD signs to facilitate motor vehicle crossing of streets and arterials, should also be designed to accommodate pedestrians. Where crosswalks are marked at controlled locations, pedestrian crossing signs shall not be installed at the crosswalks. Advance warning signs shall not be placed on the roadway approaches denoting pedestrian activity at the intersection.

**Signalized intersections.** Provide marked crosswalks on all open legs of a signalized intersection.

Sidewalks should guide pedestrians to the point of crossing in the intersection. Marked crosswalks should not be installed in the absence of sidewalks unless adequate shoulders exist.

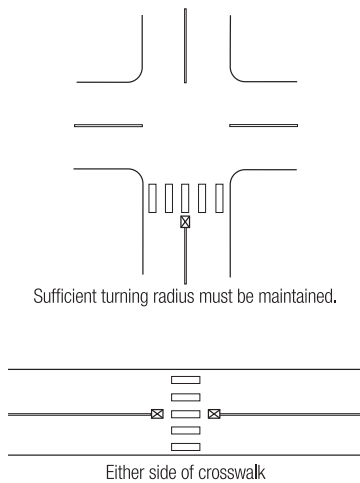

**Figure 3-38.**  
In-Street Pedestrian Crossing Sign,  
Placement



In street pedestrian crossing signs help communicate pedestrian right-of-way laws and alert drivers of specific crosswalk locations.

**Table 3-7**  
Recommendations for Installation of Marked Crosswalks  
and other Needed Pedestrian Improvements at Uncontrolled Locations

Roadway type (number of travel lanes and median types)	Vehicle ADT < 9,000			Vehicle ADT > 9,000-12,000			Vehicle ADT >12,000-15,000			Vehicle ADT > 15,000		
	Speed Limit**											
	≤48 k/h (30 m/h)	56 k/h (35 m/h)	64 k/h (40 m/h)	≤48 k/h (30 m/h)	56 k/h (35 m/h)	64 k/h (40 m/h)	≤48 k/h (30 m/h)	56 k/h (35 m/h)	64 k/h (40 m/h)	≤48 k/h (30 m/h)	56 k/h (35 m/h)	64 k/h (40 m/h)
2 lanes	C	C	P	C	C	P	C	C	N	C	P	N
3 lanes	C	C	P	C	P	P	P	P	N	P	N	N
Multi-lane (4 or more lanes) with raised median***	C	C	P	C	P	N	P	P	N	N	N	N
Multi-lane (4 or more lanes) without raised median	C	P	N	P	P	N	N	N	N	N	N	N

\* These guidelines include intersection and midblock locations with no traffic signals or stop signs on the approach to the crossing. They do not apply to school crossings. A two-way center turn lane is not considered a median. Crosswalks should not be installed at locations that could present an increased safety risk to pedestrians, such as where there is poor sight distance, complex or confusing designs, a substantial volume of heavy trucks, or other dangers, without first providing adequate design features and/or traffic control devices. Adding crosswalks alone **will not** make crossing safer, nor will they necessarily result in more vehicles stopping for pedestrians. Whether or not marked crosswalks are installed, it is important to consider other pedestrian facility enhancements (e.g., raised median, traffic signal, roadway narrowing, enhanced overhead lighting, traffic-calming measures, curb extensions, etc.), as needed, to improve the safety of the crossing. **These are general recommendations; good engineering judgment should be used in individual cases for deciding where to install crosswalks.**

\*\* Where the speed limit exceeds 64 k/m (40 m/h) marked crosswalks alone should not be used at unsignalized locations.

**C = Candidate sites for marked crosswalks.** Marked crosswalks must be installed carefully and selectively. Before installing new marked crosswalks, an engineering study is needed to determine whether the location is suitable for a marked crosswalk; For an engineering study, a site review may be sufficient at some locations, while a more in-depth study of pedestrian volume, vehicle speed, sight distance, vehicle mix, etc. may be needed at other sites. It is recommended that a minimum of 20 pedestrian crossings per peak hour (or 15 or more elderly and/or child pedestrians) exist at a location before placing a high priority on the installation of a marked crosswalk alone.

**P = Possible increase in pedestrian crash risk may occur if crosswalks are added without other pedestrian facility enhancements.** These locations should be closely monitored and enhanced with other pedestrian crossing improvements, if necessary, before adding a marked crosswalk.

**N = Marked crosswalks alone are insufficient, since pedestrian crash risk may be increased due to providing marked crosswalks alone. Consider using other treatments, such as traffic calming treatments, traffic signals with pedestrian signals where warranted, or other substantial crossing improvement to improve crossing safety for pedestrians.**

\*\*\* The raised median or crossing island must be at least 1.2 m (4 ft) wide and 1.8 m (6 ft) long to adequately serve as a refuge area for pedestrians in accordance with MUTCD and American Association of State Highway and Transportation Officials (AASHTO) guidelines.

Source: Safety Effects of Marked vs. Unmarked Crosswalks at Uncontrolled Locations; Executive Summary and Recommended Guidelines. FHWA-RD-01-075. April 2001

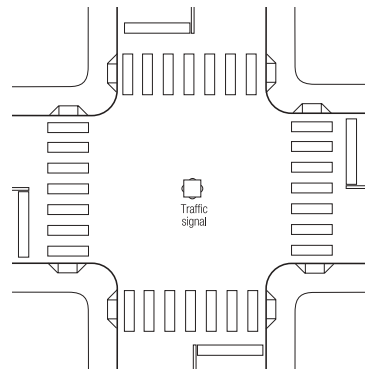
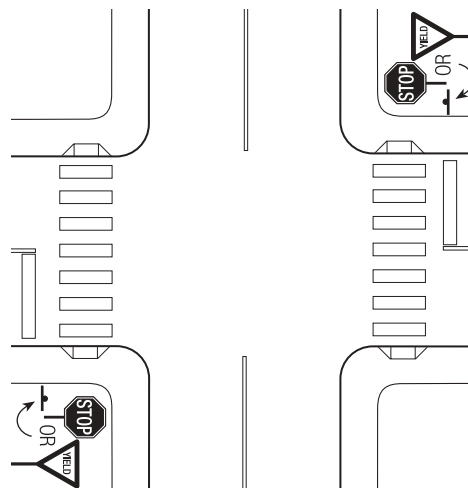

**Figure 3-39.**  
 Traffic Signal Intersection Control.

Traffic signals that are *not* timed to accommodate concurrent pedestrian movements, or those having traffic signal heads that cannot be seen by pedestrians should be examined to determine if modifications are needed to accommodate pedestrians.

***STOP and YIELD sign intersection control.***

A marked crosswalk across a roadway approach controlled by a STOP or a YIELD sign may be provided if there is a sidewalk and/or a shoulder on both sides of the approach.



**Figure 3-40.**  
 STOP or YIELD Sign Intersection Control.

***Uncontrolled Crossings***

Uncontrolled crossings may be located either at intersections or mid-block. Pedestrians need safe access at many uncontrolled locations, including many locations where motor vehicle access is not significant. For general guidance on appropriate crossing treatments for uncontrolled crossings, see Table 3-7.

Marked crosswalks may be placed at intersections on roadway approaches not regulated by traffic signals, STOP signs or YIELD signs if:

- The speed limit is 60 km/h (40 mph) or less, and
- There are sidewalks and/or shoulders on both sides of the approach and where justified by an engineering study.

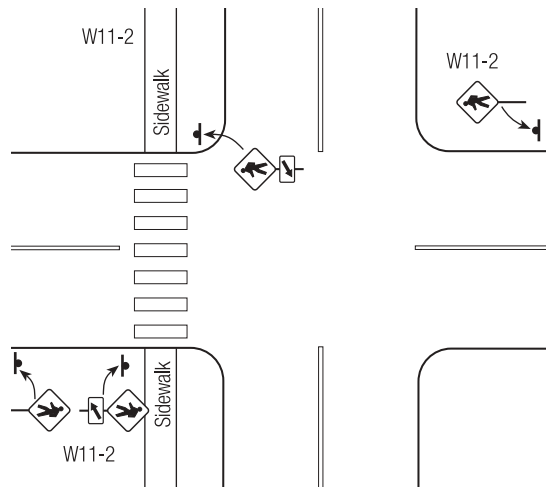

**Figure 3-41.**  
Uncontrolled Approach to an Intersection

Where a marked crosswalk is provided at an uncontrolled mid-block location and on-street parking is present on one or both sides, the use of curb extensions helps to shorten the crossing distance and provide better visibility for both motorists and pedestrians. Refer to Figure 3-42.

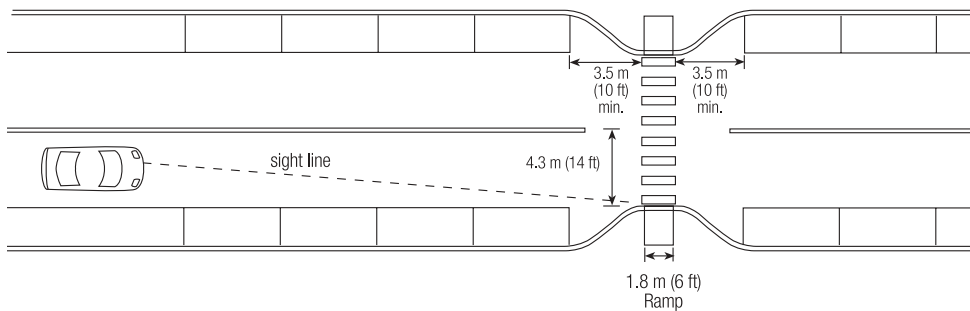

**Figure 3-42.**  
Typical Curb Extension Design at a Mid-Block Crossing

At uncontrolled crossings install a pedestrian crossing sign assembly (W11-2 with diagonal arrow W16-7) at the crosswalk location and an advance pedestrian crossing sign (W11-2) on a roadway approach where unexpected entry into the roadway by pedestrians may occur. Advance warning signs (W11-2) may not be required in a village or downtown area where pedestrian activity is an expected feature of the driving environment.

Marked crosswalks or regulatory signs should be visible to drivers at a distance greater than the safe stopping sight distance for the speed limit as shown in the Table 3-12.

**Table 3-8.**  
Vehicle Stopping Sight Distances (Wet Pavements)

Design Speed (km/h)	Design Speed (mph)	Assumed Speed for Condition (mph)	Stopping Sight Distance (m)	Stopping Sight Distance (ft)
30	20	20	40	125
40	25	24-25	45	150
50	30	28-30	60	200
55	35	32-35	70-75	225-250
65	40	36-40	85-100	275-325
70	45	40-45	100-122	325-400

**Mid-block school crossings.** Install marked crosswalks at all roadway crossing locations along established routes to schools. The difference between a school crossing and a regular mid-block crossing is the use of the school crosswalk signs (S1-1 with W16-7) and the use of the fluorescent yellow-green background for the advance warning, crosswalk signs and supplemental plaques.

Install a school crosswalk warning assembly (S1-1 with diagonal arrow W16-7) at the crosswalk location and an advance school crosswalk warning assembly (S1-1 with supplemental plaque W16-9p or W16-2 or W16-2a) on the roadway approaches as shown in the figure. The school crosswalk signs should only be used at crosswalks adjacent to schools or on school walking routes.

An advance school crosswalk warning assembly may not be required in a village or downtown area where pedestrian activity is an expected feature of the driving environment.



Use school crosswalk signs only at crosswalks adjacent to schools or on school walking routes.

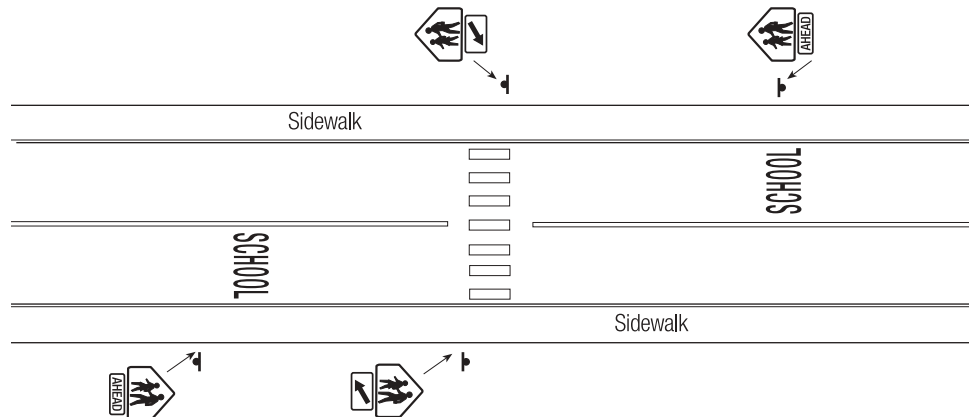

Figure 3-43.  
School Crossing Layout

**Mid-block (non-intersection) crosswalks.** Consider marked crosswalks where concentrated pedestrian activity exists.

Crosswalk markings may be installed at midblock locations across a roadway if the following criteria are met:

- In a village or urban setting.
- Where the speed limit is 60 km/h (40 mph) or less.
- Where no other crossing exists within a distance of 45-60 m (150 to 200 ft) in either direction.

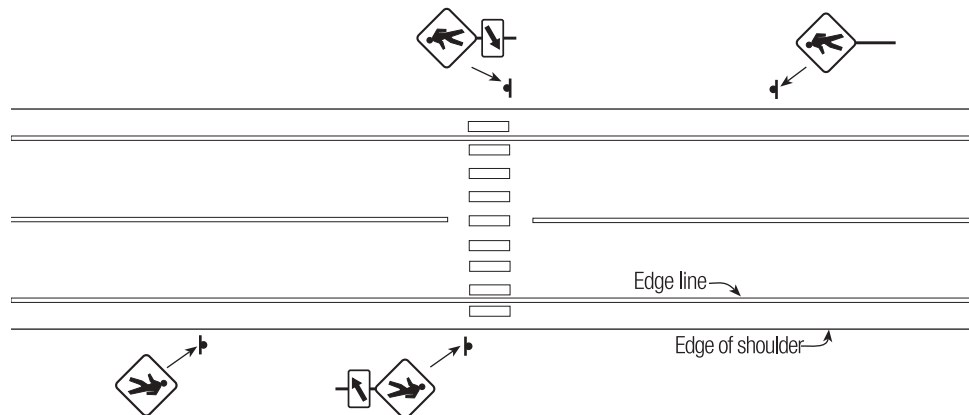

Figure 3-44.  
Mid-Block Crosswalk Layout

Install a pedestrian crossing sign assembly (W11-2 with diagonal arrow W16-7) at the crosswalk location and an advance pedestrian crossing sign assembly (W11-2 with supplemental plaque W16-9p or W16-2 or W16-2a) on a roadway approach where unexpected entry into the roadway by non-motorists may occur. Advance warning signs (W11-2) or an advance warning sign assembly may not be required in a village or downtown area where pedestrian activity is an expected feature of the driving environment.

**Unmarked Crossings**

When the criteria for marked pedestrian crossings are not met, warning signs may be installed as specified in the MUTCD (Chapter 2C, *Warning Signs*).

If signs are determined to be warranted based on available sight distance, the following sign layout details should be used where applicable.

**Case A — Long Distance.** The pedestrian crossing activity occurs randomly over a long distance at various points. A warning sign (W11-2) and a supplemental plaque (supplemental plaque W16-9p or W16-2 or W16-2a) should be used to denote the distance between the signs (which blanket the crossing area). The plaques should not indicate a distance greater than 1.6 km (1.0 mi).

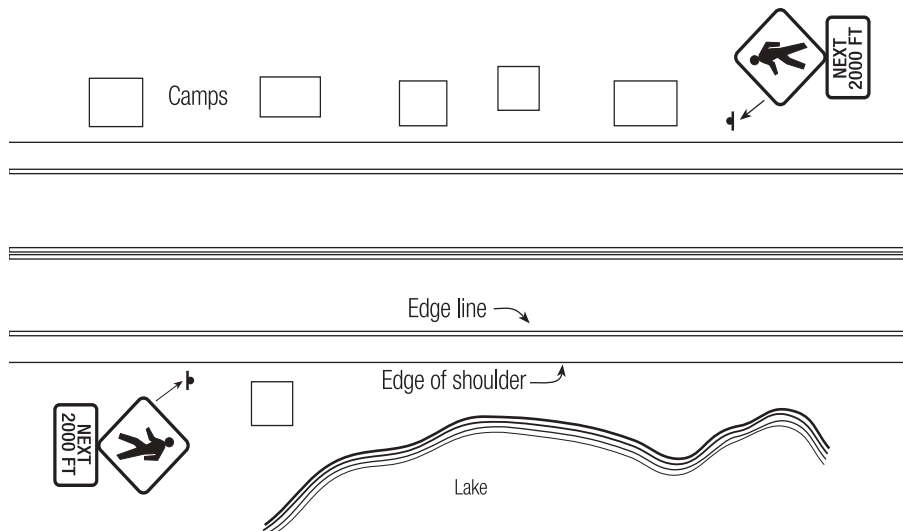

**Figure 3-45.**  
Unmarked Crossing, Case A – Long Distance.

There does not need to be a specific pedestrian volume — merely crossing activity.

An example of this situation is on highways adjacent to lakes and ponds where summer camps and the associated activities take place, or where connections for a hiking trail require foot travel along the roadway.

**Case B — Short Distance.** The area of concentrated pedestrian activity occurs over a length of 150 m (500 ft) or less and is within the view of motorists. These crossings take place only at the location identified and at various times.

Supplemental plaques (W16-9p or W16-2 or W16-2a) should be used to denote the distance between the crossing signs (W11-2). The advance pedestrian signs (W11-2) should be used with the crossing signs.

Case B situations tend to be seasonal locations or locations of activity during certain days. An example is depicted in the figure, where an attraction such as fishing or swimming is on one side of the highway and parking is on the other.

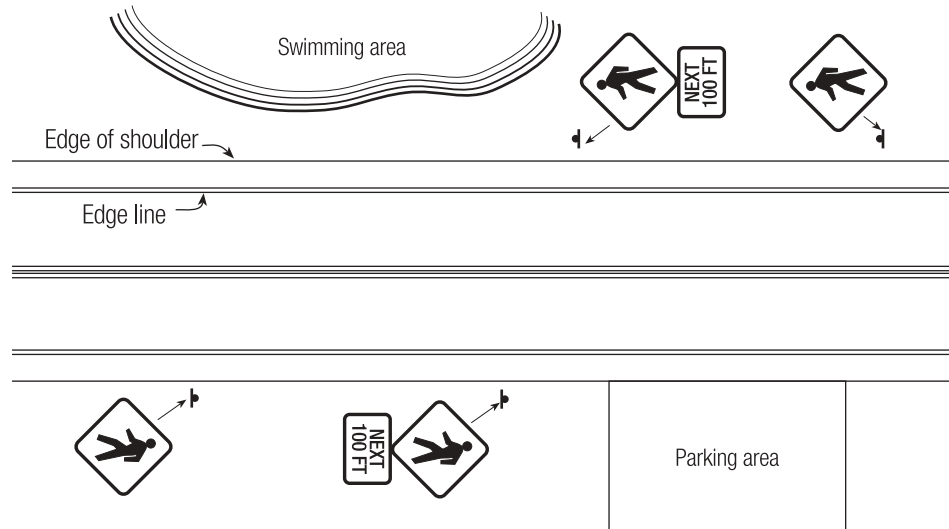

**Figure 3-46.**  
 Unmarked Crossing, Case B – Short Distance.

**Case C — Specific Site.** The pedestrian activity occurs at a specific location but does not meet the guidelines for a marked crossing.

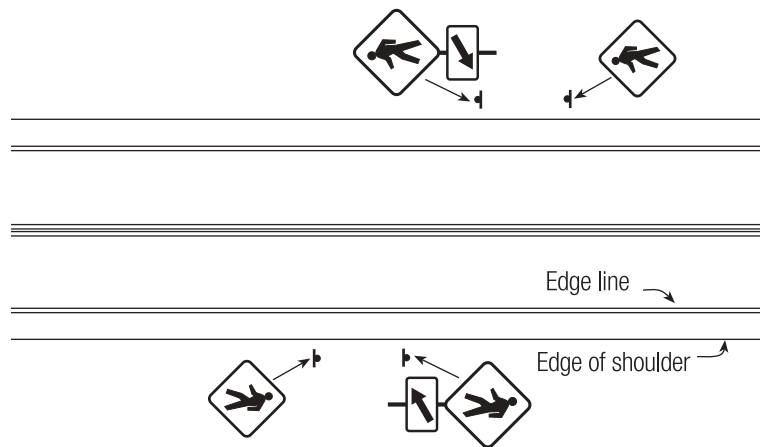

**Figure 3-47.**  
 Unmarked Crossing, Case C – Specific Site.

A pedestrian crossing sign assembly (W11-2 with diagonal arrow W16-7) may be used to supplement advance crossing signs (W11-2) as a means of assisting motorists in distinguishing the specific point of crossing. Such signs should be used only at locations that are unusually hazardous or at locations not readily apparent. Where used, the pedestrian crossing sign assembly (W11-2 with diagonal arrow W16-7) should be located immediately adjacent to the crossing location (see figure). If the crossing area extends for more than 15 m (50 ft), then Case B applies.

### 3.5.6 Medians, Refuge Islands and Slip Lanes

#### Medians and Refuge Islands

Medians and center refuge islands at intersections and midblock locations provide a waiting area for pedestrians, and eliminate the need for pedestrians to cross both directions of traffic at once. They help define the pedestrian walking space and, if large enough, provide protection and refuge from motor vehicles.



This is particularly important on wide, higher-speed roadways and at intersections with complex vehicle movements or long signal phases. Pedestrians trying to cross an undivided, multilane street may experience delays many times longer than the delay incurred crossing a street with a median. Streets with raised medians, in both central business districts and suburban areas, have lower pedestrian crash rates compared to streets with a painted two-way left-turn lane or undivided streets.

Medians and refuge islands are a benefit to drivers when located at midblock crossings, because they help to better identify the upcoming crossing point. They also provide a location for a pedestrian crossing sign in the middle of the street, providing another opportunity to warn drivers of the crossing.

Refuge islands are typically shorter than medians, but either can be used at intersections. Medians and center refuge islands provide the benefit of turning a two-way street into two one-way streets from the perspective of the pedestrian. Medians and refuge islands are preferred where the length of crossing exceeds 18 m (60 ft), depending on signal timing, but can be used at intersections with shorter crossing distances where a need has been determined. Refuge islands are particularly useful when used in conjunction with uncontrolled mid-block crossings.

The preferred design of medians and refuge islands follows ITE's *Design and Safety of Pedestrian Facilities* guidelines:

- Medians and refuge islands have a preferred width of 2.4 to 3.0 m (8 to 10 ft) and a minimum width of 1.8 m (6 ft) to hold wheelchairs propelled by attendants, bicyclists, and people with strollers outside the travel lanes. In some cases, smaller width medians and refuge islands may be acceptable where there is a severely constrained right-of-way.
- In order to obtain appropriate median width, travel lanes can be narrowed to minimum widths as outlined in the VT State Standards. This can have the added effect of slowing motor vehicle speeds at the crossing location. On the state highway system a minimum single lane curb to curb distance of 14 ft should be maintained to accommodate snow removal.

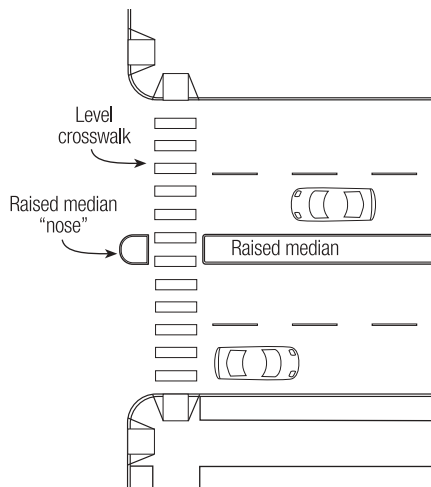

**Figure 3-48.**  
Intersection Median/Refuge



Medians and center refuge islands at intersections and midblock locations provide a waiting area for pedestrians and eliminate the need for pedestrians to cross both directions of traffic at once.

- Trees in medians and at the sides of streets can help to narrow the long-range field of vision for approaching drivers, causing them to slow down as they near the crossing point. Landscaping in median refuge islands must not block the

sight lines of pedestrians and motorists at the crossing area.

- Curb ramps or full cut-throughs should be installed in all median refuge islands per ADA guidelines (refer to Section 3.4.6, Curb Ramps). Cut-throughs are more common because the median width is often not large enough to accommodate ramps and level landings that meet the ADA requirements. Cut-throughs should be designed with a 1:48 (2 percent) cross-slope to allow water, silt, and debris to drain from the area. Islands with ramps should have a level area at least 1.2 m (4 ft) long at the same level as the top of the raised median to provide a level area for wheelchair users.
- A pedestrian push button should be placed in the median of signalized midblock crossings where the crossing distance exceeds 18 m (60 ft) or where high numbers of elderly or people with disabilities are expected.
- Medians and refuge islands should be illuminated.
- At intersections, an approach “nose” can protect the crosswalk. The nose is offset from the edge of the traffic lane and appropriately marked to provide motorists with sufficient warning. This can be achieved through various considerations such as illumination, reflectorization, marking, signing, and size. The location and dimension of the “nose” should consider expected vehicle turning movements.

### Slip Lanes

Slip lanes, or right-turn channelization lanes, allow right-turning motor vehicles to proceed without stopping and, generally, at a higher speed than if they had to make a 90-degree right turn. While slip lanes are generally not helpful to pedestrians due to the emphasis on easy and fast vehicle travel, they can be designed to be less problematic.

At large intersections, pedestrians can have difficulty crossing due to right-turn movements and wide crossing distances. A well designed slip lane provides a pedestrian crossing island within the intersection and a right-turn lane that is designed to optimize the motorist’s view of the pedestrian and of vehicles to their left. Pedestrians are able to cross the slip lane and wait on the refuge island for their walk signal. Since the traffic signal is timed based on a shorter crossing, the pedestrian crossing time has a smaller influence on the signal timing.

This design has an additional advantage for the pedestrian because the crosswalk is located in an area where the driver is still looking ahead. Older designs placed the crosswalk too far into the turn, where the driver is already looking left for a break in the traffic.

The slip lane should be based on a compound curve designed to discourage high-speed turns, while accommodating large trucks and buses — similar to the geometry of a roundabout approach where sharp deflection occurs just after the crosswalk (refer to Section 7.2.4, Roundabouts). The island for the slip lane should be a triangular “pork chop” with the “tail” pointing to approaching traffic, similar to a roundabout’s splitter island.

At large intersections without a slip lane, there is often a triangular space between the through-lane and the right-turn lane that is unused by motorists. Placing a raised island in this area provides pedestrians a refuge area when crossing (see Figure 3-49). This may be an appropriate solution when curb return radii of larger than 9 m (30 ft) are unavoidable. In such cases a well-engineered slip lane will improve intersection operation and safety.

Burlington



Well-designed slip lanes provide pedestrian crossing islands within the intersection and optimize motorists’ view of pedestrians.

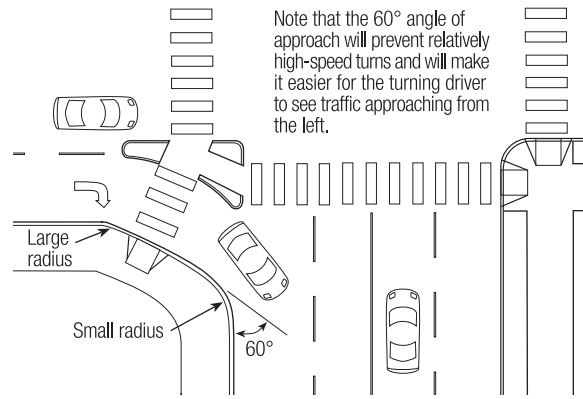

**Figure 3-49.**  
Right-Turn Lane and Pedestrian Refuge

Where slip lanes are used and a refuge island is provided, it should be raised to provide a vertical barrier and added protection between vehicles and pedestrians. Refuge islands need to provide curb ramps, or cut-throughs (preferred), for accessible passage. Pedestrian pushbuttons may be needed when the signal timing doesn't allow all pedestrians to cross the street on one crossing phase.

### 3.5.7 Curb Extensions

Curb extensions — also known as bulbouts, neckdowns, flares, or chokers — reduce the pedestrian crossing distance and improve the visibility of pedestrians to motorists and vice versa. Consider installing curb extensions at any intersection where on-street parking is allowed. The crossing distance savings are greatest when used on streets with diagonal parking. On arterials and collectors, space should be provided for existing or planned bicycle lanes.

Curb extensions and bulbouts work particularly well on streets where there is limited turning traffic by buses and large vehicles, or streets that accommodate one-way traffic, and on minor streets in residential areas. Curb extensions typically have the effect of reducing the curb radius.

Reducing pedestrian crossing distance improves signal timing if the pedestrian phase controls the signal. The time saved is substantial when two corners can be treated with curb extensions.

Corning, NY



**Curb extensions reduce pedestrian crossing distances and improve visibility for pedestrians and motorists alike.**

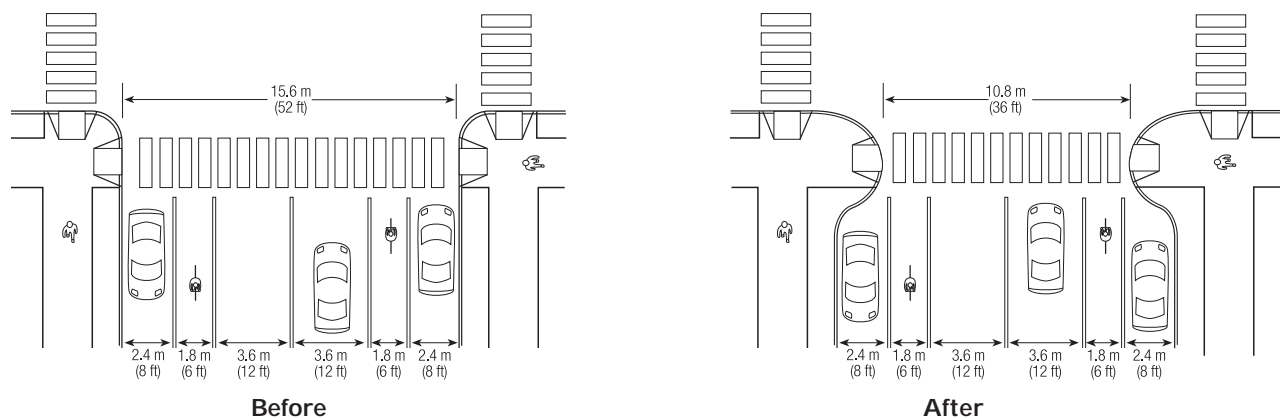

**Figure 3-50.**  
Curb Extensions.  
Curb extensions reduce crossing distance.

Curb extensions at intersections or mid-block offer the following positive features:

- Reduce the distance that pedestrians must cross, lessening the time that they are exposed to traffic.
- Improve the ability of motorists and pedestrians to see one another.
- Increased ability to use paired curb ramps at intersections.
- Provide space for street furniture or utility infrastructure.
- Provide a traffic calming effect along the roadway.

One negative effect is that curb extensions do result in slightly more complex snow removal.

### 3.5.8 Midblock Crossings

In areas where distances between intersections are long, midblock crossing points can provide pedestrians opportunities to cross safely. Midblock crossings can also provide convenience and safety in less developed areas where pedestrian activity is high (such as between a school and a residential area, housing and a grocery store, or a bus stop and a shopping center). Most pedestrians, especially children, will not go far out of their way to cross a street. Well-placed midblock crossings can reduce the tendency of pedestrians to cross at unexpected locations.

The location of a proposed midblock crossing should be based on an engineering study with active public involvement. The following locations may be suitable for midblock crossings:

- Where significant pedestrian crossings and substantial pedestrian-vehicle conflicts exist.
- Where the crossing can serve to concentrate or channelize multiple pedestrian crossings to a single location.
- At school crossings.
- Where land uses create high concentrations of pedestrians waiting to cross, such as residential areas across from retail or recreation, and transit stops across from residential areas or employment.
- Where there is a need to delineate the optimal location to cross.
- Where there is adequate sight distance for the motorist and pedestrian. Any obstacles that would interfere with visibility at the crossing location (mailboxes, utility poles, street furniture, signs, and landscaping) should be removed or relocated. On-street parking should be set back from the crossing point by 20 ft for improved visibility or a curb extension installed.

Midblock crossings should generally be avoided under the following circumstances (unless they are stop-controlled):

- Immediately downstream, less than 90 m (300 ft) from a traffic signal or bus stop, and where motorists are not expecting pedestrians to cross.
- Within 90 m (300 ft) of another crossing point, except in central business districts or other locations where there is a well-defined need.
- On high-speed streets with speed limits above 64 km/h (40 mph).

#### Design

Crossing design treatments are often used in combination with one another at midblock crossings. Standard practices as well as some more innovative techniques are being tested around the country. Determining methods of crossing design treatments and related traffic control requires careful consideration and traffic engineer-

Williston



**In areas where distances between intersections are long, midblock crossings can provide pedestrians opportunities to cross safely.**

ing analysis of existing conditions on a project-by-project basis.

**Marked crosswalks.** Midblock crosswalks should always be marked with highly visible crosswalks. Block, ladder, or diagonal markings are highly recommended because of their high visibility. In refuge islands and medians, angling the crossing encourages pedestrians to view oncoming traffic (refer to Figure 3-51).

**Midblock pedestrian-actuated signals.** The MUTCD bases the need for pedestrian crossing signals on the number of adequate gaps or space between the vehicles in the roadway's traffic stream. It states that, for signalized crossings, pedestrians must wait for a gap in traffic that is of sufficient duration to permit crossing without interference from vehicular traffic. When adequate gaps occur less frequently than an average of once per minute, some form of traffic control is necessary.

Pedestrian-actuated signals are often appropriate for roadways that have high traffic volumes or speeds, or four or more lanes. Since these signals only operate in the presence of foot traffic, they do not cause undue delay to vehicles during periods of low pedestrian volumes. Pedestrian-actuated signals should be considered in locations where mid-block crossings are provided on major arterials or other high-volume or high-speed facilities. MUTCD warrants will need to be met before any signal can be installed. Section 4 of the MUTCD also contains specific requirements for any signal installation.

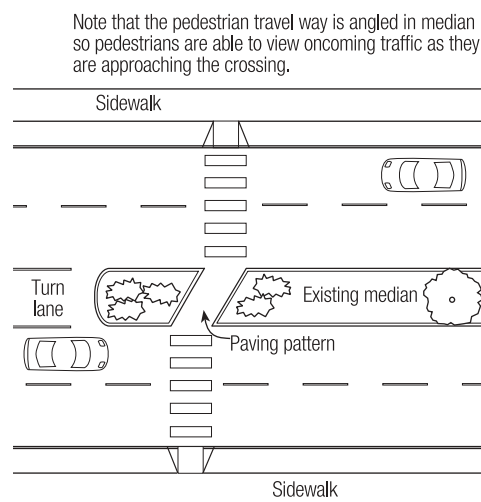

**Figure 3-51.**  
Midblock Crossing of an Arterial Street

**Raised midblock crossings.** Raised midblock crossings (or speed tables, refer to Chapter 7) are sometimes constructed to provide a well-defined pedestrian crossing as well as traffic calming. This type of crossing is only suitable for low-speed, low-volume local streets.

Raised crossings enhance pedestrian safety by creating a vertical pavement undulation that forces motorists to slow down when approaching. Raised crossings function as an extension of the sidewalk and allow pedestrians to cross at a constant grade, without the need for curb ramps or median cut-throughs. Raised crossings should have a 1.8 m (6 ft) parabolic approach transition, raising the vehicle 8 to 10 cm (3 to 4 in) above the nominal pavement grade. The flat section of the crossing table should be 3.0 to 3.7 m (10 to 12 ft) wide.

Raised crossings need to be highly visible, either striped as a midblock crossing or constructed of a contrasting pavement design. Raised crossings should be signed

with advance warning signs and pedestrian crossing signs in the same manner as other midblock crossings.

**Flashing beacons.** A crosswalk with a flashing beacon provides a relatively low-cost treatment for midblock pedestrian crossings. These devices are authorized by the MUTCD under the sections related to hazard identification beacons. The flashing light alerts drivers in advance of potential pedestrians without forcing them to stop, unless there is actually a pedestrian in the crosswalk. This sort of device can be used on roadways with higher vehicular volumes without causing undue delay to drivers.

VTrans policy on where flashing beacons can be installed includes the following four criteria:

1. The location has an accident rate above the statewide average rate for comparable highways. Analyses must show that the types of accidents occurring are correctable by the installation of a flashing beacon.
2. Sight distance to the location of significant pedestrian or animal crossing is less than the stopping sight distance required for the prevailing vehicle speeds.
3. In conjunction with school speed limits “when flashing” as determined by the Traffic Committee.
4. At any other location where the Agency determines that a unique hazard exists.

Flashing beacons are most effective if they are operating only during times when there is a clear need to alert the motorist, such as when pedestrians are actually present (rather than constantly flashing).

**Advance warning signs and pedestrian crossing signs.** Advance Pedestrian Crossing sign assemblies (W11-2 with supplemental plaque W16-9p or W16-2 or W16-2a) should be installed in advance of midblock crossings. Placement of advance warning signs depends on the posted speed of the roadway and other conditions, such as available sight distance. Refer to the MUTCD for sign placement criteria.

Install a pedestrian crossing sign assembly (W11-2 with diagonal arrow W16-7) at a midblock crosswalk location where unexpected entry into the roadway by pedestrians may occur.

**Other design considerations.** It is usually necessary to supplement the existing street lighting system with additional lighting at new midblock crossing locations. It is extremely important that these crossing locations be well-illuminated, so they are clearly visible to motorists driving at night.

### 3.5.9 Illumination

Lighting of streets and highways — and of the adjacent sidewalks, walkways, and shoulders — increases pedestrians’ safety, security and comfort and encourages walking. Typically, the street lighting system in urban areas provides adequate illumination for pedestrians, although conditions can be enhanced by providing such things as additional ground-level lighting.

Where a new lighting system is being introduced either to replace or supplement the existing street light system, it may be possible to incorporate light posts and fixtures that are more pedestrian oriented (shorter and more in scale with pedestrians, or lower intensity light sources). Additional lighting is usually desirable at pedestrian crossing points, such as at marked crosswalks, and at entrances to buildings. It is generally recommended that a level of lighting between 0.5 and 2.0 ft-candles be provided along pedestrian travel ways. Refer to the standards and design guidelines of the Illuminating Engineering Society of North America and the VTrans

Roadway Lighting Policy (November 27, 1991).

### **3.5.10 Signalized Pedestrian Crossings**

Signalized pedestrian crossings can provide a greater degree of protection from conflicting motor vehicle traffic. At signalized intersections with adjoining pedestrian facilities, pedestrian signal heads and phases are incorporated into the overall signal design. In some cases, a mid-block pedestrian signal may be warranted. Pedestrian signals should be timed to accommodate walking speeds of the majority of users expected to use a crossing. In areas where a high percentage of elderly pedestrians or pedestrians with disabilities are expected, slower walking speeds should be used. For a complete discussion of pedestrian signals, refer to Section 8.2.3, Signals.

### **3.5.11 Grade-Separated Crossings**

Grade-separated crossings refer to facilities that provide for pedestrians and motor vehicles to cross at different levels, such as overpasses and underpasses. They allow for the uninterrupted flow of pedestrian movement separate from the vehicle traffic. Because grade-separated crossings are very expensive and have limited applications, they should be a measure of last resort.

Grade separation is most feasible in extreme cases where pedestrians must cross a major highway, a rail yard, railroads or a water way. For most streets it is more appropriate to use traffic calming measures (refer to Chapter 7) or install a pedestrian-activated signal (refer to Chapter 8) for an at-grade crossing.

Overpasses work best when the topography allows for a structure without ramps (e.g., an overpass over a sunken highway). Underpasses work best when designed to feel open and accessible; it is essential that they are well lighted to address the security concerns of pedestrians

Overpasses must accommodate all people as required by ADAAG. These measures include ramps or elevators. The extensive ramping required to accommodate wheelchairs will also accommodate bicyclists, but the long crossing distance and elevation gain discourages use. Studies have shown that many pedestrians will not use an overpass or underpass if they can cross at street level in about the same amount of time.

### **3.5.12 Construction Zones and Temporary Access**

When construction zones encroach on sidewalks or crosswalks, pedestrians may suddenly find themselves having to make detours that may be unsafe, difficult to navigate or both. Because pedestrians are reluctant to retrace their steps, they may choose between picking their way through the construction site or walking in a busy street. This can be especially dangerous for the elderly and people with disabilities, who rely on well-maintained, well-marked sidewalks for safe mobility. Adding to the problem is when projects are built in phases and when construction zones change weekly or even daily. For a more detailed discussion, refer to section 8.2.5.

## ***3.6 Additional Resources***

Consult the following resources for the broadest coverage of issues relating to the planning and design of pedestrian facilities:

- *A Policy on Geometric Design of Highways and Streets* (The Green Book), American Association of State Highway and Transportation Officials (AASHTO), Washington, DC.2001.
- *Americans with Disabilities Act (ADA)* Federal Requirements.

- *Designing Sidewalks and Trails for Access: Best Practices Design Guide*, Federal Highway Administration, 2000.
- *Great Streets*, Allan B. Jacobs, MIT Press, Cambridge, MA. 1993.
- *Guide for the Development of Bicycle Facilities*, , American Association of State Highway and Transportation Officials (AASHTO), Washington, DC. 1999.
- *Guide for the Planning, Design and Operation of Pedestrian Facilities* (Draft), American Association of State Highway and Transportation Officials (AASHTO), Washington, DC. 2001.
- *Manual on Uniform Traffic Control Devices*, Millennium Edition, Available only from AASHTO, ITE and ATSSA or by downloading this document from the Internet.
- *Pedestrian and Bicycle Crash Types of the Early 1990s*, Federal Highway Administration, 1996.
- *Pedestrian Facilities Guide - Providing Safety and Mobility*, UNC Highway Safety Research Center for the Federal Highway Administration, August 2000.



CHAPTER 4



# On-Road Bicycle Facilities

## *Contents*

- 4.1 Introduction ..... 4-3
  - 4.1.1 Application ..... 4-3
- 4.2 Design Considerations ..... 4-3
  - 4.2.1 Bicycle and User Characteristics ..... 4-3
  - 4.2.2 Bicycle Crash Types ..... 4-7
  - 4.2.3 Types of On-Road Bikeway Facilities and Treatments ..... 4-8
  - 4.2.4 Selecting Appropriate Bicycle Facilities ..... 4-9
- 4.3 Bicycle Lanes ..... 4-11
  - 4.3.1 Design Considerations ..... 4-11
  - 4.3.2 Width ..... 4-12
  - 4.3.3 Practices to Avoid ..... 4-15
  - 4.3.4 Bicycle Lanes at Intersections ..... 4-16
  - 4.3.5 Bicycle Lanes and Turning Movements ..... 4-18
  - 4.3.6 Interchange Areas ..... 4-20
  - 4.3.7 Contra-Flow Bicycle Lanes ..... 4-21
  - 4.3.8 Effect of Grades on Bicycle Lanes ..... 4-23
- 4.4 Wide Curb Lanes ..... 4-23
  - 4.4.1 Design Considerations ..... 4-23
  - 4.4.2 Width ..... 4-23
- 4.5 Paved Shoulders ..... 4-24
  - 4.5.1 Design Considerations ..... 4-25
  - 4.5.2 Width ..... 4-25
- 4.6 Shared Lanes ..... 4-26
  - 4.6.1 Design Considerations ..... 4-27
  - 4.6.2 Width ..... 4-27
  - 4.6.3 Unpaved Roads ..... 4-28
- 4.7 Incremental Improvements ..... 4-28
- 4.8 Reallocating Road Space ..... 4-29
- 4.9 Other Considerations for On-road Bicycle Facilities ..... 4-30
  - 4.9.1 Drainage and Drainage Grates ..... 4-30
  - 4.9.2 Railroad Crossings ..... 4-31
  - 4.9.3 Bridges and Undercrossings ..... 4-32
  - 4.9.4 Rumble Strips ..... 4-33
  - 4.9.5 Guard Rails ..... 4-34
  - 4.9.6 Work Zones and Temporary Traffic Controls ..... 4-35
- 4.10 Additional Measures to Improve On-road Bicycling ..... 4-35
  - 4.10.1 Bicycle Route Maps ..... 4-35
- 4.11 Additional Resources ..... 4-35

*On-Road Bicycle Facilities***Figures**

4-1	Bicycle Styles and Dimensions .....	4-4
4-2	Bicyclist's Operating Space .....	4-6
4-3	Bicycle Lane Symbol and Signs .....	4-12
4-4	Bicycle Lane, Curbed Street, No Parking.....	4-13
4-5	Bicycle Lane, Curbed Street, With Parking .....	4-13
4-6	Bicycle Lane, Street or Highway, No Curb, No Parking .....	4-14
4-7	Bicycle Lane, Street or Highway, No Curb, With Parking .....	4-14
4-8	Lateral Transition from Roadway to a Bridge Sidewalk.....	4-15
4-9A	Typical Pavement Markings for Bicycle Lanes on a Two-Way Street with No Crosswalks .	4-16
4-9B	Typical Pavement Markings for Bicycle Lanes on a Two-Way Street with Crosswalks .....	4-17
4-10A	Typical Pavement Markings for Bicycle Lanes at T-Intersections with No Marked Crosswalks .....	4-17
4-10B	Typical Pavement Markings for Bicycle Lanes at T-Intersections with Marked Crosswalks	4-18
4-11	Typical Bicycle and Motor Vehicle Movements at Major Intersections .....	4-18
4-12A	Bicycle Lane with Developed Right Turn Lane .....	4-19
4-12B	Bicycle Lane and Dropped Parking Lane .....	4-19
4-12C	Intersection Widening without Bicycle Lane .....	4-19
4-13A	Typical Pavement Markings for Bicycle Lanes Approaching High-Speed Ramps.....	4-20
4-13B	Typical Pavement Markings for Bicycle Lanes Approaching High-Speed Ramps.....	4-20
4-13C	Typical Pavement Markings for Bicycle Lanes Approaching High-Speed Ramps.....	4-20
4-13D	Off-Ramp with Bike Lane Signs and Pavement Markings .....	4-21
4-14	Typical Signs and Pavement Markings for Contra-Flow Bicycle Lanes.....	4-22
4-15	Wide Curb Lane, No Parking .....	4-23
4-16	Wide Curb Lane, With Parking.....	4-24
4-17	Paved Shoulders .....	4-26
4-18	Shared Lanes .....	4-27
4-19A	Going From Two Travel Lanes in Each Direction to One Each Direction with Continuous Two-way Left Turn Lane .....	4-29
4-19B	Going From Two Travel Lanes with Median to No Median .....	4-29
4-19C	Narrowed Four-Lane Section to Add Bicycle Lanes.....	4-29
4-20	Reevaluating the Need for Parking .....	4-30
4-21	Recessed Drainage Grate .....	4-31
4-22	Ridable Railroad Crossing for Acute Angle .....	4-32
4-23	Ridable Railroad Crossing for Obtuse Angle.....	4-32
4-24	Railroad Flange Filler.....	4-32
4-25	Sign Warning Bicyclists of Railroad Tracks .....	4-32
4-26	Hazardous Railroad Crossings Sign .....	4-33
4-27	Rumble Strips.....	4-34

**Tables**

4-1	User Characteristics and Speeds .....	4-6
4-2	Bicycle Crash Types, Specific Circumstances Group .....	4-7
4-3	Bicycle Crash Types, Bicycle and Motor Vehicle on Parallel Paths Group .....	4-7
4-4	Bicycle Crash Types, Bicycle and Motor Vehicle on Crossing Paths Group .....	4-8
4-5	Bicycle Lane, Curbed Street, No Parking.....	4-13
4-6	Bicycle Lane, Curbed Street, With Parking .....	4-13
4-7	Bicycle Lane, Street or Highway, No curb, No Parking .....	4-14
4-8	Bicycle Lane, Street or Highway, No Curb, With Parking .....	4-14
4-9	Wide Curb Lane .....	4-24
4-10	Paved Shoulders .....	4-26



## 4.1 Introduction

This chapter covers on-road bicycle facilities — bicycle lanes, wide curb lanes, paved shoulders, and shared lanes — as well as related improvements and enhancements. Bicycle facilities that are well separated from the roadway such as shared use paths are discussed in Chapter 5, Shared Use Paths. Guidance on rail-trail conversions and rails-with-trails is provided in Chapter 6, Rail Trails.

### 4.1.1 Application

Most bicycling occurs on existing streets and roads because these facilities connect all destinations directly. Bicycle use is allowed on all roads in Vermont except for limited access highways where bicycles are legally prohibited. Therefore, all highways, except those where bicyclists are legally prohibited, should be designed and constructed under the assumption that they will be used by bicyclists. Bicycles should be considered in all phases of transportation planning, new highway design, highway reconstruction, and capacity improvement and transit projects.

The most effective way to improve conditions for bicyclists and integrate them into the transportation system is to accommodate bicycle travel on all new and existing highways. Even if it were desirable to create a system of bikeways separated from the highway it would not be practical or affordable. Shared use paths and rail trails should be thought of as a complementary system of off-road routes for bicyclists and others that serves as an extension to the roadway network. Separated facilities should not be used to preclude on-road bicycle facilities. Rather they should be used to supplement on-road bikeways.

In general, low volume rural roads satisfactorily accommodate large numbers of bicyclists annually and could better accommodate cycling through the implementation of marginal improvements. On higher volume rural roads, paved shoulders provide increased operating width for bicyclists and motorists as do bicycle lanes on major streets in downtown and village settings. Wide curb lanes and shared roadways are used where width constraints prevent the development of separate lanes or paved shoulders of adequate width to serve bicyclists.

## 4.2 Design Considerations

### 4.2.1 Bicycle and User Characteristics

#### Bicycle Characteristics

**Bicycle Styles and Dimensions.** The three most popular styles of multi-gear adult bicycles available today are: the road bike (also called a touring or racing bike), the mountain bike (characterized by wide, fat smooth or knobby tires) and the hybrid bike (which blends the agility of the road bike and the durability and upright riding position of the mountain bike).

Variations of these styles abound with regard to gearing, passenger and baggage carrying capability, and rider position.

Monkton



Rutland



Lyndonville



Accommodating bicycles begins with the understanding that bicyclists vary greatly in age, skill, dimensions and needs.

Use the following criteria and the dimensions illustrated in Figure 4-1 to determine typical requirements for facility design and storage details:

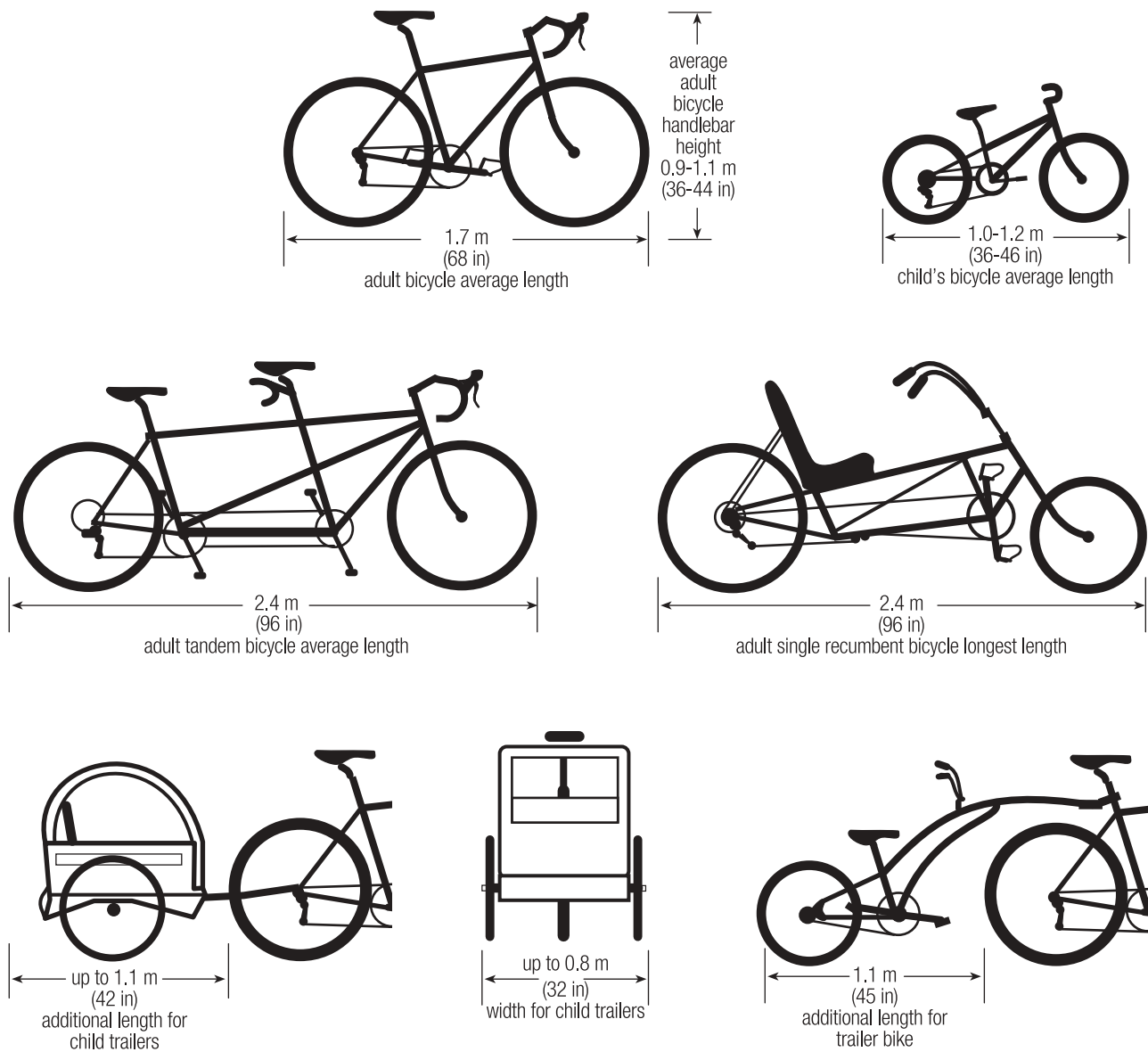

**Figure 4-1.**  
 Bicycle Styles and Dimensions.



An adult tandem bicycle averages 2.4 m (96 in) in length and can easily attain a speed in excess of 50 km/h (30 mph) on even a modest downhill.

**Wheels and tires.** The wheels and tires of a bicycle are narrow and sensitive to variations, imperfections and debris in the riding surface. In addition, the pressure in bicycle tires is high compared to other, larger vehicles. This makes bicycle tires more susceptible to damage and punctures from potholes, small pieces of glass, sharp stones and pieces of metal. Sensitive to these characteristics, bicyclists sometimes must suddenly swerve to avoid an obstacle in their path, a maneuver that may appear unpredictable or erratic to a motorist sharing the same lane.

Design considerations include:

- Minimal tire surface contact with the ground (as little as 2 sq cm or 0.3 sq in.).
- Road shock transmitted directly through the bicycle to the rider (many bicycles

do not have suspensions systems).

- Sand, mud, algae, snow, wet or icy leaves, metal utility covers and decking, and skewed railroad tracks can precipitate a crash.
- Longitudinal seams and cracks (as narrow as 6 mm or 0.25 in) can cause loss of control.
- Surface edges and objects higher than 12 mm (0.5 in) can damage some rims or cause a crash.
- Underlying concrete roadways, which are common in Vermont, often create longitudinal cracks that wander on and off the shoulder and pose a significant hazard to bicyclists.

### **Brakes and braking.**

Design considerations include:

- Reaction and braking times vary widely among users (allow 2.5 sec normal reaction time, allow 3.0 sec more for a surprised reaction time).
- Application of the brake and mechanical delay can account for 1.5 sec of additional braking time.
- Maximum deceleration for a bicycle is 17 km/s<sup>2</sup> (11 mph per sec).
- When rims are wet or coaster brakes are used, performance is 50 to 80 percent less efficient.

**Steering.** Bicyclists maintain balance by steering the front wheel of the bicycle under the combined center of gravity of both bicycle and rider.

Consequently, emergency or evasive steering maneuvers cannot be accomplished quickly by most bicyclists. The initiation of an intentional sudden turn is counter-intuitive (i.e., the rider must sharply steer the front wheel out from under the center of gravity in the opposite direction he or she intends to go to set up the sudden turn).

Design considerations include:

- Emergency turns cannot be accomplished as quickly on a bicycle as in an automobile.
- To initiate a turn the operator must first steer the bicycle in the opposite direction to set up a counter lean (precipitating a controlled fall).
- Allow 1.5 sec to set up a normal turn.
- Bicycles steer more slowly when heavily loaded.
- The lower the center of gravity the more stable the bicycle (high loads such as rider-mounted backpacks and bicycle-mounted child seats raise the center of gravity and make a bicycle less stable).

**Tracking widths and grades.** Due to steering wobble, bicyclists may track over a 1.0 m (40 in) width. An increase in climbing grade can generate more wheel wobble due to the slower speed, requiring even more operating width. Also, extra operating width on descents can allow bicyclists to more safely avoid debris or surface hazards at higher speeds. Therefore, where practicable, it is desirable to provide a paved shoulder or bicycle lane at least 1.8 m (6 ft) in width on uphill and downhill grades that exceed 5 percent to provide bicyclists with additional space for maneuvering.

With multi-gear bicycles, many bicyclists can comfortably manage 10 percent grades for short distances. Experienced bicyclists can accomplish steeper grades for much longer distances (e.g., the 13 percent grade on Vermont Route 132 between

South Strafford and Sharon). Grades of 5 percent are the more common limit, with grades of 4 percent or less preferred by the majority of bicyclists.

Design considerations include:

- Average operating width on level terrain is 1 m (40 in).
- Average operating width over hilly terrain is 1.2 to 1.4 m (4 to 6 ft).
- Preferred grade is 4 percent (1:25) or less.
- Acceptable grades over limited distances range from 6 to 10 percent (1:16 to 1:10).

### User Characteristics

Although riders vary greatly in age, skill, dimensions and needs, the characteristics below encompass virtually all bicyclists:

**Table 4-1.**  
User Characteristics and Speeds.

User Characteristics	Metric	English
Design viewing height	1.35 m	54 in
Center of gravity (adult, child varies)	0.84-1.02 m	33-40 in
<b>Speeds (by age)</b>	<b>Metric</b>	<b>English</b>
Child (4-8 years)	10-14 km/h	6-9 mph
Youth (9-12 years)	11-17 km/h	7-11 mph
Young adult (13-18 years)	13-24 km/h	8-15 mph
Adult	13-24 km/h	8-15 mph
Proficient adult	19-38 km/h	12-24 mph
Senior adult	13-24 km/h	8-15 mph
Cycling club pace lines	24-50 km/h	15-30 mph
<b>Design speeds</b>	<b>Metric</b>	<b>English</b>
Design speed (crossing intersections)	15 km/h	10 mph
Design speed (level terrain — paved)	30 km/h	20 mph
Design speed (unpaved)	24 km/h	15 mph
Design speed (downhill)	50 km/h	30 mph
Design speed (uphill)	8-19 km/h	5-12 mph

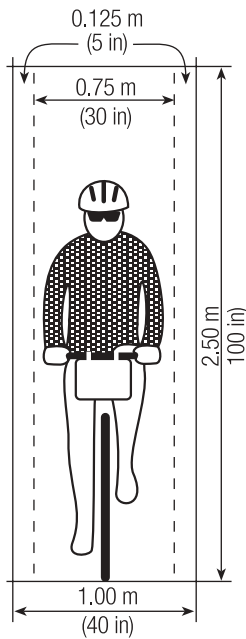

**Figure 4-2.**  
Bicyclist's Operating Space



The slender profile of bicyclists may make them difficult for motorists to see, especially in complex visual situations.

**Profile and visibility.** Most motorists involved in car-bicycle crashes report they did not see the bicyclist before the crash. Their slender profile (and sometimes low height) of bicyclists may make them difficult to see, especially in complex visual situations. The problem is even worse in low light conditions or at night. Bicyclists can improve their own visibility by making sure their bicycles are properly equipped with reflectors, wearing bright clothing, using retro-reflective fabrics, using flashing tail lights at night, and using headlights at night. However, motorists need to be on the lookout for bicyclists. Ultimately, increased bicycle use will result in increased motorist awareness.

Considerations for design include:

- Bicyclists exhibit a thin or low profile.
- Their curbside location can reduce their being seen by overtaking, turning or parked motorists.
- Signs and stripes can warn motorists to expect increased bicycle use.
- Even when using lights, bicyclists are extremely difficult to detect under low light conditions or at night time.
- Motorists should be trained and expected to detect bicyclists more readily.

### 4.2.2 Bicycle Crash Types

Approximately 900 bicyclists are killed each year in motor vehicle crashes nationwide. This is but a fraction of the injuries that occur from car-bike crashes. According to *Pedestrian and Bicycle Crash Types of the Early 1990s (1996)*, 1991 data from the General Estimates System indicated that an additional 67,000 bicyclists reported injuries as a result of colliding with a motor vehicle. Many more injuries go unreported. A study by Stutts, et al. (1990) showed that fewer than two-thirds of bicycle-motor vehicle crashes were serious enough to require emergency room treatment.

In 1996, NHTSA sponsored additional research to further refine and update crash type distributions. This research resulted in a study, *Pedestrian and Bicycle Crash Types of the Early 1990s*, that identified 85 individual crash types, although, through assimilation, all crash types could be grouped into just three crash type groups: 1) specific circumstances; 2) the bicycle and motor vehicle on parallel paths; and 3) the bicycle and motor vehicle on crossing paths.

The **specific circumstances** group accounted for 7 percent of all crashes. Accident sub-types in this group were:

**Table 4-2.**  
Bicycle Crash Types, Specific Circumstances Group.

Specific circumstances group	Percent
Crashes in parking lots and other non-roadway areas	3.7
Other "weird" types	3.2
<b>Group total</b>	<b>6.9</b>

The **bicycle and motor vehicle on parallel paths** group accounted for 36 percent of all crashes. Accident sub-types in this group were:

**Table 4-3.**  
Bicycle Crash Types, Bicycle and Motor Vehicle on Parallel Paths Group.

Bicycle and motor vehicle on parallel paths group	Percent
Motorist turned or merged into path of bicyclist	12.1
Bicyclist turned or merged into path of motorist	7.3
Either operator on wrong side of street	2.8
Motorist overtaking bicyclist	8.6
Bicyclist overtaking motorist	2.7
Motorist loss of control	0.6
Bicyclist loss of control	1.8
<b>Group total</b>	<b>35.9</b>

The **bicycle and motor vehicle on crossing paths** group accounted for 57 percent of all crashes. Accident sub-types in this group were:

**Table 4-4.**  
 Bicycle Crash Types, Bicycle and Motor Vehicle on Crossing Paths Group.

Bicycle and motor vehicle on crossing paths group	Percent
Bicyclist did not clear intersection	1.4
Motorist failed to yield	21.7
Bicyclist failed to yield, midblock rideout	11.7
Bicyclist failed to yield, intersection rideout	16.8
Motorist turning	0.7
Bicyclist turning	0.7
Crash occurred at intersection	4.1
<b>Group total</b>	<b>57.1</b>

Major findings of this study include:

- Driveways and other junctions account for 3 out of 4 crashes. Design facilities with this in mind.
- Young bicyclists under the age of 15 (and particularly 10 to 14) are over-represented in crashes with motor vehicles. Bicyclists older than 44 are over represented with regard to serious and fatal injury.
- Crashes with motor vehicles result in serious and fatal injuries 18 percent of the time.
- Two-thirds of bicycle-motor vehicle crashes occur during late afternoon and evening hours. Exposure is high during this period and visibility can be a problem.
- Two-thirds of the crashes occurred in urban areas.
- About 60 percent of road-related crashes occurred on two-lane roads.
- Roads with narrow lanes and higher speed limits are over-represented with regard to serious and fatal injury.

As a result of the study, the researchers concluded that a system-wide approach — including engineering, education and enforcement — is needed if the goals of the National Bicycling and Walking Study (refer to VTrans Bicycle Policy) are to be met.

### 4.2.3 Types of On-Road Bikeway Facilities and Treatments

The types of on-road bicycle treatments include:

- *Bicycle lane.* A portion of the roadway that has been designated by signs and pavement markings for preferential or exclusive use by bicyclists.
- *Wide curb lane.* A wider than normal travel lane that better accommodate bicycles and motor vehicles in the same lane while providing enough space for motorists to overtake and pass bicyclists without changing travel lanes.
- *Paved shoulder.* —The paved portion of the highway contiguous with the outside travel lane of the roadway that can be used by bicyclists as well as for the accommodation of pedestrians, stopped vehicles, emergency use and the lateral support of sub-base, base and surface courses.
- *Shared lanes.* Travel lanes with no additional width provided for bicyclists.
- *Incremental improvements.* Any change in infrastructure that benefits bicyclists.



including bicycle-safe drainage grates, minimal additional width, signing, pavement markings, etc.

In addition, traffic calming techniques can effectively reduce the speed of motor vehicles along a roadway (refer to Chapter 7, Traffic Calming) and signs and pavement markings may be used to alert motorists of increased bicycling activity in certain locations, designate routes and convey information to bicyclists (see Chapter 8, Signs, Pavement Markings and Signals).

#### 4.2.4 Selecting Appropriate Bicycle Facilities

The wide variation in ability, needs and desires among bicyclists can make it difficult to plan and design facilities that meet all the needs of these users.

Indeed, no one type of bicycle facility or highway design will suit all bicyclists and no bicycle facility can overcome a lack of bicycle operator skill. It is important to recognize that the choice of any one particular design will affect the type of rider that will be attracted to a facility, the level of use along the facility, and the level of access and mobility that will be afforded to bicyclists.

**Design users.** Accommodating bicyclists begins with the understanding that not all bicyclists are alike. The characteristic that best differentiates bicyclists is ability, which may be defined as a combination of skills, knowledge and judgment.

The Bicycle Federation of America estimates that one out of three people (100 million) in the United States own a bicycle, yet it is believed that fewer than 5 percent of these bicycle owners qualify as experienced or highly skilled bicyclists. Therefore, the vast majority of bicycle riders may be considered intermediate and novice bicyclists.

The 1994 FHWA report, *Selecting Roadway Design Treatments to Accommodate Bicyclists*, identified three general categories of bicycle user types (A, B and C) to assist highway designers in choosing different facility types for different roadway conditions for different types of bicyclists. AASHTO recognizes the same bicycle user types in their *Guide for the Development of Bicycle Facilities*.

The three general bicycle user types are:

##### Group A — Advanced Bicyclists

These bicyclists exhibit the following characteristics:

- Experienced riders.
- Have a level of comfort operating in traffic conditions.
- Use existing roadway system.
- Operate at maximum speed with minimum delay.
- Require minimal operating space on the roadway or shoulder to reduce the need for either the bicyclist or the motor vehicle operator to change position when passing.

Group A bicyclists are best served by:

- Wide outside lanes on urban arterials and collectors.
- Usable shoulders on rural highways.

##### Group B — Basic Bicyclists

Group B bicyclists exhibit the following characteristics:

- Casual or new adult or teenage riders.
- Less confident of their ability to operate in traffic without special provisions for bicycles.

The characteristic that best differentiates bicyclists is ability, which may be defined as a combination of skills, knowledge and judgment.



Group A bicyclists include experienced riders who have a level of comfort operating in traffic conditions.



Group B bicyclists are less confident of their ability to operate in traffic without special provisions for bicycles.

- Some will become advanced bicyclists, most will remain basic riders.
- Prefer low-speed, low traffic-volume streets or designated bicycle facilities.

Group B bicyclists are best served by:

- Extra operating space when riding on the roadway.
- Ensuring low speeds on neighborhood streets.
- Network of designated bicycle facilities (bicycle lanes, side-street bicycle routes and shared-use paths).
- Usable shoulders on rural highways.

### Group C — Children

The bicycle riders that comprise Group C share these traits:

- Children, usually pre-teen riders.
- Roadway use initially monitored by parents.
- May not comply with traffic regulations.
- They (and their parents) prefer residential streets with low motor vehicle volumes and speed limits, and well-defined separation of bicycles and motor vehicles or separate pathways.

Group C bicycle riders are best served by:

- Ensuring low speeds on neighborhood streets.
- Extra operating space when riding on the roadway or facilities separated from motor vehicle traffic.
- Network of designated bicycle facilities (bicycle lanes, paved shoulders, side-street bicycle routes, shared use paths, and rail trails).
- Riding on a sidewalk where pedestrians are not endangered or when pedestrian activity is low.

The design values in this chapter are aimed at meeting the needs of all bicyclists including Group B and C riders.

As a goal, a particular bicycle facility design should be chosen to encourage use by the lowest caliber bicyclist expected to frequently use the facility. For basic adult and child bicyclists (Groups B and C), bicycle lanes, wide curb lanes and paved shoulders — facilities that provide extra operating space on a roadway — or an alternate route using neighborhood streets, or shared use paths and rail trails are the design treatments that are favored.

Often, physical constraints are encountered that prevent consideration of these types of facilities. Therefore, design treatments that consume less width may have to be considered. At a minimum, facilities that accommodate the needs of the more skilled Group A bicyclists — shared lanes, paved shoulders and wide curb lanes — should be used as a guide to selecting the minimum design treatment for *any* roadway on which accommodations for bicycles are provided.

Marginal improvements (refer to Section 4.7, Marginal Improvements) should be considered for all roadways on which bicycle use is not prohibited.

### Supplemental Guidance

Two resources that can aid designers in the selection of appropriate on-road bicycle facilities are AASHTO's *Guide for the Development of Bicycle Facilities* and FHWA's *Selecting Roadway Design Treatments to Accommodate Bicycles*.



Group C bicycle riders include children and pre-teens who may not comply with traffic regulations.



*As a goal, a particular bicycle facility design should be chosen to encourage use by the lowest caliber bicyclist expected to frequently use the facility.*

## 4.3 Bicycle Lanes

Bicycle lanes, also called “bike lanes,” are defined in the MUTCD as “a portion of a roadway that has been designated by signs and pavement markings for preferential or exclusive use by bicyclists.” They are most commonly used in urban or village settings where a designated bike facility will aid the orderly flow of motorist and bicyclist traffic. These settings typically include numerous driveways, turning movements or other potential conflicts that indicate that bike lanes are a good design option. Refer to VTrans Standard Drawings for design details.

### Features of Bicycle Lanes

- Are not physically separated from travel lanes.
- Designated by signing and pavement markings (including lane striping and lane symbols).
- Intended for preferential or exclusive use of bicyclists.
- Provides increased operating width for bicyclists.
- Provides for more predictable movements of motorists and bicyclists.
- Motorists and bicyclists are less likely to veer out of their own lanes.
- Vary in width depending on conditions.

### 4.3.1 Design Considerations

- Bicycle lanes should be one-way facilities.
- Bicycle lanes should carry bike traffic in the same direction as adjacent traffic (i.e. on the right side of the street or road).
- Bicycle lanes should never be placed between a parking lane and the curb.
- Pavement surfaces should be level and smooth.
- Where drain inlets and utility covers are present in bicycle lanes, they should be bicycle-safe and adjusted flush with the roadway surface.
- Delineate bicycle lanes from motor vehicle lanes with a 150 mm (6 in) solid white stripe. For added distinction, a 200 mm (8 in) solid white stripe may be used.
- Bicycle lanes should be delineated from parking lanes with a 100 mm (4 in) solid white stripe where no parking lane stripes or tick marks exist.
- Short distance, two-way lanes may be considered where the need to make a double crossing of a busy street or use of a sidewalk might otherwise be required.
- Where bicycle lanes exist in advance of a roundabout terminate bicycle lane striping at the pedestrian crosswalk. See Sections 7.2.3 and 7.2.4 for additional design considerations at roundabouts.

### Bicycle Lane Symbols

General design considerations and recommendations

- Designate bicycle lanes by signing, lane striping and lane symbols:
- Either a bicycle symbol (preferred) or a word legend (optional) may be used as a lane symbol.
- A directional arrow must be used in combination with the bicycle symbol or word legend.
- Center symbols in the bicycle lane.
- Place symbols on the far side of each intersection to alert drivers and bicyclists of the exclusive or preferential nature of the bicycle lane. Symbols shall be placed

South Burlington



Bicycle lanes, designated by signs, stripes and symbols, are intended for the preferential or exclusive use of bicyclists.

no closer than 20 m (65 ft) from the intersection or cross road. Supplementary symbols may be placed on the near-side of an intersection to warn bicyclists not to enter a bicycle lane on the wrong side of the road.

- Place additional symbols periodically along uninterrupted sections of the bicycle lane at the following rate:

**For metric calculations**

Multiply speed in km/h times 7 (e.g., 60 km/h X 7 = approx. 420 m);

**For English calculations**

Multiply speed in mph times 40 (e.g., 35 mph X 40 = approx. 1400 ft).

- In order to increase longevity of the symbol, do not place symbols in areas such as driveways where motor vehicles are expected to travel over the symbol.

The preferred bicycle lane symbol is as shown in Figure 4-3.

Refer to Section 8.3.2, Markings, in Chapter 8, Signs, Pavement Markings and Signals, for additional guidance on approved designs and placement of pavement markings and signs for bicycle lanes.

**4.3.2 Width**

The widths for bicycle lanes in village centers and urban environments appear in Tables 4-6 through 4-9. Greater widths may be required where higher traffic volumes, traffic speeds, heavy vehicles or limited sight distances exist. Also, the width of a bike lane may need to be adjusted where curbing, adjacent on-street parking or other features from which a bicyclist may shy away exist.

Additional bike lane width is recommended where there are 30 or more overtaking heavy vehicles per hour in a single outside lane. Use the following formula to calculate this from existing traffic data.

**How to Calculate the Number of Overtaking Heavy Motor Vehicles per Hour in a Single Outside Lane.**

Heavy vehicle volume is usually expressed in percent AADT. However, use of these percentages alone can be misleading. For example, as much as 25 percent of the traffic using a particular roadway may consist of heavy vehicles. But if the total traffic volume is low, fewer than 30 heavy or large vehicles may overtake a bicyclist within an hour's time. To compute the number of heavy vehicles that will overtake a bicyclist in one hour, use the formula below:

$$HV_{OT} = \frac{[AADT \times SP_V] [R_{HV} - R_B]}{[SP_T \times L] [R_{HV}]} \times HV\%$$

Where:

- $HV_{OT}$  = Number of overtaking heavy vehicles per hour
- AADT = Total traffic volume (both directions)
- $SP_V$  = Percent share of the traffic volume per study period (typically 0.4 or 40 percent)
- $SP_T$  = Length of study period in hours (typically 7 hours from 9 a.m. to 4 p.m.)
- L = total number of travel lanes in both directions (typically 2 as trucks tend to travel in outside lanes)
- $R_{HV}$  = Rate of the faster moving heavy vehicle (in miles per hour)
- $R_B$  = Rate of slower moving bicycle vehicle (typically 10 miles per hour)
- HV% = Percentage of heavy vehicles (expressed in a percentage of AADT)

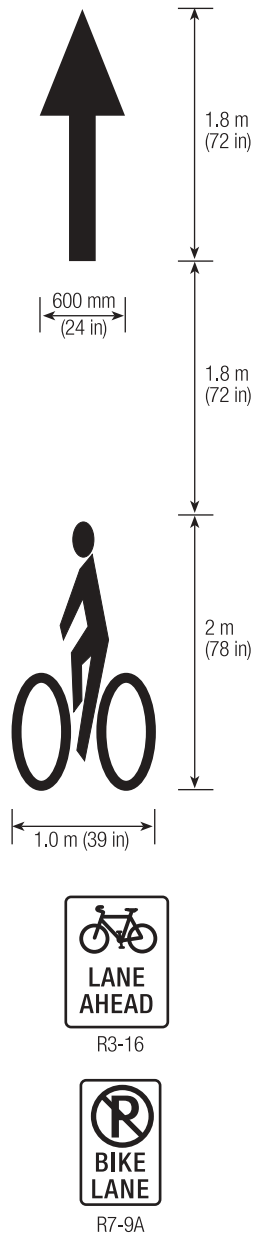

**Figure 4-3**  
Bicycle Lane Symbol and Signs

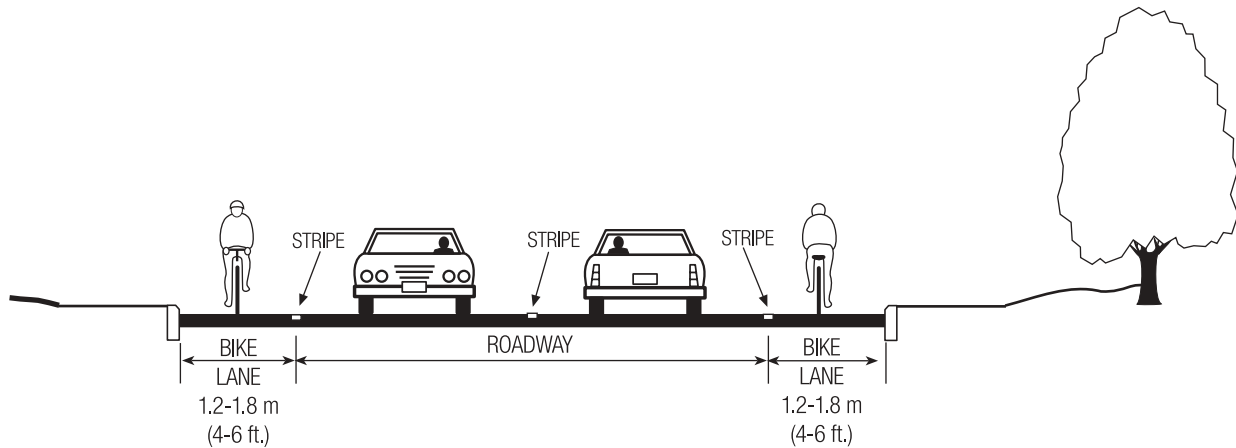

**Figure 4-4.**  
Bicycle Lane, Curbed Street, No Parking.

**Table 4-5.**  
Bicycle Lane, Curbed Street, No Parking

Minimum <sup>(a)(b)</sup>	Conditions
1.2 m (4 ft)	Urban or village curbed street where parking is not permitted and bicycle lanes are provided next to the curb
Preferred <sup>(b)</sup>	Conditions
1.8 m (6 ft)	Where bicycle use is high, where in-line skaters are expected, or along grades over 5 percent.

<sup>(a)</sup> Add 0.3 m (1 ft) on bridges or where there are 30 or more overtaking heavy vehicles per hour in a single outside lane.

<sup>(b)</sup> Width measured from the curb face to the center of the bike lane stripe.

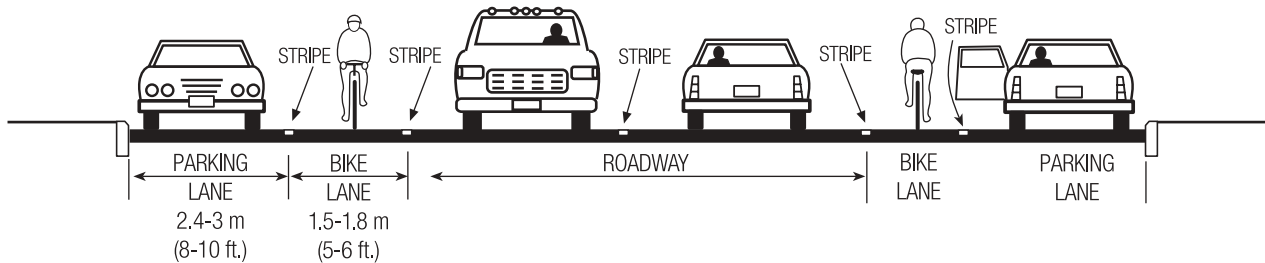

**Figure 4-5.**  
Bicycle Lane, Curbed Street, with Parking.

**Table 4-6.**  
Bicycle Lane, Curbed Street, with Parking

Minimum <sup>(a)(b)</sup>	Conditions
1.5 m (5 ft)	Urban or village curbed street where a delineated parking lane is provided.
Preferred <sup>(b)</sup>	Conditions
1.8 m (6 ft)	Urban or village curbed street where a delineated parking lane is provided, where bicycle use is high, where in-line skaters are expected or along grades over 5 percent.

<sup>(a)</sup> Add 0.3 m (1 ft) on bridges or where there are 30 or more overtaking heavy vehicles per hour in a single outside lane.

<sup>(b)</sup> Width measured from the curb face to the center of the bike lane stripe.

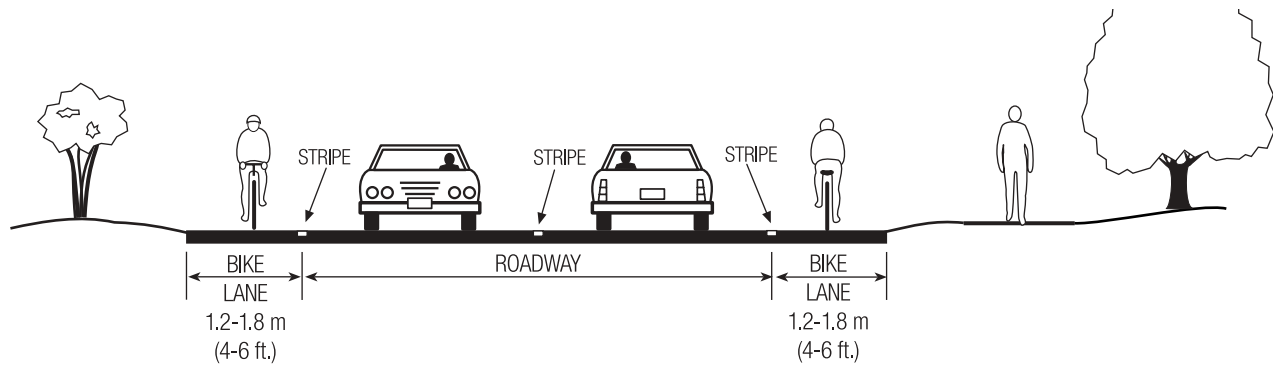

**Figure 4-6.**  
Bicycle Lane, Street or Highway, No Curb, No Parking.

**Table 4-7.**  
Bicycle Lane, Street or Highway, No curb, No Parking

Minimum <sup>(a)</sup>	Conditions
1.2 m (4 ft)	Ideal conditions (i.e., where certain edge conditions do not dictate additional bicycle lane width).
Preferred <sup>(b)</sup>	Conditions
1.5 m (5 ft)	Highways without curbs; vehicle speeds are 56 km/h (35 mph) or less.
1.8 m (6 ft)	Highways without curbs; where vehicle speeds exceed 56 km/h (35 mph).
1.8 m (6 ft)	Where bicycle use is high, where in-line skaters are expected or along grades over 5 percent.

<sup>(a)</sup> Add 0.3 m (1 ft) on bridges or where there are 30 or more overtaking heavy vehicles per hour in a single outside lane.

<sup>(b)</sup> Width measured from the curb face to the center of the bike lane stripe.

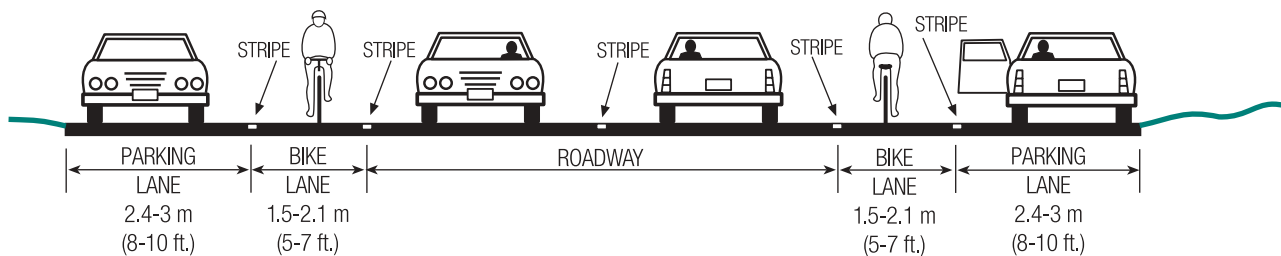

**Figure 4-7.**  
Bicycle Lane, Street or Highway, No Curb, with Parking.

**Table 4-8.**  
Bicycle Lane, Street or Highway, No Curb, with Parking

Minimum <sup>(a)</sup>	Conditions
1.5 m (5 ft)	Ideal conditions (i.e., where certain edge conditions do not dictate additional bicycle lane width).
Preferred <sup>(b)</sup>	Conditions
1.8 m (6 ft)	Highways without curbs; vehicle speeds are 56 km/h (35 mph) or less.
2.1 m (7 ft)	Highways without curbs; where vehicle speeds exceed 56 km/h (35 mph).
2.1 m (7 ft)	Where bicycle use is high, in-line skaters are expected or along grades over 5 percent.

<sup>(a)</sup> Add 0.3 m (1 ft) on bridges or where there are 30 or more overtaking heavy vehicles per hour in a single outside lane.

<sup>(b)</sup> Width measured from the curb face to the center of the bike lane stripe.

### 4.3.3 Practices to Avoid

Avoid the following unsafe designs:

**Left-side bicycle lanes.** Do not locate a bicycle lane on the left side of a one-way street because it creates unexpected conflicts at intersections. A rare exception is when the number of conflicts can be substantially decreased, such as may be created by heavy bus traffic or unusually heavy right-turning movements, angled on-street parking, or where there are a significant number of left-turning bicyclists.

**Two-way bicycle lanes.** Do not use two-way bicycle lanes. A rare exception occurs on the left side of a one-way street when the number of conflicts can be substantially decreased. Refer to Section 4.3.6, Contra-flow Bicycle Lanes.

**Bicycle lanes on one side of a two-way street.** Do not place a bike lane in only one direction of travel on a two-way street. This can lead to wrong-way riding as bicyclists may perceive the facility to be intended for two-way use. If limited road space is available, it may be preferable to have wide outside lanes in both directions rather than one bike lane in one direction. The exception is when there is only adequate space for one bike lane on a street with a severe grade. In that case, placing a single bike lane in the uphill direction addresses the slower operating speed and greater operating space that will be exhibited by uphill bicyclists.

**Bicycle use on bridge sidewalks.** Where bridge sidewalks are wide enough for bicycle use, ramps that provide a lateral transition from the roadway to the sidewalk should be provided, especially where motor vehicle volumes and speeds are high, the bridge is long and the outside lanes or shoulders on the bridge are narrow. Ramps should be a minimum of 2.4 m (8 ft) in length and have flared edges as shown in Figure 4-8.

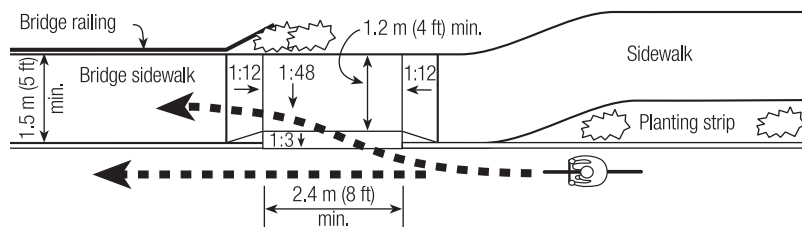

**Figure 4-8.**  
Lateral Transition from Roadway to a Bridge Sidewalk.

Where bicycle use of bridge sidewalks is permitted, the minimum height of a bridge railing along a sidewalk is 1.05 m (42 in). Where extra safety is desired, the preferred height of a bridge railing is 1.35 m (54 in).

**Extruded curbs.** Do not use extruded asphalt curbs or rolled curbs to separate motor vehicles and bicycles for the following reasons:

- Both motor vehicles and bicycles can hit the curb, lose control, and cross into the path of the other user.
- Because asphalt curbs lack structural strength, they are easily broken if hit by motor vehicles or maintenance equipment, which may result in loose pieces of asphalt being scattered over the riding surface.
- At night, extruded curbs may be hard to see because they are usually the same color as the adjacent pavement. They also cast shadows on the lane, further reducing a bicyclist's visibility of the riding surface.
- Extruded curbs are difficult to maintain, are easily damaged by snow plows and trap and collect debris, sand and leaves.

**Reflectors and raised pavement markers.** Do not use raised obstructions, such as reflectors or raised pavement markers to delineate a lane that bicyclists may use. These obstacles can deflect bicycle wheels and cause loss of control and create problems for maintenance workers.

#### 4.3.4 Bicycle Lanes at Intersections

When a bicycle lane meets an intersection:

- Do not extend bicycle lane striping across pedestrian crosswalks.
- Do not extend bicycle lane striping through street intersections.
- Where crosswalks are not provided, stop bicycle lane striping prior to the near-side cross-street out of the path of turning vehicles. Resume striping on the far-side of the cross-street.
- Dotted guidelines may be extended through complex intersections or multi-lane roundabouts.
- At uncontrolled intersections where right-turning traffic volumes are low, solid bicycle lane striping may continue to the near-side of the cross-street.
- At uncontrolled intersections where right-turning traffic volumes are high or where a bus stop is located, use a dotted line with 0.6 m (2 ft) dots and 1.8 m (6 ft) spaces for the length of the bus stop. Resume solid striping at the far-side of the cross-street (refer to Fig. 4-9A).
- Where a bus stop is located on the far-side of an intersection, use a dotted line with 0.6 m (2 ft) dots and 1.8 m (6 ft) spaces for the length of the bus stop, usually 24 m (80 ft) (refer to Fig. 4-9A).

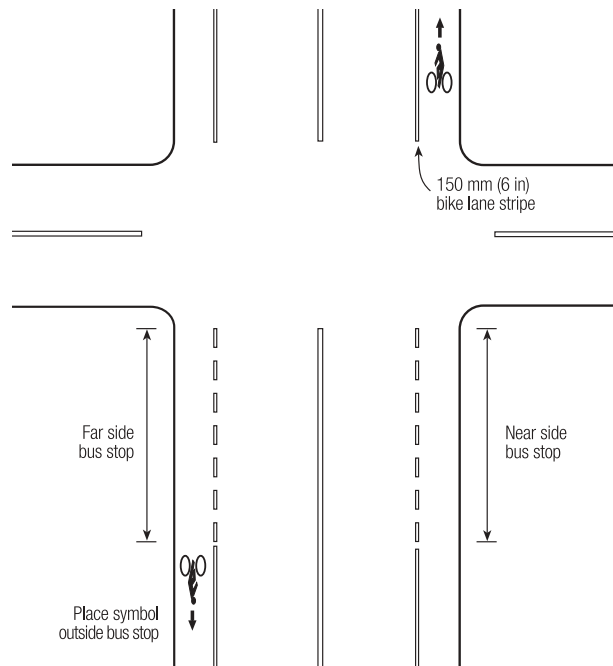

**Figure 4-9A.**

Typical Pavement Markings for Bicycle Lanes on a Two-Way Street with No Crosswalks.

- Where bicycle lanes exist in advance of a roundabout terminate bike lane striping at the pedestrian crosswalk. See Sections 7.2.3 and 7.2.4 for additional design considerations at roundabouts.
- At signalized intersections, consider placing detector loops in the bike lane to allow triggering of the signal (refer to Section 8.3.3 for a detailed discussion of this topic).



- Where a bike lane is located adjacent to on-street parking, the parking lane should be delineated with either a 4 inch (100 mm) white line or white “tick” marks (refer to Fig. 4-9B)

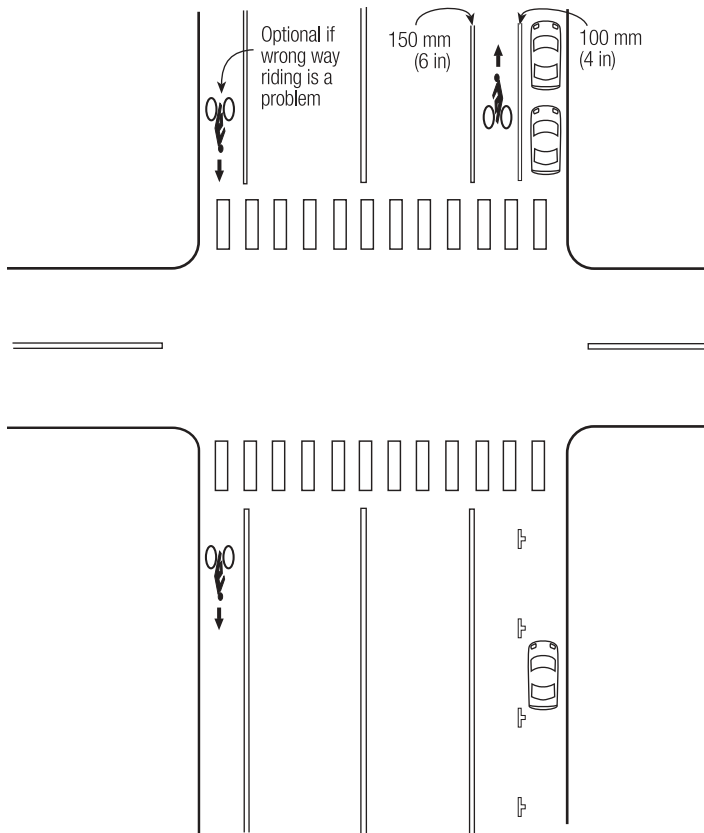

**Figure 4-9B.**

Typical Pavement Markings for Bicycle Lanes on a Two-Way Street with Crosswalks.

- At T-intersections where crosswalks are not provided, the bicycle lane striping on the side across from the T-intersection should continue through the intersection with no break (refer to Fig. 4-10A).

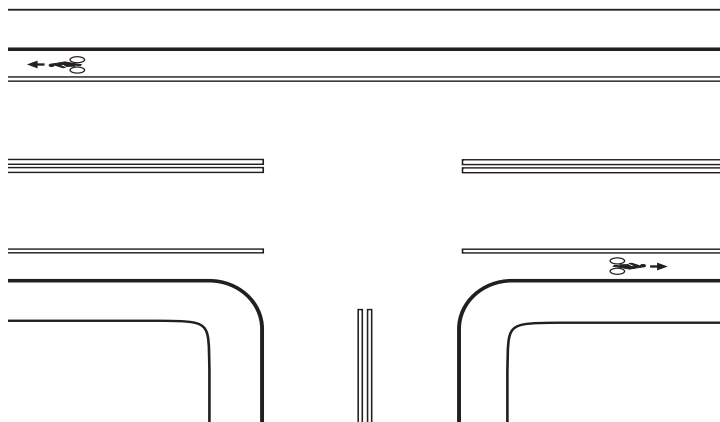

**Figure 4-10A.**

Typical Pavement Markings for Bicycle Lanes at a T-intersection with No Marked Crosswalks.

- At T-intersections where crosswalks are provided, the bicycle lane striping on the side across from the T-intersection should be discontinued only at the crosswalks (refer to Fig. 4-10B).

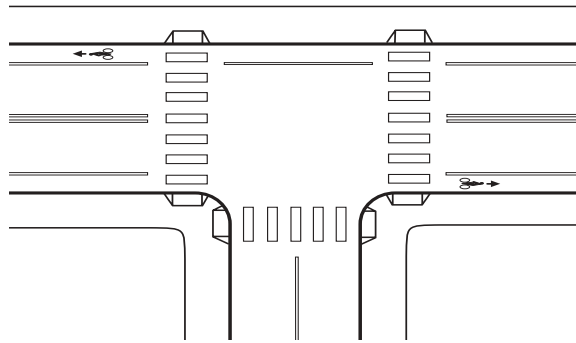

**Figure 4-10B.**

Typical Pavement Markings for Bicycle Lanes at T-Intersections with Marked Crosswalks.

### 4.3.5 Bicycle Lanes and Turning Movements

Conflicts between right-turning motorists and bicyclists proceeding straight through an intersection can be lessened by signing and striping:

- Signing and striping configurations which encourage bicyclists and motorists to cross paths in advance of an intersection, in a merging fashion, are preferred over those that force crossing paths in the immediate vicinity of the intersection.
- At intersections controlled by signals or stop signs and where right-turn lanes exist, use a dotted line with 0.6 m (2 ft) dots and 1.8 m (6 ft) spaces for the approach in lieu of solid striping. The length of the broken line is usually 15 to 60 m (50 to 200 ft).

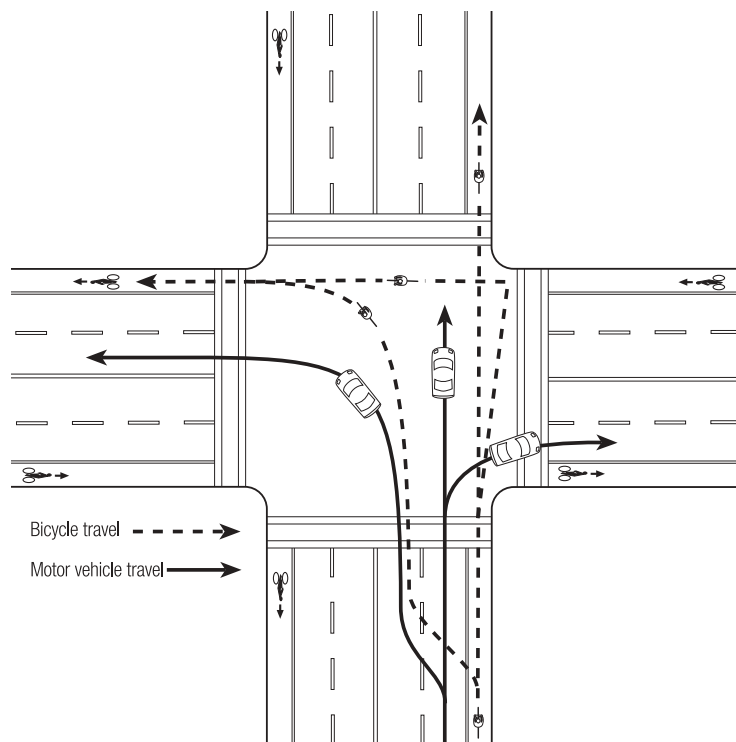

**Figure 4-11.**

Typical Bicycle and Motor Vehicle Movements at Major Intersections.

- Left-turning bicyclists are permitted their choice of a “vehicular” turn (where the bicyclist merges leftward to the same lane used by left-turning motor vehicles, or a “pedestrian style” left turn (where the bicyclist proceeds straight through the intersection, stops at the far side of the intersection, turns left, then proceeds across the intersection again on the cross street). Refer to Fig. 4-11.
- Where there are numerous left-turning bicyclists, consider providing a left-turn bike lane to the right of the left most travel lane.
- Refer to Figure 4-12 A-B for additional pavement marking treatments where a through bicycle lane and right-turn lanes are provided.
- Bike lanes should never be placed to the right of right turn only lanes, as conflicts with motor vehicle traffic will result.
- Where insufficient width exists, place a separate through bicycle lane to the right of the motor vehicle through lane and include signs and pavement markings as shown in Fig. 4-12C.

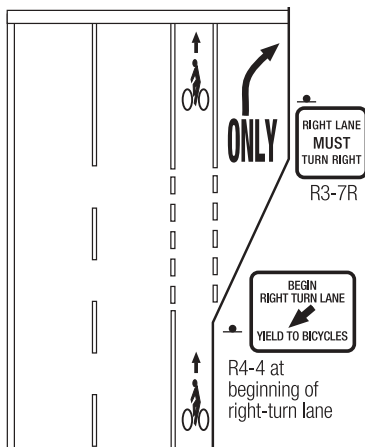

**Figure 4-12A**  
Bicycle Lane with  
Developed Right Turn Lane.

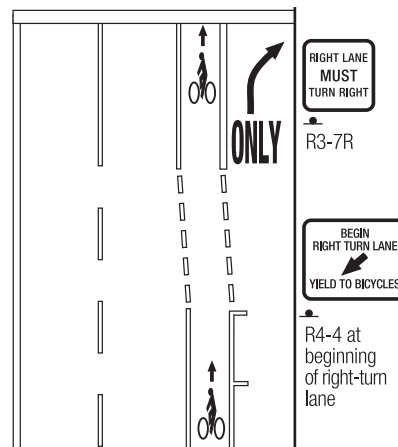

**Figure 4-12B**  
Bicycle Lane and  
Dropped Parking Lane.

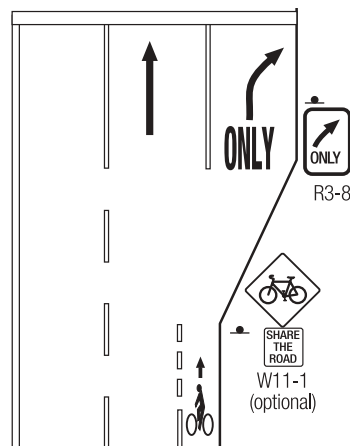

**Figure 4-12C**  
Intersection Widening without Bicycle Lane.

### Section 4.3.6 Interchange Areas

Where on-road bicycle facilities are provided, the area around interchanges can present a greater number of potential conflicts with motor vehicle traffic. This is especially true where on and off ramps diverge and merge with the road on which bike lanes are present. In most cases, the horizontal geometry of the ramps is such that motor vehicles exit or enter at relatively high speeds. The shallow angle of ramps also results in wide throats that present long distances in which motor vehicle and bicyclists are in potential conflict. There are design treatments that can increase the visibility of bicyclists by motorists, reduce the area where conflicts are present, and improve sight lines for bicyclists.

#### On-Ramps

At on-ramps, there are two design options to accommodate bike lanes. The first is to simply carry the bike lane across the throat of the ramp using dotted line and place additional signs in advance of the ramp (see Figure 4-13B). However, this option does not address all the concerns noted above. The second option is to provide an extension of the bike lane on its own alignment that brings it to a point on the ramp where bicyclists can cross at as close to a right angle as possible. Bicyclists then re-enter the bike lane at a point beyond the on-ramp merge area (see Figure 14-C). The location of the ramp crossing should consider the stopping sight distance requirements for vehicles entering the ramp.

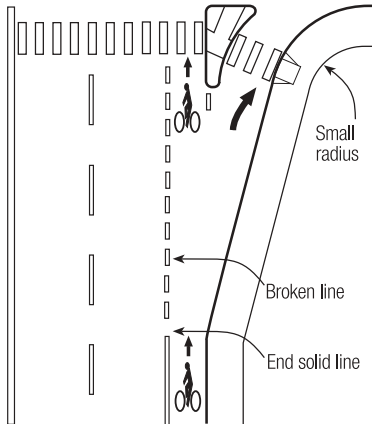

**Figure 4-13A.**  
Dedicated slip lane and small radius curve.

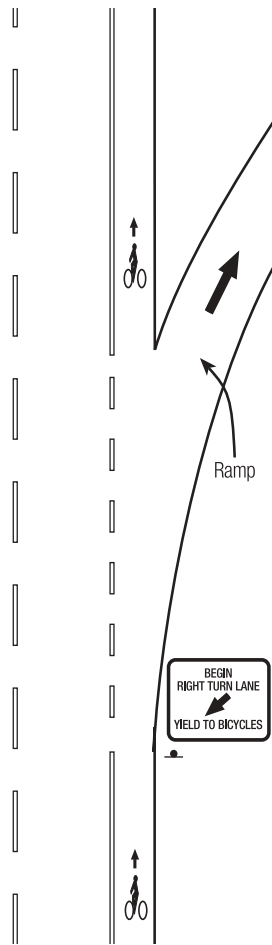

**Figure 4-13B**  
On-ramp with bike lane signs and pavement markings.

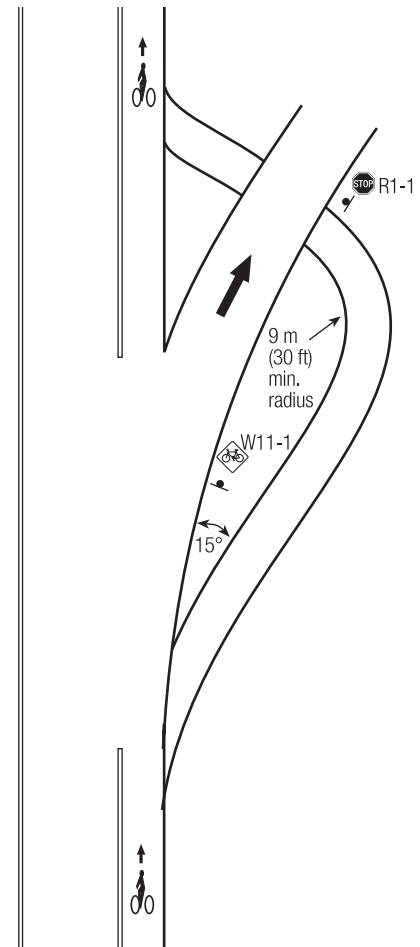

**Figure 4-13C**  
On-ramp with extended bike lane to minimize conflicts.

## Off-ramps

Locations where off-ramps intersect a road with bike lanes pose a different set of problems. If the bike lane continues to the right of the travel lane up to the intersection with the off-ramp, bicyclists end up in the gore area between the travel lane and the ramp. This places them in an awkward position on the roadway. A more favorable design is to curve the bike lane within the gore so that it crosses the ramp at a right angle. Once across the ramp, bicyclists are then in their normal position on the right side of the roadway (see Figure 14-D).

## Special Treatments

To help motorists and bicyclists recognize interchange areas as locations of higher than normal potential conflict; the use of colored bike lanes may be considered. If used, the color should extend for the full width of the bike lane and the 150 mm (6 inch) white line must still be provided. The colored markings should begin in advance of the first on ramp and carried through to the other side of the off ramp. Although the MUTCD does not discuss this treatment specifically, it does provide guidance on the use of different color pavement markings. Colored bike lanes cannot be white, yellow, blue or red. It is recommended that green be used for this application. Because this is considered an experimental pavement marking, a request to experiment must be submitted to FHWA.

High-speed ramps with large radii make crossing and merging maneuvers more difficult for bicyclists. Using a smaller turning radius or a compound curve for ramps and dedicated right-turn slip lanes can lower motor vehicle speeds and improve conditions for both bicyclists and pedestrians. Refer to Figure(s) 4-13A.

### 4.3.7 Contra-Flow Bicycle Lanes

Contra-flow bicycle lanes (one-way bicycle lanes that provide a legitimate way for bicyclists to ride against traffic flow) are not usually recommended because riding against the flow of traffic is contrary to traffic law and a leading cause of bicycle crashes with motor vehicles. However, there are special circumstances in which contra-flow lanes may be considered. These include:

- Where the contra-flow bicycle lane is very short (usually not longer than a city block or two).
- Where provision of a contra-flow bicycle lane provides a substantial savings in out-of-direction travel or direct access to high use destinations.
- Where safety along the contra-flow direction is greater than along the longer or more circuitous route.
- Where there are few or no intersecting driveways, alleys or streets on the contra-flow side of the street.
- Where bicyclists can safely and conveniently reenter the traffic stream at both ends of the section.
- Where a substantial number of bicyclists are already using the street.
- Where there is sufficient room to accommodate a bicycle lane. The preferred width of a contra-flow bicycle lane is 3.0 m (6 ft), but no wider.
- On a one-way residential street recently converted from a two-way street, especially where this change was made to calm traffic.

Additional recommendations for contra-flow lanes:

- Only one-way streets should be considered as candidates for contra-flow bicycle lanes.

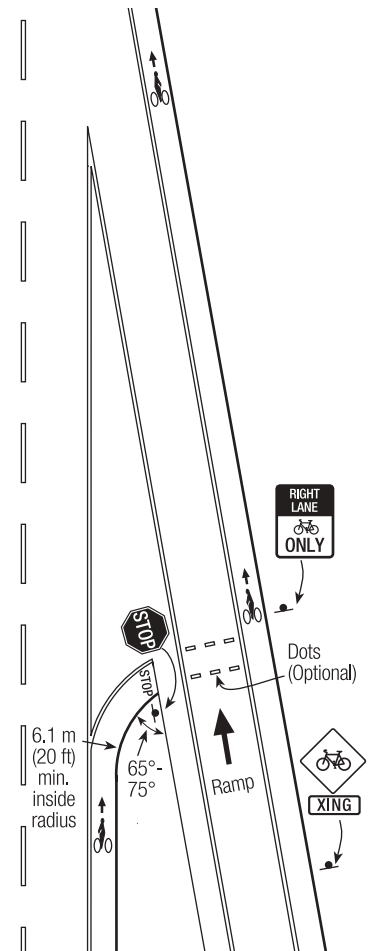

**Figure 4-13D**  
Off-ramp with bike lane signs and pavement markings.

- Under no circumstances should a contra-flow bicycle lane be installed on a two-way street, even where the travel lanes are separated with a raised median. A contra-flow bicycle lane should be located on the left side of the motor vehicle lane(s).
- A contra-flow bicycle lane should be delineated from the motor vehicle lane(s) by a double yellow line consisting of two parallel 150 mm (6 in) solid yellow stripes, which indicates that the bicyclists are riding on the street legally, in a dedicated travel lane.
- Contra-flow bicycle lanes should be one-way bicycle lanes only. Where two-way bicycle travel is desired along a one way street, an additional bicycle lane should be provided to the right of the motor vehicle lane for bicyclists traveling with the flow of traffic.
- Contra-flow bicycle lanes should be no wider than 1.8 m (6 ft) to discourage motorists from using the contra-flow lane for parking or passing.
- Intersecting alleys, major driveways and streets should have signs indicating to motorists they should expect bicycle traffic on each side of the street.
- Existing signals should be fitted with special signals for bicyclists using bicycle sensitive detectors or push-buttons capable of being easily reached by bicyclists without having to dismount.

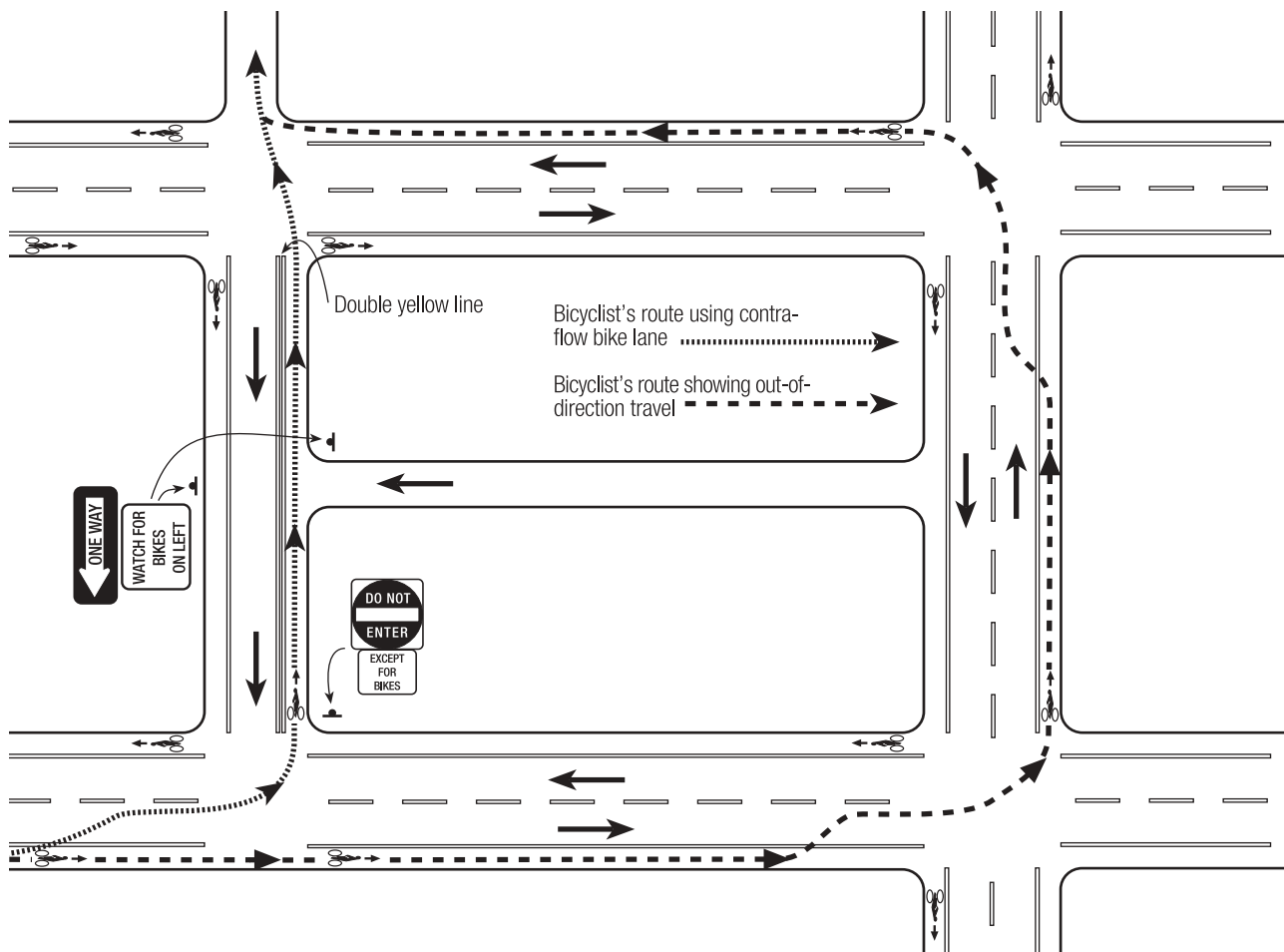

**Figure 4-14.**  
Typical Signs and Pavement Markings for Contra-Flow Bicycle Lanes.

### 4.3.8 Effect of Grades on Bicycle Lanes

Where grades exceed 1:20 (5 percent), it may be desirable to maintain a 1.8 m (6 ft) bicycle lane or paved shoulder as bicyclists need more space to accommodate wobble and maneuvering. This is especially important on uphill grades where bicyclists are moving slowly, have more difficulty maintaining a straight line of travel and the speed differential is usually greatest between motor vehicles and bicyclists.

## 4.4 Wide Curb Lanes

Wide curb lanes are suited for use in village or urban areas where insufficient widths for bike lanes exist. They are distinguished from bike lanes by the absence of signs or pavement markings which specifically designate them for bicycle use. The intent of wide curb lanes is to provide extra space to better accommodate bicycles and motor vehicles in the same lane while providing enough space for motorists to overtake and pass bicyclists without changing travel lanes.

### 4.4.1 Design Considerations

- Wide curb lanes are usually preferred in restrictive settings such as village centers and urban environments where shoulders or bike lanes cannot be provided.
- Where steep grades exist, additional operating width for bicyclists may be required.
- Provide a 100 mm (4 inch) white line or tick marks between wide curb lanes and on-street parking
- Widths greater than 4.2 m (14 ft) that extend continuously along a highway for long distances may encourage the undesirable operation of two motor vehicles side by side in one lane. In such situations, consider striping bicycle lanes or shoulders.

Restriping existing multi-lane facilities may result in enough room to install wide curb lanes where travel lanes and left-turn lanes can be narrowed or the existing number of lanes can be reduced (refer to Section 4.3.9, Reallocating Roadway Space). However, this should only be considered after careful review of traffic characteristics along the corridor and where supported by a documented engineering analysis.

### 4.4.2 Width

Refer to the Vermont State Standards for minimum widths of wide curb lanes. The widths are dependent on roadway classification, design speed and traffic volume and range from 3.6 m to 4.5 m (12 to 15 ft) Consideration should be given to providing additional width when large numbers of trucks are expected (i.e., 30 or more overtaking heavy vehicles per hour in an outside lane) or limited sight distances exist.

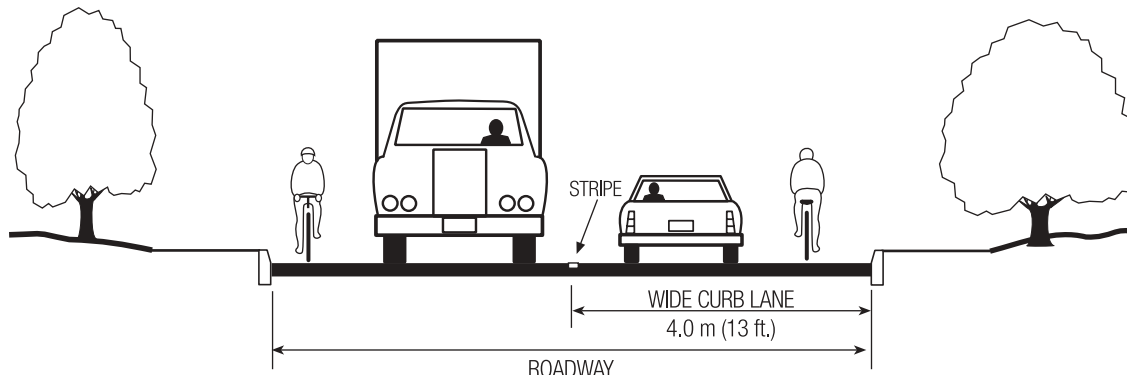

**Figure 4-15.**  
Wide Curb Lane, No Parking.

Island Pond



On uphill grades, a bicycle climbing lane or wide paved shoulder can provide slowly moving bicyclists with extra width to accommodate wobble and maneuvering.

South Burlington



Wide curb lanes are suited for use in village or urban areas where insufficient width for bike lanes exists.

Notwithstanding the minimum widths in the VT State Standards, the preferred width of a wide curb lane where no on-street parking exists is 3.9 m (13 ft) and 4.2 m (14 ft) wide where on-street parking exists.

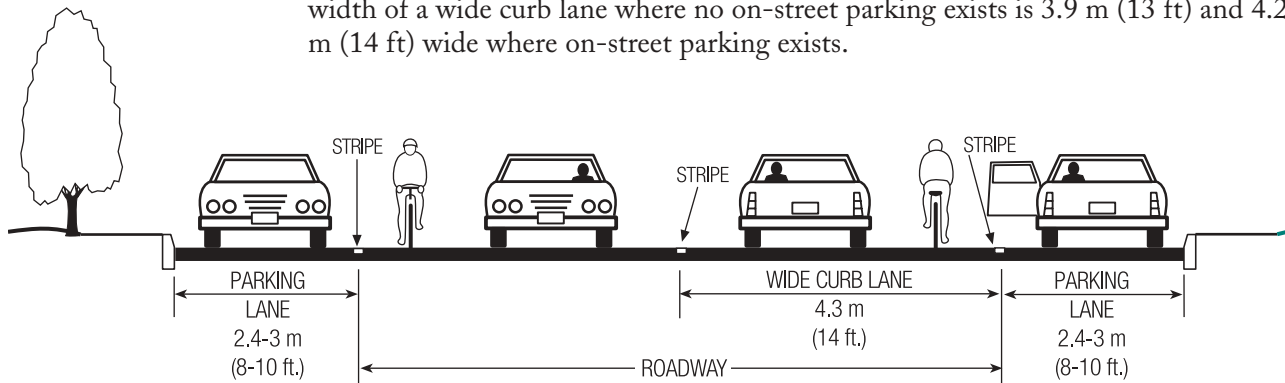

**Figure 4-16.**  
Wide Curb Lane, with Parking.

**Table 4-9.**  
Wide Curb Lanes, Street or Highway, with and without Parking

Minimum <sup>(a)</sup>	Conditions
3.6 m to 4.5 m (12 to 15 ft)	Refer to the Vermont State Standards for minimum widths of wide curb lanes.
Preferred <sup>(a)</sup>	Conditions
3.9 m (13 ft)	Preferred width, no on-street parking.
4.2 m (14 ft)	Preferred width, with on-street parking.

<sup>(a)</sup> Add 0.3 m (1 ft) on bridges, or where there are 30 or more overtaking heavy vehicles per hour in a single outside lane or where limited sight distances exist.

## 4.5 Paved Shoulders

Width is the most critical factor affecting the ability of a roadway to accommodate both bicycles and motor vehicles. Paved shoulders are a type of facility that can provide additional pavement width adjacent to the outside lane of a roadway, thereby improving operating conditions for drivers of motor vehicles, bicyclists and pedestrians, especially in rural areas. Where paved shoulders are provided, the surface condition is critical to safe bicycling.

In Vermont, the majority of bicyclists typically use local roads and rural highways for long distance travel. Notwithstanding the ability of these roads to serve as shared use facilities (refer to Section 4.6), the development and maintenance of paved shoulders defined by an edge stripe can significantly improve the safety, convenience and comfort of bicyclists and motorists.

### Benefits of Shoulders

Paved shoulders have many safety, capacity and maintenance benefits unrelated to bicycling. Most of these benefits also apply to shoulders on rural roads and to marked, on-street bicycle lanes on urban streets.

**Safety.** Highways with paved shoulders have lower accident rates because paved shoulders:

- Reduce passing conflicts between motor vehicles and bicyclists and pedestrians.
- Provide space for disabled vehicles to stop or drive slowly.
- Provide space to make evasive maneuvers.
- Add a recovery area to regain control of a vehicle, as well as lateral clearance to

Lowell



Paved shoulders can significantly improve operating conditions for motorists, bicyclists and pedestrians, especially in rural areas.



roadside objects such as guardrail, signs and poles (highways require a “clear zone,” and paved shoulders give the best recoverable surface).

- Provide increased sight distance for through vehicles and for vehicles entering the roadway.
- Make the crossing pedestrian more visible to motorists.
- Contribute to driving ease and reduced driver strain.
- Provide for storm water discharge farther from the travel lanes, reducing hydroplaning, splash and spray to following vehicles, pedestrians and bicyclists.

**Capacity.** Highways with paved shoulders can carry more traffic because paved shoulders:

- Provide space for bicyclists and pedestrians to travel at their own pace.
- Provide more intersection and safe stopping sight distance.
- Provide space for disabled vehicles, mail delivery and bus stops.
- Allow for easier exiting from travel lanes to side streets and roads (also a safety benefit).
- Provide greater effective turning radius for trucks.
- Provide space for off-tracking of truck’s rear wheels in curved sections.

**Maintenance.** Highways with paved shoulders are easier to maintain because paved shoulders:

- Provide structural support to the pavement.
- Discharge water further from the travel lanes, reducing the undermining of the subbase and subgrade.
- Provide space for maintenance operations and snow storage.
- Provide space for portable maintenance signs.
- Facilitate painting of fog lines.

#### 4.5.1 Design Considerations

- Refer to Vermont State Standards for minimum shoulder widths.
- To be useable by bicyclists, shoulders should be paved with the same surfacing materials as the adjacent roadway travel lane.
- Provide an additional 0.3 m (1 ft) of paved shoulder width where guardrail, bridge railing or other lateral obstructions are present.
- Additional shoulder width should be considered on uphill grades in excess of 1:20 (5 percent) to give slow-moving bicyclists needed maneuvering space, thus decreasing conflicts with faster moving motor vehicle traffic.
- Additional shoulder width should also be considered where downhill grades exceed 1:20 (5 percent) for longer than 1 km (0.6 mi).
- Provide additional width where high volumes of truck traffic are anticipated.
- The use of rumble strips decreases the usability of a shoulder by bicycle traffic (refer to Section 4.7.4, Rumble Strips).
- Delineate paved shoulders from motor vehicle lanes with a 100 mm (4 in) solid white edge line.
- Maintain shoulder widths when adding vehicle passing lanes.
- Provide greater shoulder width where guardrail or other fixed objects are close to the road.

#### 4.5.2 Width

Refer to the Vermont State Standards for minimum widths of paved shoulders to accommodate bicycles. Notwithstanding the minimum values as stated in the Vermont State Standards, as a general rule a paved shoulder width of at least 0.9 m (3

ft) is preferred to accommodate less experienced bicyclists and to provide additional width beyond the travel lane.

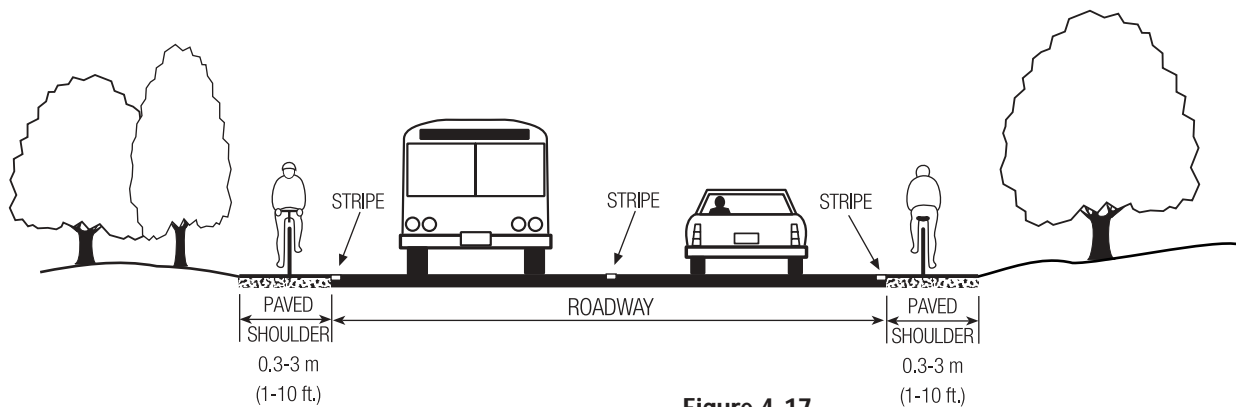

**Figure 4-17.**  
Paved Shoulders.

**Table 4-10.**  
Paved Shoulders.

The following widths are preferred, unless the Vermont State Standards call for a greater width given design conditions.

Preferred <sup>(a)</sup>	Conditions
1.1 m (3 ft)	Average conditions (i.e. where traffic or edge conditions do not dictate additional bicycle lane width).
1.2 m (4 ft)	Preferred shoulder width from the edge of an outside travel lane to the face of a guardrail, curb or other roadside barrier and to fully accommodate the operating width of a bicycle (refer to Figure 4-2).
1.5 m (5 ft)	On highways with steep up-grades where bicyclists require additional maneuvering width or where downgrades exceed 1:20 (5 percent) for a distance of 1 km (0.6 mi) or more.
1.5 m (5 ft)	On highways where there are 30 or more heavy vehicles per hour in the outside lane.

<sup>(a)</sup> Usable width measured from the center of the edge line to the unbroken outside edge of the pavement.

## 4.6 Shared Lanes

To a large extent, most of the bicycling that has taken place in Vermont, and can be expected to take place well into the future, occurs with motor vehicles and bicycles sharing a roadway without the benefit of bicycle lanes, wide curb lanes or paved shoulders. In certain situations — such as along low volume, (AADT < 1,000) residential streets; or lightly traveled roads in scenic, rural locations; or along unpaved roads — it may be unnecessary and even undesirable to provide bike lanes, wide curb lanes or paved shoulders to accommodate bicyclists. In the VTrans report, *Bicycle Touring in Vermont & Vermont's Scenic Byways Program* (1995), bicycle tour operators expressed a concern that “improving” roads that attract touring bicyclists might destroy the “nature” of quiet back roads they intentionally seek for their tours.

Where adding an extra foot or two in roadway width is not an option, features such as bicycle-safe drainage grates and bridge expansion joints, improved railroad crossings, smooth pavement, adequate sight distances, and signal timing and detector systems that respond to bicycles can make roadways more conducive to bicycle travel.

Middlebury



Many of Vermont's low volume streets and lightly traveled local roads adequately accommodate bicycles and motor vehicles in shared lane situations without special provisions for either mode.

### 4.6.1 Design Considerations

- Bicyclists and motor vehicles share same roadway.
- Common on neighborhood streets and rural roads and highways.
- Many existing neighborhood village and downtown streets and local roads can adequately accommodate bicycles and motor vehicles without special provisions for either mode.
- Where conditions such as limited sight distance exist, driver awareness may be increased by the use of standard warning signs.

Shared roadways are most often used by:

- More experienced bicyclists on rural roads. The best conditions exist where traffic volume is very low ( $\leq 500$  ADT), where a low number of critical events (i.e., when an overtaking motor vehicle meets an oncoming motor vehicle in the presence of a bicyclist also using the roadway) are likely to occur, and where good sight distance is available.
- Less experienced bicyclists including children when traveling on low-volume neighborhood streets where fast moving vehicles or through traffic is not a factor.
- All levels of bicyclists on short segments of highway in village and downtown centers with constrained right-of-way, where pedestrians may be expected in higher numbers, traffic speeds are no higher than 40 km/h (25 mph) and short blocks allow bicyclists to share the road despite high traffic volumes.

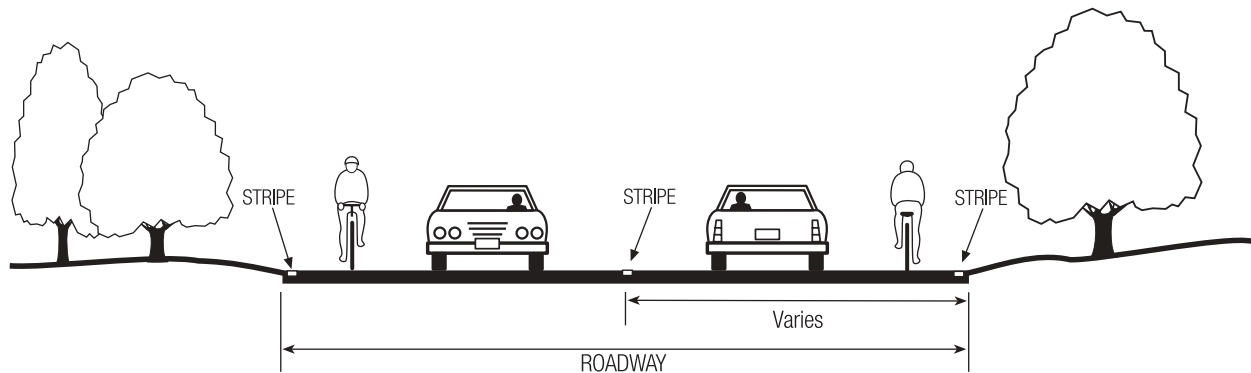

**Figure 4-18.**  
Shared Lanes.

### 4.6.2 Width

Width is the most critical factor affecting the ability of a roadway to accommodate both bicycles and motor vehicles in shared lane situations. Refer to Vermont State Standards for minimum shared lane widths.

In general, 2.8 m (11 ft) is considered to be the minimum width to accommodate experienced bicyclists and motorists in rural areas in low volume situations. Greater widths may be required to accommodate less experienced bicyclists or all bicyclists where higher traffic volumes, traffic speeds, heavy vehicles, or limited sight distances exist.

In village and downtown centers with on-street parking, at least 6 m (20 ft) of combined width for the travel lane and parallel parking stall is desirable. For angled parking, more width is required depending on the angle but generally 9 m (30 ft) is desirable.

Pittsford



Many bicyclists prefer the low traffic volumes, exceptional scenery and variations in terrain offered by Vermont's unpaved roads.

### 4.6.3 - Unpaved Roads

Many bicyclists prefer the riding experience offered by the unpaved roads in Vermont. These roads often have very low volumes and offer exceptional scenery and variations in terrain. There are no specific design considerations related to accommodating bicycling on unpaved roads. Because of the low volumes, no additional width is recommended. In the event that there is a particular hazard along an unpaved road (e.g., sharp curve, narrow bridge), bicyclists will benefit from the warning signs that are posted for all traffic on these roads.

Unpaved roads, like all roads, require regular maintenance. The most important consideration for accommodating bicycling on unpaved roads is the surface condition. This is not an issue particular to bicycling, as all users of the road desire a smooth surface free of irregularities. To maintain a smooth road surface on unpaved roads, proper drainage is critical. This is provided by constructing and maintaining adequate ditches and by adequately grading and compacting the road. For additional information about properly maintaining unpaved roads, refer to the Vermont Better Backroads Manual.

## 4.7 Incremental Improvements

When bike lanes, wide curb lanes or paved shoulders are not feasible, and to improve conditions in shared lane situations, it is often possible to significantly improve the bicycling experience through the implementation of incremental roadway improvements.

From the bicyclist's perspective, as little as 0.6 m (2 ft) of usable riding surface to the right of a roadway edge stripe on major arterial and collector streets and roads can provide an improved operating environment while improving highway capacity.

Next, if it is still not possible to provide any type of bicycle facility using the existing width, evaluate segments for whether:

- Any extra paved space can accommodate incremental improvements.
- The condition of the shoulder can be improved.
- Overly-wide motor vehicle lanes can be narrowed to minimum widths prescribed by the Vermont State Standards.
- The number of motor vehicle lanes can be reduced such as in the case of a roadway that has more than two existing lanes which may be built beyond existing or projected capacity (refer to 4.8, Reallocating Roadway Space).
- Parking can be eliminated.

Implementation of traffic calming (refer to Chapter 7) can also reduce the speed of motor vehicles through physical changes to the vertical or horizontal alignment of the roadway. Speed humps, islands, bulb-outs, and roundabouts are common traffic calming devices.

Other incremental improvements include:

- Bicycle-safe drainage grates (refer to Section 4.9.1).
- Bicycle-friendly railroad crossings (refer to Section 4.9.2).
- Pavement surfaces free of irregularities.
- Bicycle-oriented signs and bicycle-sensitive traffic detection devices (refer to Chapter 8).
- Encouraging through-traffic and large trucks to travel on a few limited corridors.

- Use of limited signing to indicate to motorists that bicyclists are present in significant numbers.
- Slip-resistant durable pavement markings.
- Roadway maintenance including removal of accumulated dirt, broken glass and other debris (refer to Chapter 9).
- Reducing and enforcing posted speed limits.

## 4.8 Reallocating Roadway Space

### Restriping Multi-Lane Roadways

To accommodate bicycle lanes, wide curb lanes or paved shoulders along roadways where widening is impractical, an opportunity may exist to narrow or reduce the number of motor vehicle travel lanes or parking lanes. This may be especially true where roadway capacity exceeds demand. Engineering studies and citizen support should be developed before the number of lanes or parking spaces is reduced. Lane and shoulder widths must meet the minimum dimensions as outlined in the Vermont State Standards.

Where traffic volume, speed or other conditions warrant, **four-lane highways** can be reduced to two-lane designs using raised medians or turning medians. The remaining space can then be used for bicycle lanes or wide curb lanes as space permits. Refer to Figure 4-19A

Where traffic volume, speed or other conditions warrant, **three-lane highways** can be reduced to two-lane designs if the center two way left turn lane is removed or replaced with raised traffic separators. The remaining space can then be used for bicycle lanes or wide curb lanes as space permits. Refer to Figure 4-19B

Westfield, NY



Where traffic volume, speed or other conditions warrant, four-lane highways can be reduced to two-lane designs using raised medians or turning medians.

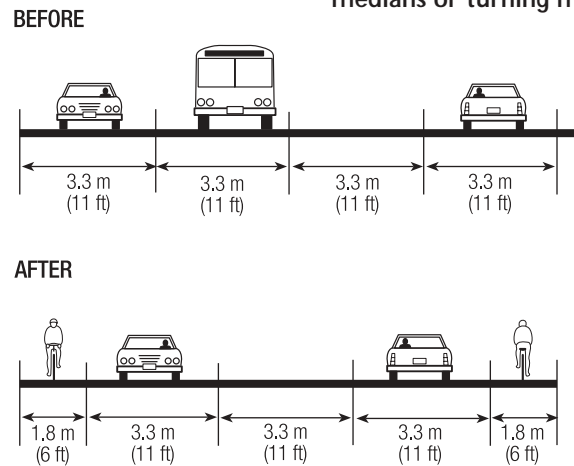

**Figure 4-19A.**  
Going From Two Travel Lanes in Each Direction to One Each Direction with Continuous Two-way Left Turn Lane.

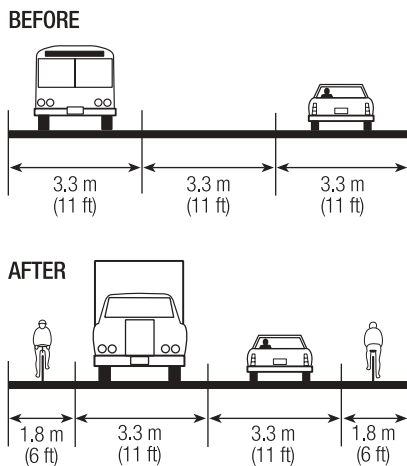

**Figure 4-19C**  
Narrowed Four-Lane Section to Add Bicycle Lanes.

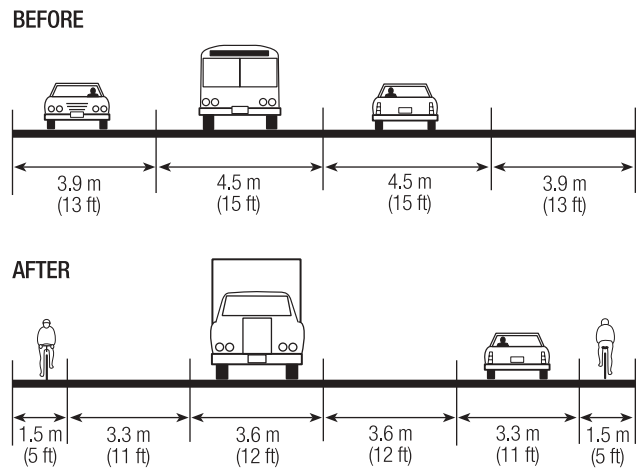

**Figure 4-19B.**  
Going From Two Travel Lanes with Median to No Median.

### Reevaluating Existing On-street Parking

A highway's primary function is to move people and goods. Removing or reconfiguring on-street parking may also provide opportunities for gaining additional roadway space for bicycle lanes or wide curb lanes. However, because adjacent business owners or residents may be affected by such a move, careful research is needed before making recommendations that affect parking.

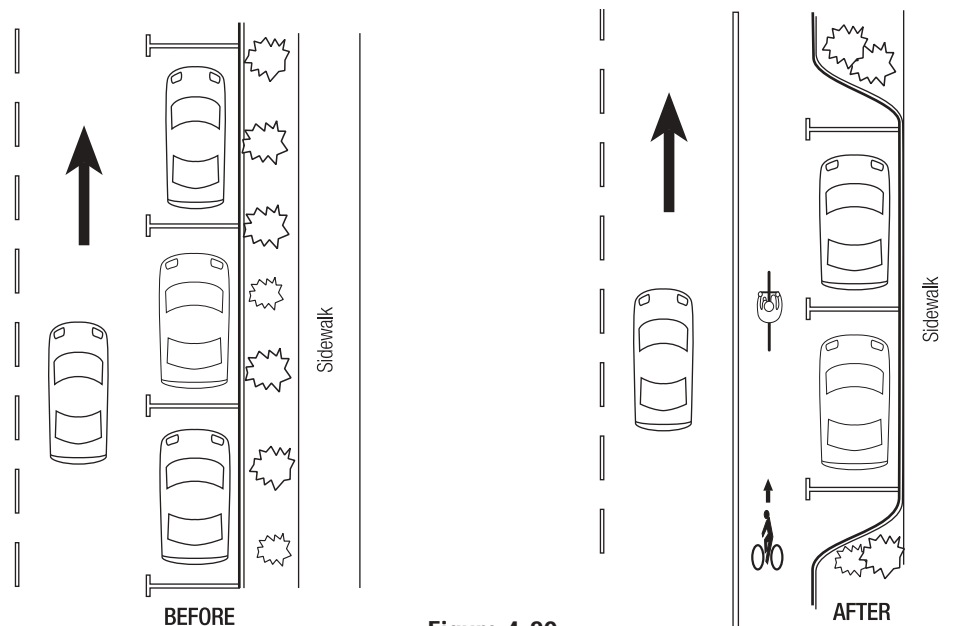

**Figure 4-20.**  
 Reevaluating the Need for Parking.

Alternatives to the elimination of parking spaces include: narrowing the parking lanes, removing parking on only one side of a roadway, or changing from diagonal parking to parallel parking. If a green strip of sufficient width exists, a portion of the strip can be converted to on-street parking to make room for bike lanes.

## 4.9 Other Considerations for On-road Bicycle Facilities

### 4.9.1 Drainage and Drainage Grates

Drainage grates and utility covers can cause problems for bicyclists. Raised or sunken drainage grates or utility covers can stop or divert a bicyclist's front wheel, causing wheel damage or resulting in a crash. A related problem involves old-style parallel bar drainage grates, which can trap the front wheel of a bicycle causing the bicyclist to be pitched over the handlebars.

#### Uneven Grates and Utility Covers

Grates and covers that are not level with the roadway surface should be brought to the proper grade by raising or lowering the device. Newly paved surfaces should be feathered within a maximum of 15 mm (0.5 in) of the cover height to make grates and covers nearly flush with the finished surface of the roadway. Refer to VTrans Standard Drawings D-9M, D-9, D-10M, D-10, D-11M and D-11.

#### Bicycle Safe Drain Grates

Parallel bar drain grates should be replaced with modern bicycle-safe and hydraulically efficient models such as the "vane" or "honeycomb" grates. Where re-



Parallel bar drain grates should be replaced with modern bicycle-safe and hydraulically efficient models such as the "vane" or "honeycomb" grates.

placement cannot be accomplished immediately, square parallel bar drain grates should be realigned so that the bars are perpendicular to the direction of normal bicycle travel.

Numerous bicycle-safe drainage grate designs have been developed that eliminate the dangers of the parallel bar grate, while at the same time maintaining hydraulic efficiency. Refer to VTrans Standard Drawings.

When it is possible to do more than simply replace a grate, curb inlets or offset grates can move the inlet out of the way entirely, thus improving the operating width of the roadway for both bicycles and motor vehicles. Care should be taken to minimize cross slopes, which, if excessive, can throw bicyclists toward the curb. Care should also be taken to provide a wide enough throat on the recessed curb so that it catches water and the effectiveness of snow plowing and/or removal is not compromised. This is a particularly important on steeper grades.

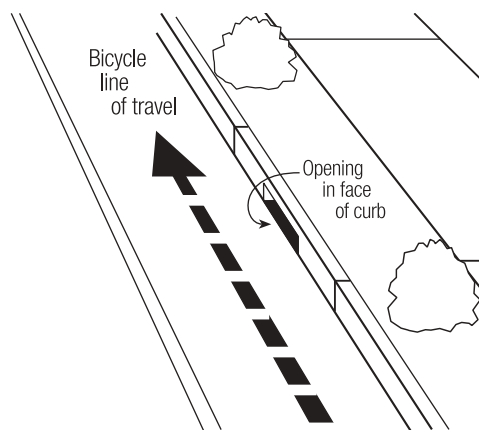

**Figure 4-21.**  
Recessed Drainage Grate.

Parallel bar grates may also be retrofitted with steel straps welded perpendicularly to bicycle travel at 15 cm (6 in) on center to keep bicycle wheels from falling between the parallel bars of the grate. This approach, however, is temporary as motor vehicle traffic can loosen the straps causing an even greater hazard to bicyclists.

#### 4.9.2 Railroad Crossings

Gaps between railroad tracks and the roadway pavement (called the “flangeway”) can divert the front wheel of a bicycle causing the bicyclist to lose control of the bicycle and crash. The problem is most serious when the tracks are at an acute or obtuse angle (less than 45 degrees or more than 135 degrees) to the roadway and the tracks. The more acute or obtuse the angle, the more hazardous a crossing is for bicyclists. Wet weather can exacerbate the problem, making tracks more slippery than in dry weather.

In addition to problems presented by diagonal tracks, uneven surfaces can also cause bicyclists to fall. Rail crossings take a constant and significant beating from both motor vehicle and train traffic. As a result, crossings may be very rough and uneven. Timbers may break up or shift, and asphalt may crumble, mound into large bumps, or develop pot holes and crack.

All public railroad crossing designs should be approved by the VTrans Rail Division and the railroad operator.

To improve a railroad crossing for bicyclists, provide a paved approach and departure for them to cross the rails as near a right angle as possible without veering



**Figure 4-25**  
Sign warning bicyclists of railroad tracks



Rubberized flangeway fillers can smooth railroad track crossings for bicyclists.

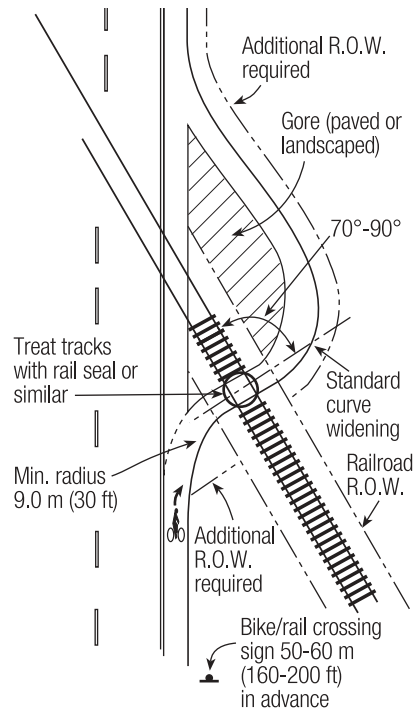

**Figure 4-22.**  
Ridable Railroad Crossing for Acute Angle.

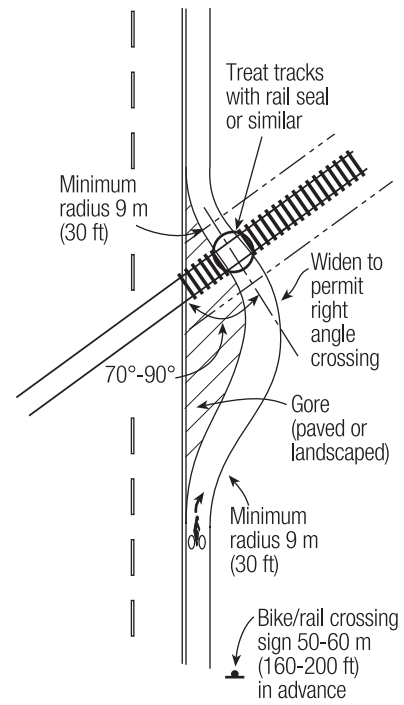

**Figure 4-23.**  
Ridable Railroad Crossing for Obtuse Angle.

To provide a smooth crossing for bicyclists, commercially available rubberized flangeway fillers can be installed adjacent to the inside edge of the track; however, this technique is suitable for low speed rail lines such as might be found in an industrial rail yard or rail car loading zone. Since a train's wheel must compress the flangeway filler, it is essential that the train be moving very slowly, otherwise a derailment could occur.

The best solution is to replace timber and untreated crossings with a concrete crossing. Concrete crossings could decrease long-term maintenance costs while greatly improving bicyclists safety. Refer to VTrans Standard Drawings for details of concrete crossings.

If a crossing is particularly hazardous (less than 45 degrees or greater than 135 degrees) and no physical improvement is possible in the near term, install appropriate warning signs if warranted (refer to Figure 4-25).

### 4.9.3 Bridges and Undercrossings

Because bicycle use for transportation is largely dependent upon convenience and access, any barrier that requires bicyclists to travel long distances out of direction is a serious disincentive. Common barriers include natural features such as rivers, streams and ravines, as well as man-made features such as highways and railroads. In such cases, bridges or underpasses may be the only way to overcome the

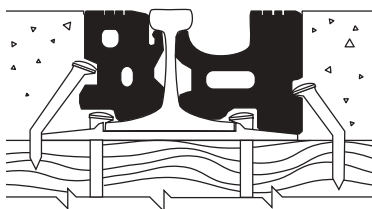

**Figure 4-24.**  
Railroad Flange Filler.



barrier and ensure continuity of the transportation network for bicyclists.

Where on-road accommodation for bicycles has been provided, the approach width of the bicycle facility should be carried across a bridge or through a tunnel. It is recommended that an additional clear space of 0.6 m (2 ft) be provided along the entire length of the bridge or underpass. Where frequent use by inexperienced riders or children is expected it may be appropriate to include a wide sidewalk in the design or provide a supplemental facility physically separated from the roadway facility.

### Surface Conditions

As with all surfaces on which a bicycle will be operated, the surface of a bridge deck should be smooth. There are features common to bridges that can be a hazard to bicyclists. These features include expansion joints, longitudinal gaps, longitudinally grooved pavement, and metal grating (commonly found on draw bridges).

The most critical area for bicyclists is the right-most portion of the bridge in both directions. Where feasible, potentially hazardous surfaces should be discontinued in the area near the right edge of the traveled way for a width of at least 1.2 m (4 ft). Where traffic volumes and speed are high, the width of the smooth surface should be increased.

Other possible treatments include, covering expansion joints with a beveled-edge non-skid steel plate attached to one side, covering longitudinal gaps with a non-skid surface or filling them with a weatherproof sealant.

Metal grate bridge decking can cause a bicyclist to lose control, particularly if the deck is wet or the bicyclist is inexperienced. Filling the voids with lightweight concrete is one solution that can successfully ameliorate the problem. The width of the treatment should be as described above for other hazardous surfaces.

At a minimum, where potentially hazardous conditions exist on bridges, suitable warning signs for bicyclists should be installed on the bridge approaches. It is recommended to use the Bicycle Warning sign (W11-1) with a supplemental plaque advising the type of hazard (refer to Figure 4-26 for an example).

### Covered Bridges

Reduced light levels inside a covered bridge can make it difficult for motorists to see bicyclists and for bicyclists to see gaps between wooden floor boards that could trap the front bicycle wheel causing a crash. Where an even surface cannot be provided or maintained, warning signs may be provided to alert bicyclists of an uneven deck. Where feasible, a separate parallel walkway or bridge can improve conditions for motorists, bicyclists and pedestrians.

Bridges and undercrossings built exclusively for bicyclists and pedestrians are discussed in Chapter 5, Shared Use Paths.

### 4.9.4 Rumble Strips

Rumble strips are used to alert motorists when they begin to traverse from travel lanes onto the shoulder, however, rumble strips can have a serious negative effect on bicycle traffic. Rumble strips placed on highway shoulders decrease the ability of bicyclists to use the shoulder. Rumble strips are a serious safety concern for bicyclists.

Rumble strips take up available paved shoulder width and may force bicyclists to use the travel lane. Bicyclists attempting to initiate a turn, avoid obstructions on the shoulder or traveling downhill at a high rate of speed can lose control of the bicycle

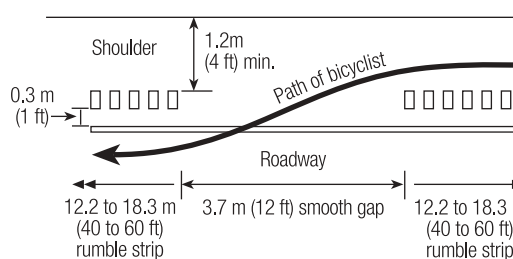

**Figure 4-26.**  
Rumble Strip Warning Sign.

and crash if forced to cross a rumble strip. Current VTrans policy is to use rumble strips only on limited access highways only (where bicyclists cannot legally ride).

In the event that more widespread use of rumble strips in Vermont occurs, the following design should be used to minimize their negative impact on bicyclists:

- Provide a minimum clear path of 0.3 m (1 foot) from the rumble strip to the traveled way.
- Provide 1.2 m (4 feet) clearance from the rumble strip to the outside edge of the paved shoulder, or 1.5 m (5 feet) clearance to an adjacent guardrail, curb or other obstacle.
- Provide a gap pattern that provides periodic portions of smooth pavement allowing bicyclists to enter or leave the travel lane when necessary. Smooth gaps 3.7 m (12 feet) in length should be continuously placed along rumbled sections at intervals of 12.2 m (40 feet) to 18.3 m (60 feet).



**Figure 4-27.**  
**Rumble Strips.**

Provide smooth gaps if rumble strips must be used.

- Do not install rumble strips where existing conditions do not allow the minimum desirable clearance (1.2m [4 ft]) or alternative solutions such as decreasing the width of the rumble strip are not possible.
- Where rumble strips are proposed on roads used by bicyclists, increased maintenance of the shoulder should be undertaken to assure a clear path of travel for bicyclists.

#### 4.9.5 Guard Rails

Guard rail design and placement can affect the safety of bicyclists. Designers should consider the impact of guardrail on shoulder width available for use by bicyclists.

Due to the low height of guard rails, bicyclists may topple over the rail and be injured by guard rail posts and mounting hardware.

Where guard rails are placed along a highway or shoulder, they should be set back a minimum distance of at least 0.8 m (2 ft) from the edge of the roadway or shoulder pavement to maintain a clear shy space for bicyclists (and pedestrians). If this cannot be achieved, the effective usable shoulder width is reduced.

The VTrans 2000 “Study of Guardrail Selection Criteria for Vermont Highways” acknowledges the potential impact of guard rail on bicyclists. Where shoulder width is minimal (less than 3 feet) and traffic volumes are greater than 2000 ADT, the study suggests that guardrail systems with narrower profiles (such as 3-cable or box beam) be used to minimize encroachment on available shoulder width. An additional benefit of these alternative guard rail systems is that they are more aesthetic than standard steel W-beam guardrail.

### 4.9.6 Work Zones and Temporary Traffic Control

Where bicyclists are traveling on a road and a temporary traffic control zone is provided in accordance with the latest version of Part 6 of the MUTCD, they should be expected to traverse the work zone as part of the normal traffic flow. Contractors should consider the needs of bicyclists in establishing and maintaining work zones such that conditions particularly hazardous to bicyclists (e.g. rough surfaces, excessive drop offs, and longitudinal cracks) are avoided. For a more detailed discussion, refer to Section 8.3.4.

## 4.10 *Additional Measures to Improve On-road Bicycling*

There are a number of additional measures that can be taken to improve the on-road bicycling experience. These include:

- Bicycle parking devices (refer to Chapter 9, Landscaping and Amenities).
- Accommodating bicycles on public transportation.
- Keeping existing roadways in good condition (refer to Chapter 10, Maintenance).
- Adding shoulders when repaving.
- Using materials that result in smooth surfaces on unpaved roads.
- Using appropriate signs in high bicycle-traffic areas (refer to Chapter 8, Signs, Pavement Markings and Signals).
- Erecting and maintaining signs that identify the names of intersecting roads at every intersection.
- Using appropriate interstate, U.S. route, state route or local route marker signs in advance of roundabouts to alert all road users where to “exit.”

### 4.10.1 Bicycle Route Maps

Maps designed for bicyclists exist in many forms. In order of increasing complexity, they can:

- Outline short, recreational loop rides.
- Describe the bike route system of a locality (refer to Chapter 2, Planning for Pedestrians and Bicyclists).
- Offer information to bicycle commuters on the most direct routes to various employment centers.
- Define a particular long-distance touring route and provide information about services and attractions along the route.
- Indicate the suitability for shared use of streets and roads by bicycles and motor vehicles throughout a given urban or rural highway system.

The cost of producing, printing and distributing bicycle maps can be much less than the cost of installing and maintaining signs along a route. Defining the function of the map and identifying the primary user group for whom the map is intended will help to determine the type of map which should be produced. Additional discussion of Bicycle Route Maps can be found in Chapter 2, Planning for Pedestrians and Bicyclists..

## 4.11 *Additional Resources*

Consult the following resources for the broadest coverage of issues relating to the planning and design of on-road bicycle facilities:

- *A Policy on Geometric Design of Highways and Streets, Fourth Edition*, 2001 (The Green Book). American Association of State Highway and Transportation Officials (AASHTO), P.O. Box 96716, Washington, DC, 20090-6716, Phone: (888) 227-4860.
- *Bicycle Touring in Vermont and Vermont's Scenic Byways Program*, (1995). VTrans Project and Development Division, Local Transportation Facilities Section, National Life Building, Drawer 33, Montpelier, VT 05633-5001.
- *Flexibility in Highway Design*, 1997. FHWA. HEP 30, 400 Seventh Street SW, Washington, DC 20590.
- *Florida Bicycle Facilities Planning and Design Handbook*, Revised 1999. Florida Department of Transportation, Pedestrian and Bicycle Program, State Safety Office, Mail Stop 82, 605 Suwannee Street, Tallahassee, FL 32399-0450, Phone: (850) 487-1200.
- *Guide for the Development of Bicycle Facilities*, 1999., American Association of State Highway and Transportation Officials (AASHTO), P.O. Box 96716, Washington, DC, 20090-6716, Phone: (888) 227-4860.
- *Highway Capacity Manual, Special Report 209*, 2000. Transportation Research Board, Box 289, Washington, DC 20055, Phone: (202) 334-3214. Next Edition: FHWA Research Program project has identified changes to HCM related to bicycle and pedestrian design.
- *Implementing Bicycle Improvements at the Local Level*, (1998), FHWA, HSR 20, 6300 Georgetown Pike, McLean, VA.
- *Manual on Uniform Traffic Control Devices*, 2000. Federal Highway Administration (FHWA), available from ITE, ATSSA and AASHTO.
- *Oregon Bicycle and Pedestrian Plan*, 1995. Oregon Department of Transportation, Bicycle and Pedestrian Program, Room 210, Transportation Building, Salem, OR 97310, Phone: (503) 986-3555.
- *Pedestrian and Bicycle Crash Types of the Early 1990s* (1996). Published by Federal Highway Administration (FHWA). Available from National Technical Information Service, Springfield, VA 22161, Phone: (703) 487-4650.
- *Selecting Roadway Design Treatments to Accommodate Bicyclists*, 1993. FHWA, R&T Report Center, 9701 Philadelphia Ct, Unit Q; Lanham, MD 20706. (301) 577-1421 (fax only).
- *Study of Guardrail Selection Criteria for Vermont Highways*, (2000). VTrans Project Development Division, National Life Building, Drawer 33, Montpelier, VT 05633-5001.
- *Vermont Better Backroads Manual*, November (1995). Goerge D. Aiken and Northern Vermont Resource Conservation and Development Councils. Available from Vermont Local Roads Program, St. Michaels College and George D. Aiken RCD.
- *Vermont State Standards*. VTrans Project Development Division, National Life Building, Drawer 33, Montpelier, VT 05633-5001.

CHAPTER 5

# Shared Use Paths



## *Contents*

- 5.1 Introduction ..... 5-3
  - 5.1.1 Application ..... 5-3
- 5.2 Planning Considerations ..... 5-3
  - 5.2.1 Characteristics ..... 5-3
  - 5.2.2 Accessibility ..... 5-6
  - 5.2.3 Minimizing Conflicts Between Path Users ..... 5-6
  - 5.2.4 Avoid Placing Shared Use Paths Next to Roadways ..... 5-8
  - 5.2.5 Avoid the Use of Sidewalks for Shared Use Paths ..... 5-10
- 5.3 Design Considerations ..... 5-10
  - 5.3.1 User Requirements ..... 5-11
  - 5.3.2 Widths and Clearances ..... 5-12
  - 5.3.3 Pavement Sections and Surfaces ..... 5-14
  - 5.3.4 Grades ..... 5-17
  - 5.3.5 Cross Slope and Drainage ..... 5-17
  - 5.3.6 Barriers, Bridge Railings and Fencing ..... 5-18
  - 5.3.7 Design Speed, Horizontal Alignment and Stopping Sight Distance ..... 5-21
  - 5.3.8 Roadway and Railroad Crossings ..... 5-22
  - 5.3.9 Managing Motor Vehicle Access ..... 5-28
  - 5.3.10 Structures ..... 5-30
  - 5.3.11 Supplemental Facilities and Amenities ..... 5-32
- 5.4 Construction Zones and Temporary Access ..... 5-33
- 5.5 Additional Resources ..... 5-33

## *Figures*

- 5-1 Paved Shared Use Path With Separate Soft Surface Trail ..... 5-7
- 5-2 Potential Conflict Points ..... 5-8
- 5-3 Shared Use Path, Separation from Roadway in Uncurbed Section ..... 5-9
- 5-4 Shared Use Path, Separation from Roadway in Curbed Section ..... 5-10
- 5-5 Shared Use Paths Accommodate a Variety of Users ..... 5-11
- 5-6 Shared Use Path, Typical Widths and Clearances ..... 5-12
- 5-7 Sub base, Asphalt Pavement ..... 5-15
- 5-8 Bridge Railings ..... 5-20
- 5-9 Plan View of Shared Use Path Striping ..... 5-22
- 5-10 Diagonal Mid-block Roadway Crossing ..... 5-25
- 5-11A Parallel Path Roadway Crossing Using Existing Crosswalk ..... 5-25
- 5-11B Parallel Path Roadway Crossing. Provide Separation Between Path Crossing and Intersection ..... 5-26
- 5-12 Complex Intersection Crossing ..... 5-27

***Shared Use Paths***

5-13	Roadway Crossing with Median .....	5-28
5-14	Splitter Island .....	5-28
5-15	Bollards .....	5-29
5-16	Bridge Decking and Approaches .....	5-31
5-17	Shared Use Path Underpass .....	5-32

***Tables***

5-1	Path Widths of Shared Use Paths .....	5-13
5-2	Recovery Area Widths .....	5-13
5-3	Suitability of Surface Materials for Shared Use Paths .....	5-16
5-4	Desirable Minimum Radii for Paved Shared Use Paths Based on 15 Degree Lean Angle .....	5-22



## 5.1 Introduction

Off-road corridors shared by pedestrians, bicyclists and other non-motorized users are referred to as *shared use paths*. Formerly shared use paths were called “multi-use paths” or “bike paths” This manual uses the following definitions:

*Path* (or *pathway*) – an unpaved walkway sidewalk, or shared use path (whether paved or unpaved).

*Sidewalk* – a paved portion of a street between the curb lines or the lateral lines of a roadway, and the adjacent property lines, intended for use by pedestrians (refer to Chapter 3, Pedestrian Facilities).

*Shared use path* – a facility for pedestrians, bicyclists and other users that is physically separated from motorized vehicular traffic by open space or barrier and either within the highway right-of-way or within an independent right-of-way. Shared use paths are typically used by more than one type of user, such as pedestrians, joggers, people in wheelchairs, skaters, bicyclists, cross-country skiers, and where permitted equestrians and snowmobiles.

The tremendous variety in paths and their users makes uniform standards elusive. Guidelines written to accommodate a specific type of user may not meet the needs of another user. In practice, most trails serve several user types and are, therefore, shared-use paths. Consider the needs of all potential user groups when planning and designing a shared use path.

### 5.1.1 Application

Well-planned and designed shared use paths can provide excellent access and mobility when they complement a network of sidewalks and on-road bicycle facilities. They make connections, can go where roads do not and present a pleasant environment away from traffic including:

- Shortcuts between residential neighborhoods (i.e., between cul-de-sacs and dead-end streets), parks, schools, and business areas.
- Access to areas served only by controlled-access highways where pedestrians and bicycles are prohibited.
- Access to areas not well served by roads such as streams, lakes, rivers, greenways, abandoned or active railroad and utility rights of way, college campuses, and planned unit developments and community trail systems.
- A training ground for child and adult bicyclists.
- An attractive alternative to the street for less experienced bicyclists.

## 5.2 Planning Considerations

### 5.2.1 Characteristics

Successful shared use paths share many of these characteristics:

- Continuous separation from motor vehicle traffic.
- Frequent access points.
- Increased levels of safety and security.

Burlington – Burlington Bike Path



Stowe – Stowe Recreation Path



Stowe – Stowe Recreation Path



Every path is a unique blend of place and the people who use it.

- Scenic qualities.
  - Connectivity to a variety of land uses.
  - Well-designed street and driveway crossings.
  - Potential for shorter trips.
  - High levels of activity.
  - Uniform design and good engineering.
  - Informative signing and marking.
  - Context sensitive design and aesthetics.
  - Regular inspection and maintenance.
  - Potential for making an economic contribution to the community.
1. **Continuous separation from motor vehicle traffic.** Physical separation from motor vehicle traffic is the hallmark of a shared use path. The separation allows path users to avoid the congestion, pollution, noise and intimidation they may perceive from motor vehicles, and reduce the potential for some types of crashes if properly located and designed. Continuous separation from traffic is essential to minimize conflicts with motor vehicles at street and driveway crossings. For this reason, shared use paths are frequently located along riverbanks, greenbelts, railroads, and utility rights-of-way because of the low incidence of conflicts that occur along such corridors. They can also be located in highway corridors.
  2. **Frequent access points.** Balance the need for limited crossings with adequate access. If a shared use path is to serve pedestrians and bicyclists well, there should be convenient access to the local street network. Access points that are spaced too far apart will require users to travel out-of-direction to enter or use the path. Terminate paths where they are easily accessible to the street system such as at controlled intersections or at the end of a cul-de-sac or dead-end street. Frequent access also improves response time of emergency vehicles to incidents on the path.
  3. **Increased levels of safety and security.** Keep the personal safety and security of intended users in mind. Illumination and clear sight distances improve visibility. Frequent access encourages use and reduces isolation. Refer to Section 5.2.13 for a discussion of how design features can affect security.
  4. **Scenic qualities.** Because shared use paths are located away from traffic, often in natural settings, they offer an aesthetic experience that attracts pedestrians and bicyclists. Many communities consider paths as “linear parks” that help define neighborhoods and enhance livability.

Because shared use paths are located away from traffic, often in natural settings, they offer an aesthetic experience that attracts bicyclists and pedestrians.

Burlington



5. **Connectivity to a variety of land uses.** Paths should not be isolated facilities. They should link shopping areas, parks, schools, employment centers and other community facilities with residential neighborhoods.
6. **Well-designed street and driveway crossings.** While shared use paths provide segregation from motor vehicle traffic along most of their length, they inevitably intersect with roadways and driveways and thus conflict with motorized traffic. Good design is especially important at path junctions with roadways and driveways to enhance operations, and to minimize



conflicts and potential crashes. Refer to Section 5.3.8 for a discussion of crossings.

7. **Potential for shorter trips.** Shared use paths may offer shorter trip lengths than the road network by making connections between dead-end streets and cul-de-sacs, or as shortcuts through undeveloped areas or open spaces, or as a bypass around signalized intersections.
8. **High levels of activity.** Activity created by locating pedestrian and bicycle facilities in close proximity to housing and businesses has been shown to increase safety of all concerned. Despite fears of some property owners, paths have not attracted crime into adjacent neighborhoods. To the contrary, proximity to shared use paths is frequently touted by real estate developers and salespeople as an attractive benefit to potential homeowners and a sales plus.
9. **Uniform design and good engineering.** Paths that attract different types of users should be built to a standard that accommodates various uses with minimal conflict. Designing a facility to a low standard can save money initially but can lead to problems when a facility becomes popular. Successful shared use paths exhibit uniform design and good engineering. While there are similarities between the design criteria for shared use paths and highways (e.g. horizontal alignment, sight distance requirements, signing and markings), other criteria (e.g., horizontal and vertical clearance requirements, grades and pavement structure) are dictated by the characteristics of the various path users and are substantially different from those of motor vehicles. Be aware of the similarities and differences between different path users and motor vehicles and of how these similarities and differences influence the design of shared use paths.
11. **Informative signing and marking.** Because shared use paths often stray from familiar landmarks, good signing may be required to orient, inform and direct path users along a path. Other signs should direct users to and from a path at junctions with the street system.
12. **Context sensitive design and aesthetics.** Path design should be sensitive to the natural surroundings in which they are located. Preserve and complement natural features to the maximum extent possible, and design path features and amenities to reflect the human scale of the user.

Attempt to make a facility as “continuously interesting” as possible by creating variety in the shared use path:

- A path that follows natural terrain is more interesting than one that is straight.
  - Clumps of trees arranged naturally are more interesting than trees placed in a straight line.
  - Color can be added through different types of vegetation.
  - Water features are always interesting.
  - Periodic views and openings that reveal a middleground and background are more interesting than views that contain the foreground only.
  - Leeways or variations in the width of a path can also create interest while providing a place for people to rest or wait for friends.
  - Curved lines are more appealing than straight lines in natural areas.
  - Artificially created berms or mounds can add vertical interest.
13. **Regular inspections and maintenance.** Regular sweeping and repair is essential. Separation from motor vehicle traffic can reduce some maintenance problems, such as sweeping away debris that accumulates on roadways. Leaves will

need sweeping, vegetation will need to be cut back, and surface and subsurface repairs will be needed. Refer to Chapter 10, Maintenance.

#### **14. Potential for making an economic contribution to the community.**

Shared use paths can make a significant contribution to local economies by attracting vacationing bicyclists and pedestrians to communities that provide places for bicycling and walking safely removed from busy roads and streets. Investments in shared use paths and rail-trails can also increase adjacent property values and improve the overall livability of a community.

### **5.2.2 Accessibility**

Shared use paths should be designed to meet the needs of the widest possible range of users, including people with disabilities. This means that they provide a continuous, unobstructed path of travel for the disabled.

If the ability to comply with the requirements of the ADA is in question, designers should check with the U.S. Architectural and Transportation Compliance Board (Access Board).

Accessibility of a path depends not only on the design of the path itself but also upon the accessibility and availability of facilities and features associated with a shared use path, including:

- Parking areas.
- Path entrances.
- Path destinations.
- Scenic viewpoints.
- Interpretive displays.
- Facilities such as rest areas, restrooms, shelters, drinking fountains etc.

Plan path facilities and features to correspond with the on-path conditions, user needs and expectations, and the desired path experience.

Until recently, guidance for providing trail accessibility was derived from the American with Disabilities Act Accessibility Guidelines (ADAAG). However, direct application of the ADAAG provisions for accessible routes of travel has been found to be inappropriate for many shared use paths. For a greater level of detail on how to make sidewalks, street crossings, paths and trails more usable for all pedestrians, consult *Designing Sidewalks and Trails for Access, Part II: Best Practice Design Guide* (FHWA, 2001). This guide provides design details and alternative treatments for making sidewalks and shared use paths accessible to all users.

### **5.2.3 Minimizing Conflicts Between Path Users**

During the design phase of a project it is important to identify the intended users of the project and the various needs they may have. Accommodating these needs can have a significant impact on design features of the project. For example, surface type is a major determinant of who will use the project (i.e., unpaved surfaces will discourage in-line skating and roller skiing while at the same time encourage equestrian or snowmobile uses). It should also be noted that permitted uses on a project may be dictated by the funding source used to develop a project.

The safety and enjoyment of a shared use path can decline when conflicts among users occur. Conflicts stem from many sources:

- Personal expectations.
- Overcrowding.
- Clashes between different path user skill levels and speeds.

- Attitudes toward other types of users.
- Dominance by one user group.
- Intrinsic differences in movement patterns.

Although these issues are complex, good planning and design can greatly decrease conflicts. Some techniques for minimizing conflicts between path users include:

- Limiting path use by regulation and enforcement.
- Limiting path use by design.
- Accommodating different types of users through design.
- Accommodating different types of users through path courtesy and education.

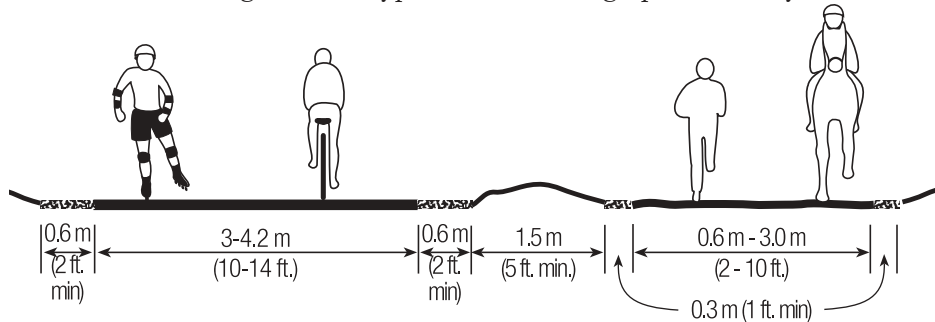

**Figure 5-1.**

Paved Shared Use Path With Separate Soft Surface Trail.

**Limiting path use by regulation and enforcement.** One way to limit certain types of path use is through regulation. The unofficial use of paths by motor vehicles (including power assisted bicycles, mopeds, ATVs, motorcycles, farm tractors, cars and trucks) should be prohibited and strictly enforced. The use of motorized wheelchairs, snowmobiles, emergency vehicles and maintenance vehicles should be permitted as appropriate. As is the case with all regulation, enforcement is needed to make sure that actual use occurs in accordance with rules and ordinances that apply to the intended use.

**Limiting path use by design.** Although pedestrians, bicyclists, equestrians, and other users get along on many shared use paths, the potential for conflict is high. Where it is desired that path use be limited to pedestrians and bicyclists only, gates, stiles and fences can effectively limit vehicles from accessing the path. (Refer also to Section 5.3.8, Managing Motor Vehicle Access).

Where it is desired to discourage certain types of users such as in-line skaters, roller skaters, and skate boarders the use of unpaved surface materials that are incompatible with these uses should be considered.

**Accommodating different types of users through design.** The preferred approach is to accommodate different non-motorized user types through design. For a shared use path to accommodate a large variety and number of users, it needs to be as wide as necessary, preferably with a broad firm surface and clear shoulders on each side of the path. It may be advisable to separate users by designating lanes in the path or by creating parallel and separate paths (such as an unpaved bridle path for equestrians or a jogging path for runners). Features that can help to improve the safety and convenience of shared use paths are discussed in Section 5.3, Design.

**Accommodating different types of users through path courtesy and education.** Conflict between users can also be managed by promoting courtesy along the path.

South Burlington



A paved shared use path with a separate soft surface trail for joggers and equestrians can minimize conflicts between path users.

Safety and etiquette are responsibilities shared by everyone. A path etiquette educational campaign can help develop a positive ethic among users. Common educational tools include:

- *Signs.* Safety signs are one of the simplest and most effective ways to promote courtesy because they convey important information quickly. Where conflicts arise post a uniform system of operating and advisory signs at regular intervals along a shared use path. Present one message per sign and keep the message simple so children and adults can understand it. Repeat basic safety and operating rules such as “Bicyclists use bell or voice when passing,” “All users keep right,” and “Bicyclists yield to pedestrians.”
- *Printed materials.* Brochures, pamphlets and newsletters displayed along the path, at trailheads and at information stations can help educate trail users and cultivate a positive user ethic.
- *Special Events.* Safety days and other special events are an enjoyable way to promote safety and etiquette.
- *Presentations.* Presentations at recreation clubs, schools, and civic organizations not only help educate people about path courtesy but offer opportunities to promote the shared use path as well.

### 5.2.4 Avoid Placing Shared Use Paths Next to Roadways

Shared use paths are not a substitute for street improvements even if there is sufficient space to locate a path adjacent to the roadway. Experienced bicyclists often find it less convenient to ride such paths compared with the streets, particularly for utilitarian trips where speed and access are high priorities. **Some operational problems with paths adjacent to roads are:**

- Some bicyclists will be riding against the normal flow of traffic contrary to the rules of the road.
- When the path ends, bicyclists riding against traffic may continue riding on the wrong side of the street. Wrong-way travel by bicyclists is a major cause of bicycle/motor vehicle crashes.
- At intersections, motorists entering or crossing the roadway often do not notice bicyclists approaching from their right, as they are not expecting any traffic from that direction. Motorists turning to exit the roadway may likewise fail to notice bicyclists. Refer to Figure 5-2.

South Burlington



Shared use paths should not be located immediately adjacent to roadways as this requires at least half the bicyclists using the facility to ride against traffic. Instead, locate paths away from the roadway as seen in the distance.

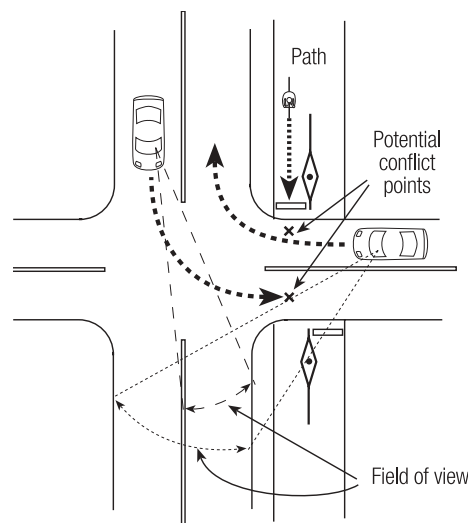

Figure 5-2.  
Potential Conflict Points.

- Barriers used to separate motor vehicle traffic and bicycle and pedestrian traffic can obstruct motorists, bicyclists and pedestrians vision alike, reduce access along the street and path, and complicate maintenance of both facilities.
- Snow plowed from an adjacent roadway can obstruct path use if the path is not simultaneously plowed along with the street.

Where the following conditions exist it may be appropriate to provide a shared use path within or adjacent to a highway right-of-way used by motor vehicles:

### 1. Location and Need

- No reasonable alternative alignment exists for bicycle and pedestrian facilities on nearby parallel routes or on an independent alignment.
- The adjacent roadway is a heavily traveled, high-speed, high volume roadway where on-road bicycle facilities may contribute to unsafe conditions for the design bicyclist.
- Bike lanes, wide curb lanes, paved shoulders, or sidewalks are not a feasible alternative.
- Increased levels of pedestrian activity and bicycle usage along the corridor are anticipated.
- The majority of origins and destinations are on one side of the road.
- There is a commitment to provide a continuous non-motorized system throughout the corridor.
- The total cost of providing the proposed path is proportionate to the need.
- The expected users (design bicyclist) for the project are inexperienced bicyclists (Group C) or pedestrians. Refer to Chapter 4, section 4.2.1 for a complete discussion of design bicyclists.

### 2. Separation and Conflicts

For shared use paths in highway corridors, consider the following guidelines:

- A minimum horizontal separation of 1.2 m (4 ft) for curbed and 1.5 m (5 ft) for uncurbed sections or an appropriate barrier between the edge the shoulder (whether paved or unpaved) and the shared use path is provided. Refer to Section 5.3, Design.
- Landscaping or natural vegetation buffer the path from noise and splash of motor vehicles. Alternately, a drainage ditch or swale with maximum side slopes of 1:3 can be provided at the edge of a 0.6 m (2 ft) shoulder.
- The path can be terminated on streets where bicycle and pedestrian facilities are provided.
- Potential driveway and intersection conflicts are minimized or mitigated.
- The path has sufficient width, to accommodate the expected users.

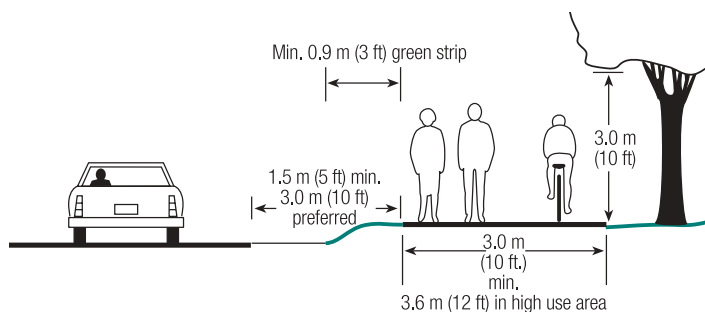

**Figure 5-3.**  
Shared Use Path, Separation from Roadway in Uncurbed Section.

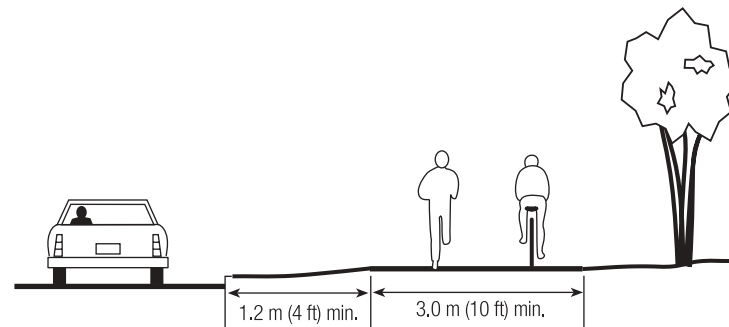

**Figure 5-4.**  
Shared Use Path, Separation from Roadway in Curbed Section.

### 3. Access

If a shared use path is located in a highway corridor, consider the following factors to decide on which side of the road it should be placed:

- Access to all destinations served by the adjacent roadway is available and convenient for path users.
- There is adequate access to local cross-streets and other facilities along the route.
- Any needed grade-separation structures do not add substantial out-of-direction travel for path users.
- Popular origins and destinations (such as neighborhoods, schools and parks) exist or are planned throughout the corridor.

#### 5.2.5 Avoid the Use of Sidewalks for Shared Use Paths

Sidewalks are pedestrian facilities designed for pedestrian speeds and maneuverability. They should not be used as shared use paths unless they conform to the minimum dimensional characteristics of paths because:

- Sidewalks rarely have adequate clear space for multiple users. The potential for conflicts between pedestrians traveling at low speeds and bicyclists traveling at higher speeds are high.
- Pedestrians often cross sidewalks to reach adjacent buildings or parked cars and do not expect bicyclists to cross their path.
- Poles, benches, trees, and other obstacles are often located in the sidewalk area further restricting the available width of the sidewalk.
- At intersections, motorists will not expect bicyclists (who may be traveling at higher speeds than pedestrians) to enter the crosswalk area. Sight distance may be impaired by buildings, walls, property fences and shrubs along sidewalks, especially at driveways, which is more problematic for higher speed bicyclists.

Consider sidewalk bikeways only for limited durations along short sections of sidewalk where no other bicycle facility alternative exists or unless the sidewalk width conforms to the minimum dimensional characteristics for a shared use path.

## 5.3 Design Considerations

The key design guidelines for shared use paths include:

- User requirements.
- Widths and clearances.

- Pavement sections and surfaces.
- Cross slope and drainage.
- Grades.
- Side slopes, fencing and barriers.
- Design speed, horizontal alignment and stopping sight distance.
- Roadway crossings.
- Managing Motor Vehicle Access.
- Structures.
- Signing and marking.
- Supplemental facilities.
- Security. (Refer to Chapter 9)
- Lighting. (Refer to Chapter 9)
- Maintenance (refer to Chapter 10).
- Vegetation and Landscaping (refer to Chapter 9).

### 5.3.1 User Requirements

Shared use paths attract people of all ages, with capabilities ranging from slow-moving pedestrians to fast-moving bicyclists. Added to the mix may be in-line skaters, skateboarders, scooters, joggers, baby carriages, dogs, and even horses. Each type of path user has its own set of user requirements. Refer to Chapter 4, On-road Facilities for dimensional requirements and diagrams. For details regarding user requirements and accommodating equestrian, snowmobile, snowshoe or cross country users refer to Chapter 6, Rail Trails.

#### Pedestrians

The design of paths and the surrounding environment is important to all pedestrians, but it is particularly important to people with disabilities. Shared use paths should seek to minimize the constraints within the natural environment and avoid creating new constraints. The use of standard accessibility standards for sidewalks and crossings plus the guidelines in this manual should satisfy the needs of most pedestrians.

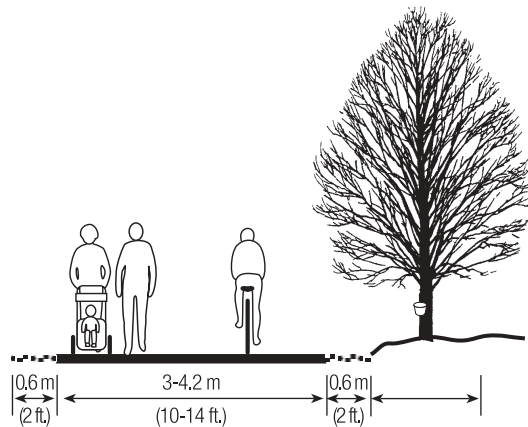

**Figure 5-5.**  
Shared Use Paths Accommodate a Variety of Users.

A width of at least 3.0 m (10 ft) allows two pedestrians and a bicyclists traveling in the opposite direction to pass comfortably as illustrated in Figure 5-5.

Burlington



Burlington – Burlington Bike Path



Brunswick, ME



Shared use paths attract people of all ages and abilities. Each user has his or her own set of requirements.

### Bicyclists

Because riding on a path away from motor vehicles can be so appealing, shared use paths attract bicyclists whose age, skill and experience vary greatly.

Bicyclists use a wide variety of equipment including road bikes, hybrids, mountain bikes, tandems, trailers and trailer bikes, recumbents, tricycles (including hand bicycles) and even quadracycles (surreys). The most important characteristics of bicycles to the path designer are their sensitivity to surface texture and grade, their operating width (1.2 m [4 ft]), and the high speeds they can reach, especially on long paved downhill sections (over 50 km/h or 30 mph).

### Skaters

Skaters include in-line skaters, roller skaters and skateboarders. Many scooters also use skate wheels. While there are differences in the operating characteristics among these various types of skaters, they are similar enough to consider as one design category.

The small wheels of skates, typically 72 to 80 mm (2.8 to 3.1 in) diameter, make skaters especially sensitive to surface debris and irregularities, a factor that may be used to advantage where it is desired to prohibit skating in certain locations.

In-line skaters and scooters require at least as much lateral clearance as bicyclists, and may use as much as 1.8 m (6 ft) of width for operating space. The stopping ability of skaters is less than that of bicyclists, perhaps by 50 percent or more for novice skaters. To compensate for long braking distances, provide a level surface at least 9.0 m (30 ft) in advance of intersections, and a sight line of at least 30 m (100 ft) to accommodate beginning skaters.

### Other Users

Equestrian and snowmobile requirements are discussed in Chapter 6, Rail Trails.

## 5.3.2 Widths and Clearances

Design dimensions for shared use paths can vary greatly by the type of facility, levels of use they receive and the setting in which they are located.



Amherst, NY

In-line skaters require at least as much lateral clearance as bicyclists and may use as much as 1.8 m (6 ft) of width for operating space.

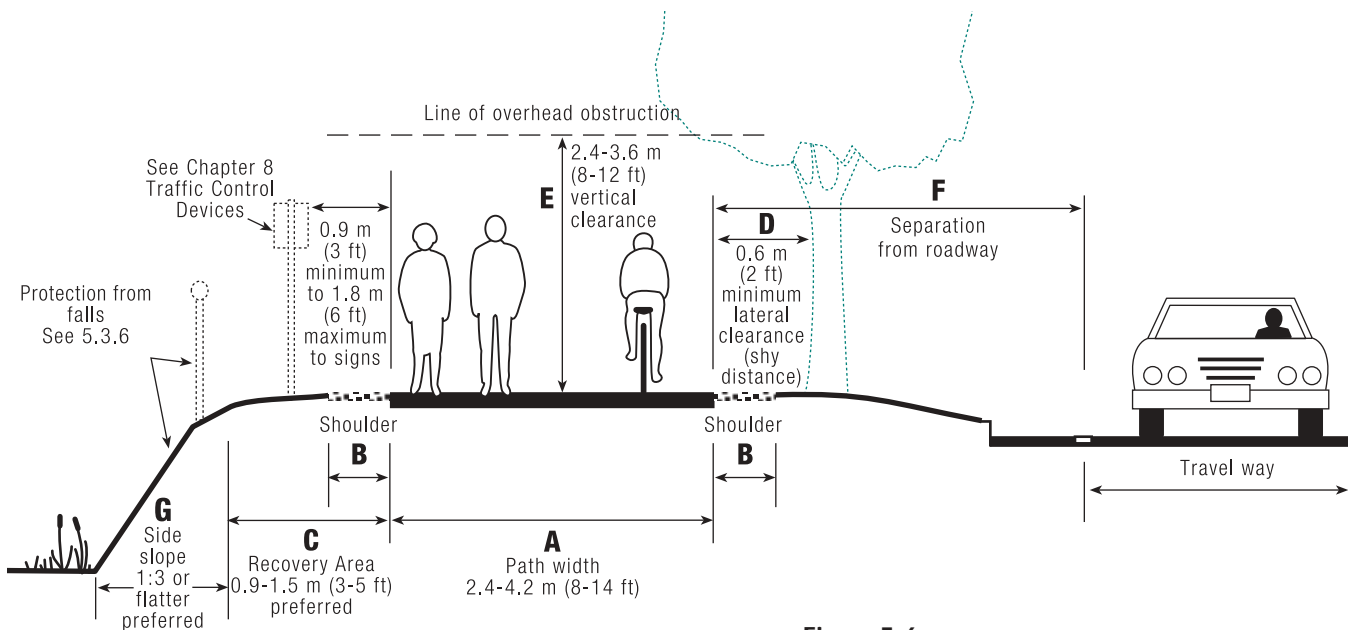

Figure 5-6.  
Shared Use Path, Typical Widths and Clearances.



**Path width (Dimension 'A')**

Design dimensions for shared use paths can vary greatly by the type of facility, levels of use they receive and the setting in which they are located. The recommended dimensions for path widths of a variety of shared use paths are listed in Table 5-1.

**Table 5-1.**  
Path Widths of Shared Use Paths (Dimension 'A').

Path Type	Minimum Path Width	Preferred Path Width
Paved Shared Use	2.4 m (8 ft)	3.0 to 4.3 m (10 to 14 ft)
Unpaved Shared Use	2.4 m (8 ft)	2.4 to 3.0 m (8 to 10 ft)
One-way Shared Use (rare)	1.5 m (5 ft)	1.8 m (6 ft)
Paved pedestrian-only	1.5 m (5 ft)	1.8 m (6 ft)

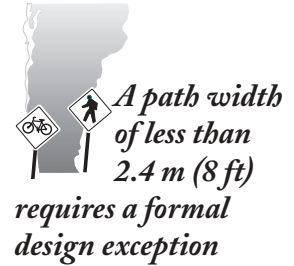

A combined path width greater than 4.2 m (14 ft) may be needed for separated bicycle, horse or running lanes. The minimum width of 2.4 m (8 ft) for shared use paths is recommended only when the following conditions prevail:

- Bicycle traffic is expected to be low, even on peak days or during peak hours.
- Pedestrian use of the facility is not expected to be more than occasional.
- Good horizontal and vertical alignment provides safe and frequent passing opportunities.
- The path will not be subjected to maintenance vehicle loading conditions that would cause damage to the edge of the pavement.
- No practical alternative design exists.
- Applicable path sight distance requirements can be met.
- For limited distances of up to 61.0 m (200 ft) to bypass a physical barrier (i.e., building, water body or other immovable objects).

**Shoulders (Dimension 'B')**

Shoulders provide pull-off, resting or passing space and should be graded to a maximum slope of 1:6. The preferred width of a shoulder on both sides of a shared use path is 0.6 m (2 ft).

**Recovery Area (Dimension 'C')**

A graded area of varying widths with a maximum slope of 1:6 from the edge of the path provides a recovery area for bicyclists who may ride off the path.

**Table 5-2**  
Recovery Area Widths

Slope	Unpaved Surface		Paved Surface		Barrier Recommendations
	Minimum	Preferred	Minimum	Preferred	
1:4 or flatter	0	0.6 m (2 ft)	0	0.9 m (3 ft)	Generally no barrier necessary
1:3	0.6 m (2 ft)	0.9 m (3 ft)	0.9 m (3 ft)	1.2 m (4 ft)	If vertical drop 1.5 m (5ft) or greater, consider use of barrier unless preferred recovery area provided
1:2	0.9 m (3 ft)	1.5 m (5 ft)	1.2 m (4 ft)	1.5 m (5 ft)	If vertical drop 1.2 m (4ft) or greater, consider use of barrier unless preferred recovery area provided
Steeper than 1:2	1.5 m (5 ft)	>1.5 m (5 ft)	1.5 m (5 ft)	>1.5 m (5 ft)	If minimum recovery area not provided, barrier is necessary



*Where conditions necessitate the use of less than the minimum width for lateral or vertical clearance, seek approval for less clearance through the VTrans Design Exception Process*

The width of the recovery area varies with the steepness of the adjacent side slope and the surface material of the path. Refer to Table 5-2 for additional details. If the minimum recovery area cannot be obtained a suitable barrier should be provided as described in section 5.3.6. If a side slope adjacent to the recovery area is a hard surface or has a hazard such as running water at its base, additional recovery area width or barrier protection along the top of the slope may be necessary. Similarly, if a side slope is on the outside of a curve on a downgrade, additional recovery area or barrier protection may be necessary.

#### **Lateral Clearance (Dimension 'D')**

The minimum clear “shy” distance to provide clearance from trees, poles, walls, fences, guardrails or other lateral obstructions (measured from the edge of the path) is 0.6 m (2 ft). Where space allows, the preferred shy distance is 0.9 m (3 ft). Note that the distance from the edge of the path to the nearest edge of a sign is a minimum of 0.9 m (3 ft) and a maximum of 1.8 m (6 ft) as prescribed by the MUTCD.

#### **Vertical Clearance (Dimension 'E')**

The minimum vertical clear distance to obstructions along a path is 2.5 m (8 ft). Where space allows, the preferred vertical clear distance is 3.0 m (10 ft). However, where equestrian use is permitted vertical clearance should be a minimum of 3.6 m (12 ft) and where snowmobile groomers are anticipated a vertical clearance of at least 3.0 m (10 ft) is desirable.

Provide continuous vertical clearance above all paths. Where maintenance and emergency vehicles use the path, or where there are under crossings or tunnels, provide the necessary vertical clearance dimension.

#### **Separation from Roadways (Dimension 'F')**

The minimum separation and buffer zone width between a roadway and a path in a curbed section is 1.2 m (4ft) and 1.5 m (5 ft) in an uncurbed section. In an uncurbed section at least 0.9 m (3 ft) of the 1.5 m (5 ft) buffer should be a green strip (see Chapter 3, section 3.4.3 Roadway Separation for a discussion of buffer zones and green strips. Where space permits, maximize separation between a path and the edge of an adjacent roadway. Where adequate physical separation cannot be obtained, physical barriers of sufficient height may also be provided as discussed under Side Slopes, Bridge Railings, Barriers, and Fencing in Section 5.3.6, below.

#### **Side Slopes (Dimension 'G')**

In general, fill slopes adjacent to shared use paths should be as flat as possible. Flatter slopes are less likely to require protective barriers, provide an area that errant bicyclists or other path users can traverse, and are generally less hazardous than steeper slopes. However, it is recognized that where paths are at significantly higher elevations than adjacent property, flat slopes may result in excessive overall project footprints. The surface material of the slope has an impact on path user safety, should users leave the path. Grassed or vegetated slopes are preferred versus crushed stone or rock (rip-rap) slopes.

### **5.3.3 Pavement Sections and Surfaces**

A shared use path should support the largest maintenance and emergency vehicles expected to use the facility. Construct paths in accordance with VTrans Standard Drawings A-78M and A-78 (to be developed) listed in the Appendix.

In general, paths have asphalt pavement surfaces or consist of other hard-surface materials. Recreational trails and paths in rural or semi-primitive settings can be constructed of materials that blend with the natural setting. However, regardless of

the surface material used the material must comply with the ADAAG requirements for firmness, stability and slip-resistance. See table 5.3 for a listing of ADAAG complaint surfaces.

### Concrete

Although not currently used in Vermont, Portland cement concrete surfacing for paths is known best for long-term use. It is the hardest of all path surfaces and is most often used in urban areas with severe climate changes or where flooding or heavy use is expected. Where concrete is used consider providing a soft-surface parallel path for runners or equestrians. A broom finish significantly improves the slip resistance of concrete. The use of concrete for paths in Vermont is not envisioned except in special circumstances.

### Asphalt

Asphalt (bituminous concrete) surfacing for paths is also an acceptable all-weather surface. Asphalt works well on paths that are used for bicycle commuting or in-line skating. However, under low snow conditions cross-country skiers and snowmobilers may find that snow melts more quickly on asphalt surfaces because the dark pavement absorbs heat from the sun. Also, the edges of an asphalt path can be more easily damaged than concrete by maintenance or emergency vehicles, or frost differential during the winter months.

### Crossings

At unpaved roadway or driveway crossings of paved shared use paths, pave the roadway or driveway at least 3.0 m (10 ft) on each side of the crossing to reduce the amount of gravel that may be scattered along the path by motor vehicles. The pavement structure at the crossing should also be designed to adequately sustain the expected vehicle loading at the crossing location.

### Sub-base

Consider the effects of freeze-thaw cycles on the path. Determine the need for any special provisions with a soils investigation of the load-carrying capabilities of the native soils, unimproved shoulder or former railroad bed (if ballast has been removed).

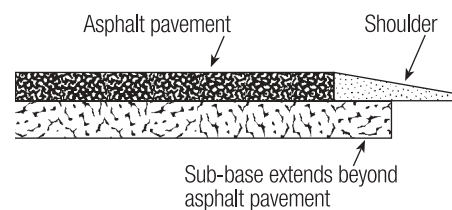

**Figure 5-7.**  
Sub-base, Asphalt Pavement.  
Extend sub-base beyond asphalt pavement.

A good sub-base, such as compacted aggregate material or fully compacted native soil (if structurally suitable) provides structural support of the path. If a path is constructed over a poor sub-grade, excavation to remove wet, organic or otherwise unsuitable material, treatment with soil-cement or application of a geotextile fabric may be required.

Remove all organic material, including roots, when preparing the sub-grade. The application of a soil sterilant or lime at the sub-grade level may be required to control the growth of new vegetation. Paths built in wooded areas typically require special attention. Roots of trees and shrubs can pierce the surface of the path or

cause it to heave and break apart. Preventive methods include removal of vegetation and realignment of the path away from trees.

### Unpaved Surfaces

Although hard, all-weather pavement surfaces are preferred on many paths, many operating agencies have found that compacted crushed aggregate as a surface material is less costly to install than asphalt or concrete. In addition, equestrians, joggers and other users prefer unpaved surfaces. Consideration should be given to unpaved surfaces in rural or natural settings. Table 5-3 illustrates the ability of different materials to meet ADAAG requirements.

Also, skaters are not drawn to unpaved paths and bicyclists' speeds are lower, making the path more comfortable for other users. However, in areas that are subjected to frequent or even occasional flooding or drainage problems, or in areas of steep terrain, unpaved surfaces may be more prone to erosion.

When unpaved crushed aggregate surfaces are used, spread a 10 cm (4 in) layer of material no larger than 8 mm (3/8 in) in diameter over a prepared sub base consisting of at least 15 cm (6 in) of crushed gravel over a suitable sub grade, and compact it with a roller. Care should be taken to match the size of the crushed aggregate materials with the expected use of the path and to ensure even gradation of



**Aggregate too large for any use. Beebe Spur Rail Trail, Newport, Vermont (before replacement)**

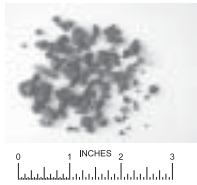

**Aggregate suitable for mountain bikes, marginal for hybrids, but too large for road bikes. Confederation Trail, PEI, Canada.**

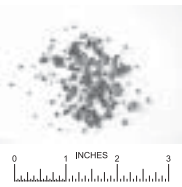

**Aggregate suitable for all bikes and wheelchairs. Youghiogheny Trail, Ohio, Pennsylvania.**

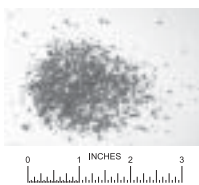

**Stone dust, suitable for bikes and wheelchairs. School St., Essex, New York**

**Table 5-3.**  
Suitability of Surface Materials for Shared Use Paths.

Surface Material	Firmness	Stability	Slip Resistance (dry conditions)
Asphalt	firm	stable	Slip resistant
Concrete	firm	stable	Slip resistant*
Soil with Stabilizer	firm	stable	Slip resistant
Soil with High Organic Content	soft	unstable	Not slip resistant
Crushed rock (3/4" minus) with Stabilizer	firm	Stable	Slip resistant
Crushed Rock w/o Stabilizer	firm	stable	Not slip resistant
Wood Planks	firm	stable	Slip resistant
Engineered Wood Fibers – that comply with ASTM F1951	Moderately firm	Moderately stable	Not slip resistant
Grass or Vegetative Ground Cover	Moderately firm	Moderately stable	Not slip resistant
Engineered Wood Fibers - that do not comply with ASTM F1951	soft	unstable	Not slip resistant
Wood Chips (bark, cedar, generic)	Moderately firm to soft	Moderately stable to unstable	Not slip resistant
Pea Stone or 1-1/2" minus Aggregate	soft	unstable	Not slip resistant
Sand	soft	unstable	Not slip resistant

Source: Adapted from Federal Highway Administration *Designing Sidewalks and Trails for Access, Part II, Best Practices Design Guide.*

aggregate material with enough fines to ensure compaction. In no case should the maximum diameter of the crushed aggregate exceed 8 mm (3/8 in). Refer to VTrans Standard Drawings for Shared Use Paths for additional details.

For supplemental parallel jogging or equestrian paths, materials such as wood chips or natural (earth) surfaces may be used provided the main path consists of an accessible surface.

#### 5.3.4 Grades

Shared use paths can be designed and constructed with various grades, depending on the level of accessibility being served and type of user anticipated.

On paths intended for use by pedestrians, grades should not exceed 5 percent to accommodate wheelchair users. ADA does allow for steeper grades, but requires provision of level “staging areas” at regular intervals.

Keep grades on paved shared use paths to a minimum, especially on long inclines. Grades greater than 5 percent are undesirable because the ascents are difficult for many path users to climb and the descents cause some path users to exceed the speeds at which they are competent or comfortable. On some shared use paths, where terrain dictates, designers may need to exceed the 5 percent grade recommended for short sections. As a general guide, the following grade restrictions and grade lengths are suggested:

5-6 percent for up to 240 m (800 ft)

7 percent for up to 120 m (400 ft)

8 percent for up to 90 m (300 ft)

9 percent for up to 60 m (200 ft)

10 percent for up to 30 m (100 ft)

11 percent or more for up to 15 m (50 ft)

*(Source: 1999 AASHTO Guide for the Development of Bicycle Facilities)*

If steeper segments are incorporated into the shared use path, the total running grade that exceeds 8.33 percent should be less than 30 percent of the total path length.

Where excessive path grades cannot otherwise be avoided, consider use of the following techniques:

- For paths with high levels of use, on steep grades, provide an additional 0.6-1.2 m (2-4 ft) of path width to provide room for slower bicyclists to dismount and walk.
- Use signs to alert bicyclists of the maximum percent of grade.
- Increase lateral clearances and recovery area dimensions.
- Provide a series of short switchbacks or level landing areas to contain the speed of descending bicyclists.
- Install a yellow centerline to better delineate travel lanes.

Additionally, if a stop condition is present at the bottom of an excessive grade a greater than minimum stopping sight distance should be used for design.

#### 5.3.5 Cross Slope and Drainage

If water is allowed to stand on paved path surfaces, algae may grow in warm weather and ice may form in winter months. The recommended maximum pavement cross-slope grade is 2 percent (1:48) on paved surfaces, to meet ADA requirements and to provide positive drainage. Bank curves to no greater than 2 percent superelevation with the low side on the inside of the curve to help bicyclists main-

tain their balance. On unpaved paths cross-slope can be as great as 5 percent, however less slope is preferred.

Sloping in one direction instead of crowning the path is preferred and usually simplifies the drainage and surface construction. On paved paths, a smooth surface is essential to prevent ponding. Pay particular attention to drainage on unpaved paths to avoid erosion.

Where shared use paths are constructed on hillsides, place ditches of suitable dimensions on uphill sides of the paths to intercept hillside drainage.

If tying into a closed storm water system, provide catch basins with drains where needed to carry the intercepted water away from the path. Locate drainage grates and utility covers at the outside edge of the path and flush with the path surface or off the path entirely. Install bicycle-safe drainage grates whenever catch basins are used in conjunction with shared use paths (refer to VTrans Standard Sheet D-15 and D-16). Set grates and utility covers flush with no raised edges, no greater than 1.3 cm (0.5 in) below the surface of the surrounding pavement.

To help prevent erosion in the area adjacent to the path, include methods for preserving the natural ground cover (i.e., seeding, mulching and sodding of adjacent slopes, swales and other erodible areas).

### 5.3.6 Barriers, Bridge Railings and Fencing

The placement of physical barriers adjacent to a shared use path serves many purposes including safety and security, protection from falls, screening of adjacent uses, separation of adjacent roadway or other conflicting uses (i.e., active rail line), vertical or grade separation, enhanced aesthetics (via berms, landscaping and plantings).

#### Design Considerations for Barriers

The design and selection of barriers adjacent to shared use paths is dependent on several factors including their intended function (i.e. protection from falls, separation of adjacent uses, delineation of property boundaries or screening), safety, proximity to the path, aesthetics and overall continuity of barrier type(s) within a path corridor.

#### Determining the Need for Protective Barriers

When the grade drops away severely from the shoulder of a pedestrian or bicycle travel way, protection from falls (provided by vegetation, fencing, or other physical barriers) may be required.

Determine the need to include protection along a shared use path on a case-by-case basis after evaluating the following factors:

- **Amount of recovery area available.** If an adequate recovery area (Dimension 'C' of Figure 5-6) is provided as outlined in Table 5-2, the need for a protective barrier is lessened.
- **Height.** The greater the height of a drop-off, the greater the need for protection. A protective barrier may be required when a vertical drop from the path surface to the base of the slope is more than 1.2 m (4 ft) in height,
- **Steepness of the slope.** Where the side slope is 1:3 or greater, the need for a protective barrier may be increased, unless the side slope material is forgiving (see next factor) or a suitable recovery area is provided.
- **Side-slope material.** If the material used on a side slope is grass, the need for protection is lessened. Shrubbery may also lessen the need for a physical barrier.

Riprap is considered a harmful material where the need for a protective barrier is increased.

- **Nature of hazard on or at the base of the slope.** If the consequences of colliding with a protective barrier would be less than the consequences of a crash at the bottom of a drop-off, a protective barrier should be strongly considered.

Where protection is required, provide it along the full extent of the grade drop.

**Barrier Types**

**Fences.** Fences are the most common types of physical barriers used on shared use paths. When using fencing as a barrier any number of fencing types that meet the minimum requirements for height are acceptable including, wooden, picket fence, pipe railing, wrought iron decorative fencing or vinyl-coated chain link.

**Walls.** Retaining walls should not be placed closer than 0.6 m (2 ft) from the edge of the path. High walls should be terraced back from the edge of the path shoulder since they may be out of scale with creating a pedestrian friendly environment. Blank walls may be screened with landscaping or designed with an attractive face or artwork. Wall materials may also vary from cast in place concrete or precast concrete, masonry or laid up stonewalls.

**Vegetation.** Trees, bushes or other sturdy vegetation capable of stopping a fall may be used as a barrier if new or existing individual plants are continuously spaced no greater than 1.8 m (6 ft) on center within 3.0 m (10 ft) of the path along the full extent of the grade drop. The density and species of plants in a vegetative barrier determine how effective the barrier can be in deterring access and protection from falls. Planted barriers typically take a few years before they become effective barriers and may need to be augmented with other temporary barriers. Where existing natural vegetation exists every effort should be made to avoid damaging the natural vegetation during the construction phase of a project. Vegetation also provides a visual barrier that helps channelize path users to the main path surface.

**Guardrail or Jersey Barrier.** Where concrete “Jersey” type barriers or guardrail are used as protective barriers (i.e., between a roadway and an adjacent path or sidewalk) placement of a railing or fencing on top of the barrier may be necessary to achieve the required minimum barrier height of 1.05 m (3 ft 6 in). When used in this scenario the barrier must also meet the applicable NCHRP cash test requirements for the adjacent roadway.

When any of these barrier types are used for purposes other than protection (such as right of way delineation, screening or others) and they are located outside the recovery area of the path, the required barrier heights do not apply.

**Barriers and Fencing Height**

Protective hand railings, barriers and fencing that are independent of bridges should be at least 1.05 m (3 ft 6 in) high. Where a bicyclist’s handlebar may come into contact with a fence or barrier, a smooth, wide rub-rail should be centered at a height of 0.9 m (3 ft). Hand railings, barriers and fencing in locations where cross-country skiing or snowmobiling is not anticipated should be designed to allow as much sunlight as possible to fall upon the path so snow and ice may melt as quickly as possible. An important design feature of barrier adjacent to paths is to flare the leading end of the barrier away from the path so that it does not become a hazard itself.

**Delineation**

In some cases, a section of a shared use path may be located immediately adjacent to a driveway, parking lot or other improved surface. In these cases, it can be

Ohioyle, PA



When closely spaced, trees, bushes or other sturdy vegetation capable of breaking and stopping a fall may be used in lieu of railings or fences

South Burlington



Equip protective railings where bicycle use is expected with rub rails centered at an average handlebar height of 0.9 m (3 ft).

Ohioyle, PA



A simple railing can offer protection where a vertical drop along a path is more than 1.2 m (4 ft) in height.



A shared use path may be delineated from a driveway, parking lot or other improved surface through the use of guardrail, fence or low landscaping.

hard to determine where the path ends and the adjacent facility begins. One way to delineate the two facilities from each other is through the installation of a physical feature, such as guardrail, fence or low landscaping. When a guardrail or fence is used for this purpose (i.e., not as a barrier to protect from hazards or falls), it does not need to meet the minimum height requirements for fencing as long as it is located with adequate lateral clearance from the path. When delineating the right-of-way with fencing it is recommended that woven wire mesh or traditional chain link fencing be used.

### Barriers Adjacent to Roadways

Where a guardrail is used as a barrier between a path or sidewalk and an adjacent facility and the back of the rail is 1.2 m (4 ft) or less from the edge of the path, a pipe rail or wooden rub rail should be mounted on the backside of the guardrail. When a W-beam guard rail with timber posts is used, and the sidewalk or path is 1.2 m (4 ft) or less from the back of the post, one of the following treatments of bolt ends should be used:

- Trim back the bolt flush with the face of the nut, or
- Countersink washers and nuts 25 to 38 mm (1 to 1½ in) deep.

### Bridge Railings

The minimum height of a protective bridge railing is 1.05 m (3 ft 6 in) . Where wintertime use of a shared use path is likely, the minimum height of a protective bridge railing is 1.35 m (4 ft 6 in). Railings on bridges should be designed so that a 15 cm (6 in) diameter sphere cannot be passed through the bottom 70 cm (27 in) of the bridge railing and a 20 cm (8 in) diameter sphere cannot be passed through the portion of the bridge railing above 70 cm (27 in). Additionally, bridge railings should be designed to discourage climbing.

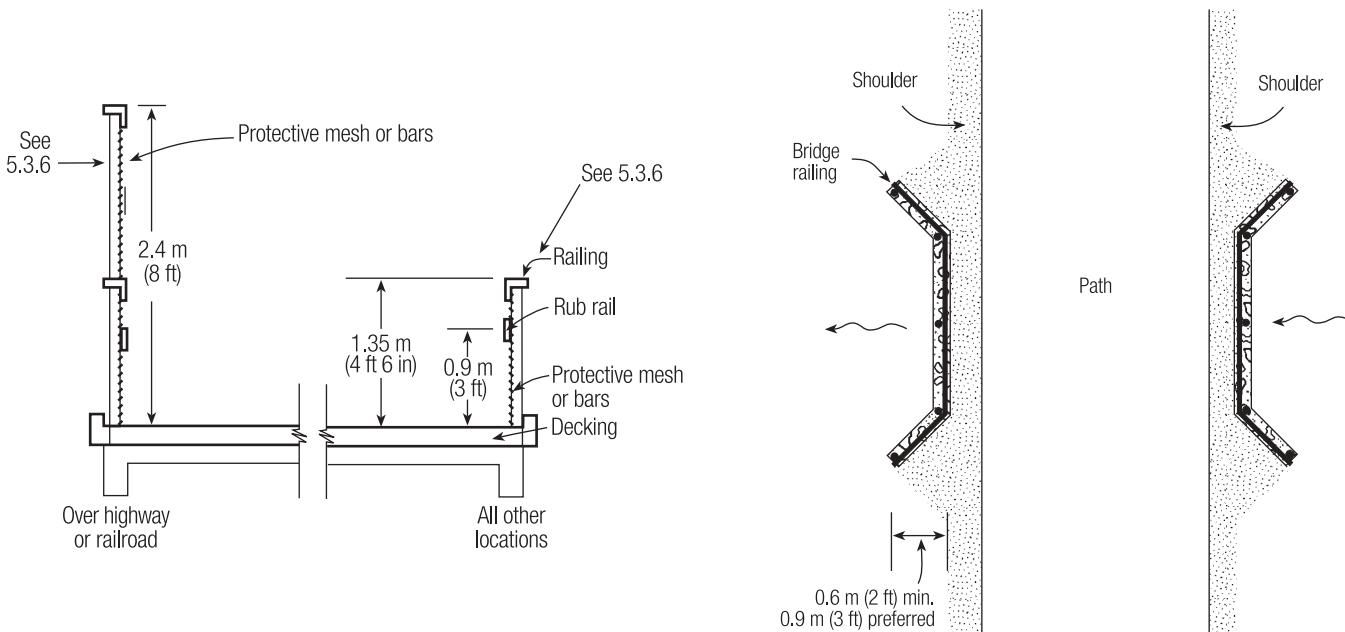

Figure 5-8.  
Bridge Railings.

Where a path bridge spans a highway or railroad track a 2.4 m (8 ft) high barrier fitted with wire mesh to the full height of the barrier may be provided along both



sides of the bridge to deter objects from being thrown from the path onto the facility below. This option should only be installed where this has been determined to be a problem.

### 5.3.7 Design Speed, Horizontal Alignment and Stopping Sight Distance

Engineering guidelines for bicycle design speed, horizontal alignment and stopping sight distance contained in AASHTO's 1999 edition (or current version) of the *Guide for the Development of Bicycle Facilities* are hereby made a part of this manual. Refer to the AASHTO Guide for relevant data tables and formulas. A brief summary of these topics is provided below.

#### Design Speed

Design shared use paths for a selected speed that is at least as high as the preferred speed of experienced (Group A) bicyclists. In general, this requires using a design speed of 30 km/h (20 mph) for paved or hard surface paths. Lower design speeds should not be selected to artificially lower user speeds. When a downgrade exceeds 4 percent for up to 240 m (800 ft) or more a design speed of 50 km/h (30 mph) should be used for such sections.

On unpaved paths, where bicyclists tend to ride more slowly, a lower design speed of 25 km/h (15 mph) may be used. Where the steeper grades on an unpaved path dictate, a higher design speed appropriate for conditions should be used.

#### Cross-slope/Super Elevation

Since most shared use paths built in the United States must also meet the requirements of the Americans with Disabilities Act (ADA), ADA guidelines require that cross slopes not exceed 2 percent (1:48) on paved surfaces and 5 percent (1:20) on unpaved surfaces. For most shared use paths, the maximum superelevation rate will be 2 percent (1:48). When transitioning a 2 percent (1:48) superelevation, provide at least 7.5 m (25 ft) transition distance between the end and beginning of consecutive and reversing horizontal curves.

#### Horizontal Alignment

The horizontal alignment, or curvature, of a path is dependent on the design speed, lean angle of bicycles and cross slope or superelevation of the path. The maximum practical lean angle of a bicycle is 25 degrees (before a pedal strikes the ground) and most bicyclists are not likely to lean more than 15 to 20 degrees. The AASHTO Guide for the Development of Bicycle Facilities (AASHTO Bike Guide) gives the following equations for calculating a minimum curve radius for different speeds and lean angles:

For Metric Units:

$$R = \frac{0.0079 V^2}{\tan A}$$

Where:

R = Minimum radius of curvature (m)  
V = Design Speed (km/h)  
A = Lean angle from the vertical (degrees)

For English Units:

$$R = \frac{0.067 V^2}{\tan A}$$

Where:

R = Minimum radius of curvature (ft)  
V = Design Speed (mph)  
A = Lean angle from the vertical (degrees)

The AASHTO Bike Guide also provides formulas for calculating curve radii when the lean angle approaches 20 degrees and the radius becomes more of a function of superelevation, coefficient of friction between the path and bicycle tires and bicycle speed. However, since the majority of path users are less experienced bicyclists and use of the previous equations yield slightly more conservative values, these

will be used. The following table gives minimum curve radii for different design speeds:

Table 5-4  
 Desirable Minimum Radii for Paved Shared Use Paths Based on 15 Degree Lean Angle

Design Speed (V)		Minimum Radius (R)	
km/h	(mph)	m	(ft)
20	(12)	12	(36)
25	(15)	18	(56)
30	(20)	27	(100)
40	(25)	47	(156)
50	(30)	74	(225)

Where project constraints such as right-of-way, topographical or environmental resources require that curve radii smaller than those shown in Table 5-4 be used, standard curve warning signs and supplemental pavement markings, such as centerline stripes should be installed in the vicinity of the curve. Widening the path through the area of the curve can further mitigate the negative effects of sharp curves. It is not necessary to provide a STOP or YIELD condition where these curves are located. However, it is common for paths to incorporate less than minimum radius curves as they approach a STOP condition. In that case apply the guidance as stated above.

**Stopping Sight Distance**

Adequate stopping sight distances provide bicyclists with an opportunity to see and react to the unexpected. The 1999 AASHTO *Guide for the Development of Bicycle Facilities* contains tables for minimum stopping sight distance for various conditions. These tables can be found in the Appendix of this manual.

Where there is an sight obstruction on the inside of a curve that restricts sight distance consider:

- Widening the path through the curve.
- Installing a yellow centerline stripe.
- Installing a curve ahead warning sign in accordance with the MUTCD, or some combination of these alternatives.

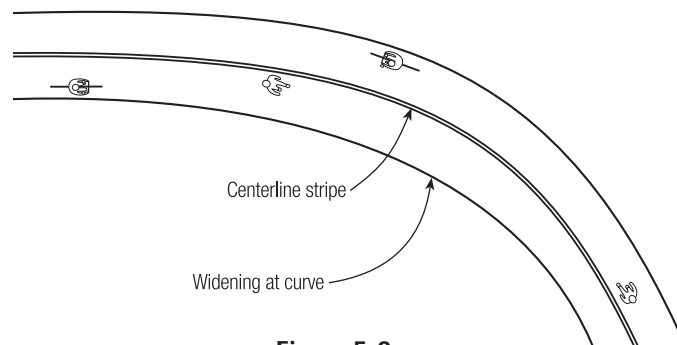

Figure 5-9.  
 Plan View of Shared Use Path Striping.

**5.3.8 Roadway and Railroad Crossings**

Path users are particularly vulnerable where a shared use path crosses a roadway. Consideration should be given to providing signing, lighting, pavement markings and other design elements to enhance safety at all shared use path and road crossings.

Minimize roadway and driveway crossing points as much as possible. Grade separation of paths is not generally feasible, therefore paths must connect to the street system and destinations in a safe and convenient manner.

**An overall guiding design principle is that path/roadway intersections should be designed to look and function like regular road intersections**, so that motorists and path users know what to expect and how to operate around the intersection. Refer to VTrans Standard Drawings - Path/Road Crossing Details and Shared Use Path Pavement Markings and Sign Details - for design details of intersections. Intersections should be designed using the following additional considerations:

#### *User Considerations*

- Design for the full spectrum of path users, young and old, slow and fast, pedestrians, bicyclists, skaters, and others.
- When assigning rights-of-way, give path users at least the same rights as the motoring public and provide clear right-of-way assignment.
- Provide positive guidance for path users and motorists to ensure full awareness of the intersection; for example, identify the crossing and who has the right of way.
- Design to assist the path user in looking in the direction of the potential hazard.
- Consider the potential for sun blinding.
- Consider lighting.
- Be consistent in design.

#### *Physical Features*

- Align the path as close to perpendicular to the road as possible, but not less than 70°.
- Minimize conflicts and separate conflicting movements.
- Design unavoidable conflicts to occur at right angles.
- Optimize sight triangles, with consideration for stopping, intersection crossing and decision sight distances. Make conflicts clearly visible.
- Reduce motor vehicle speed through traffic calming techniques as appropriate.
- Minimize path user crossing distance with a median refuge island or by narrowing the roadway as appropriate.
- Provide adequate staging and refuge areas for path users.
- Avoid obstacles and visibly highlight unavoidable obstacles.

#### *Access*

- Treat every road as a potential path entrance and exit point, integrated with sidewalks and on-street bicycle facilities as appropriate.
- Discourage unauthorized motor vehicle intrusion onto the path while enabling emergency, patrol and maintenance vehicle entry.

#### *Signals*

- At signalized intersections, minimize path user delay by minimizing traffic signal cycle time.
- Provide adequate signal crossing time for design pedestrians.
- At pedestrian-activated signals, consider the need for audible or vibro-tactile features.
- Consider the affect of vehicle turning movements on nearby path crossings.

### **Pavement Markings at Path Crossings**

Where shared use paths cross roadways, designers need to decide whether the crossing should include pavement markings. There are three ways to treat a path crossing:

- Use no pavement markings at the crossing location.
- Mark the crossing with standard pedestrian crosswalk markings.
- Mark the crossing with dotted guidelines, as indicated in the MUTCD.

One difference between a standard crosswalk marking and the dotted guideline is that use of the standard crosswalk marking will legally define the crossing as a crosswalk (VSA Title 23 Chapter 1 §4 (7) B). If a standard crosswalk is used, appropriate warning and advance warning signs need to be installed. It is standard practice to place crosswalks as close to perpendicular to traffic as possible. For details of both marking types, refer to Chapter 8, Signs, Pavement Marking and Signals.

Path users should be expected to use caution when crossing a roadway and pavement markings should only be provided where needed to raise motorists' awareness of the presence of a crossing or to provide path users with additional crossing guidance.

Designers should consider the following factors when deciding what level of marking is appropriate:

- Anticipated path volume.
- Traffic volume of the road being crossed.
- Number of lanes being crossed.
- Design or posted speed of the road being crossed.
- Anticipated types of path users.

Designers should also refer to the table in Chapter 3, Pedestrian Facilities for guidelines on appropriate locations for marked crosswalks. Marked crosswalks can be used to provide guidance to path users when the continuation of a path on the other side of the road is unclear. Where vehicle ADT exceeds 9,000 or the speed limit is 60 km/h (40 mph) or above, consideration should be given to locating the path crossing at a location where motorists are more likely to expect crossing movements or adding traffic control devices to facilitate safe crossings for path users.

### **Crossing multi-lane roadways**

Where three or more lanes are being crossed, a marked crossing with a refuge island should be provided. The safety of path users will be more greatly enhanced by the installation of a refuge island than by only marking the crossing.

At-grade path/roadway crossings may be categorized into three main types:

- Mid-block.
- Parallel path.
- Complex intersection.

Each of these types may cross any number of roadway lanes, divided or undivided, with varying speeds and volumes, and may be uncontrolled, or more typically, sign or signal controlled. Medians and refuge islands may be part of the design.

### **Mid-Block Crossings**

Mid block crossings are situations in which the path crosses a roadway far enough from any other intersection so as to be considered an independent intersection.

Ideally, path crossings should be at right angles to the roadway. Where the path alignment approaches a roadway alignment at an angle, provide an optimal 90-degree path approach and crossing as shown in Figure 5-10. If right-of-way is a constraint in providing for design speed curvature, the crossing may be angled a maximum of 75 degrees, thus reducing right-of-way requirements. This slight compromise will lengthen a crossing by only 4 percent.

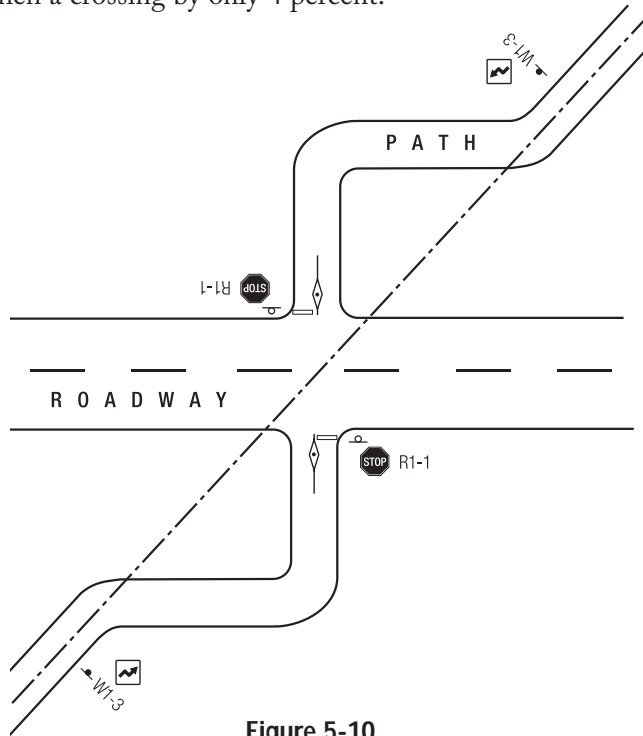

**Figure 5-10.**  
Diagonal Mid-block Roadway Crossing.

**Parallel Path Crossings**

Parallel path crossings occur where a path closely parallels a roadway and crosses another roadway near the intersection. With this configuration, the path user is faced with potential conflicts with vehicles turning from the parallel roadway and from the crossed roadway.

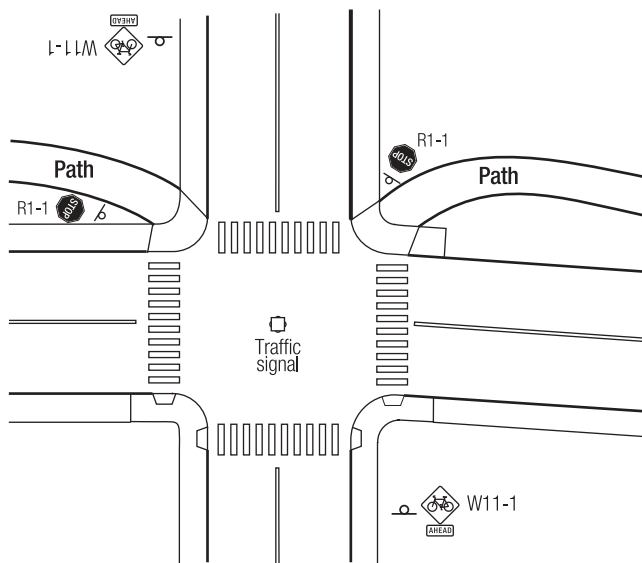

**Figure 5-11A.**  
Parallel Path Roadway Crossing Using Existing Crosswalk.

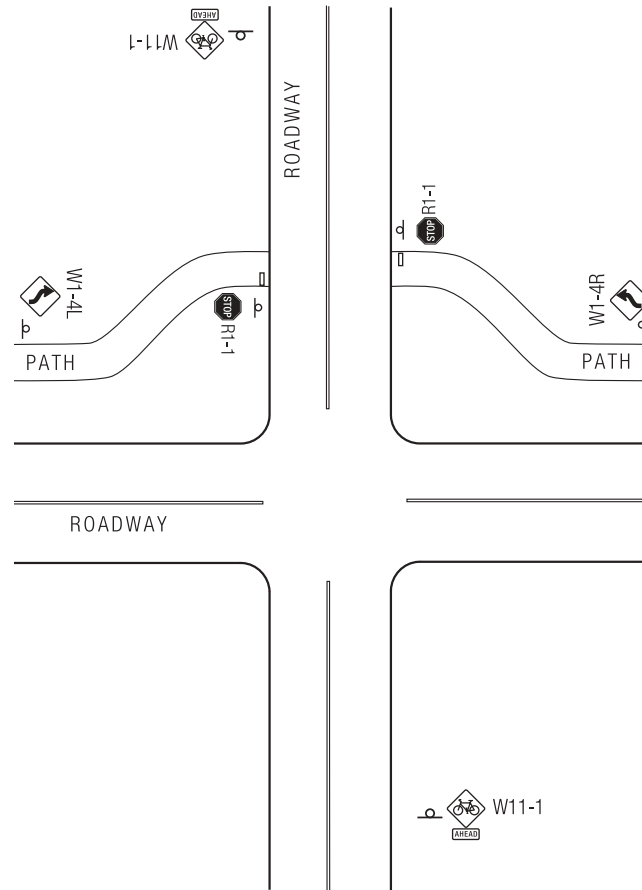

**Figure 5-11B**  
 Parallel Path Roadway Crossing. Provide Separation Between Path Crossing and Intersection

The major road may either be the parallel or the crossed roadway. Right-of-way assignment, traffic control devices and separation distance between the roadway and path greatly affect the design of this type of intersection. When this situation occurs two design options exist:

- Bring the path up to the intersection and encourage the use of existing crosswalks as shown in Figure 5-11A, or
- Increase separation between the path and road crossing and the intersection (see Figure 5-11B).

Further complicating the situation is the possibility of the conflicts being unexpected by both path users and motorists. Clear sight lines across corners are especially necessary.

Where a path crosses a roadway at an intersection, improve the path alignment to increase the visibility of approaching path users. This may be accomplished by curving the path slightly, so that it is not parallel to the adjacent roadway as shown in Figure 5-11A.

### Complex Intersection Crossings

Complex intersection crossings include a variety of configurations at which the path crosses directly through or near a roadway intersection and there may be any number of vehicular turning movements. View the junction from the perspective of

both the path user and motorist, and pay careful attention to potential conflicts from turning motor vehicles.

In certain situations a two-step crossing for path users may help isolate conflicts. This is typically done where, because of alignment constraints, the path-roadway intersection is skewed markedly from the 90-degree optimum and path realignment is not possible. If another intersecting roadway complicates the situation, a two-step crossing can establish right angle or nearly right angle maneuvers to simplify the crossing. Where an original path alignment would appear to be a more direct route to path users, use controls (such as path alignment and signs) to encourage path users to use the two-step crossing instead of the most direct route.

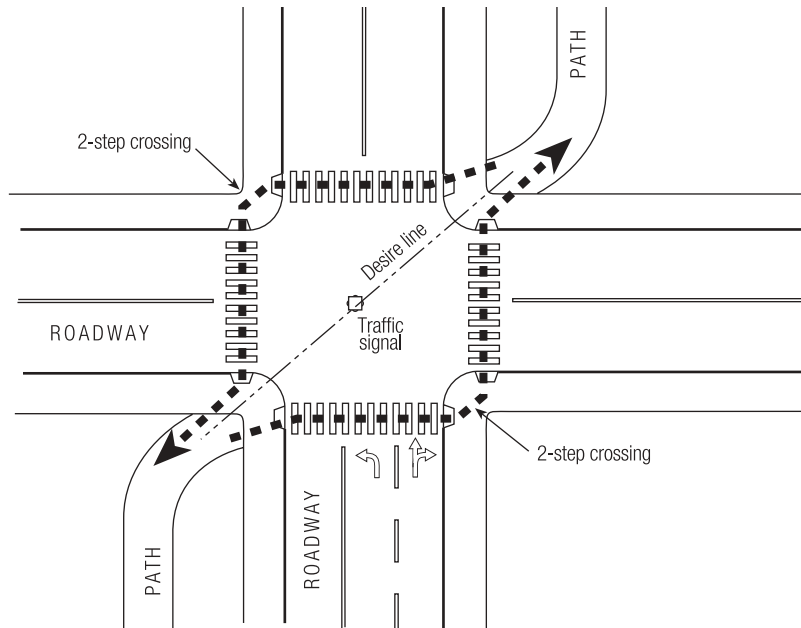

**Figure 5-12.**  
Complex Intersection Crossing.

Complex intersection crossings have many configurations and no single solution applies. Follow the principles of good intersection design listed above assisted by sound engineering judgment.

### Medians and Refuge Islands

Medians and refuge islands make it easier for path users to cross busy roadways. Consider refuge islands when one or more of the following conditions apply:

- High volumes of roadway traffic result in long delays to path users,
- Road width results in excessive exposure to traffic,
- The crossing will be used by a number of people who cross more slowly, such as the elderly, school children or people with disabilities, or
- When crossing three or more travel lanes.

Design refuge islands large enough to accommodate platoons of users, including groups of pedestrians, bicycles, tandem bicycles (which are considerably longer than single bicycles, especially if they are towing a child trailer), wheelchairs, people with baby strollers and equestrians (if this is a permitted path use).

The refuge island width should be a minimum of 2.4 m (8 ft) with a preferred width of 3.0 m to 3.7 m (10 to 12 ft) depending upon path usage. Angle the opening

in the refuge island at 30 degrees so that path users waiting in the refuge island are forced to observe oncoming traffic in the far travel lane(s) of the roadway before completing the crossing. Provide adequate space so that those in the refuge island do not feel threatened by passing motor vehicles while waiting to finish the crossing.

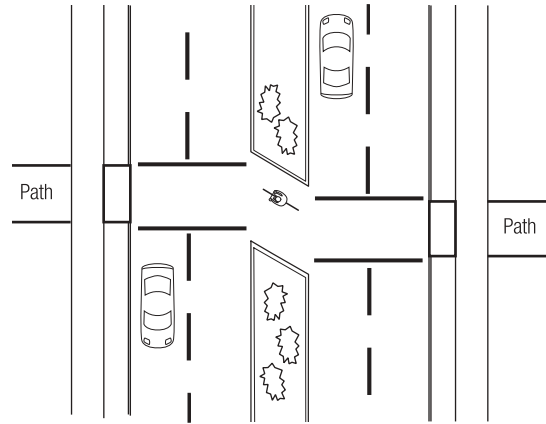

**Figure 5-13.**  
Roadway Crossing with Median.

### 5.3.9 Managing Motor Vehicle Access

Where paths intersect with the road network, provision should be made to restrict motor vehicles from entering the path. Refer to VTrans Standard Drawing Railroad/Road Crossing Details for details. Unauthorized vehicles can be discouraged from entering paths through the use of gates, splitter islands, short curb radii, and bollards.

#### Gates

Gates can be designed to allow passage for pedestrians and bicycles while barring access to motor vehicles. However, gates are the least effective way to limit unauthorized vehicle use because they can also limit authorized users, they are expensive to maintain and they are vulnerable to vandalism.

#### Splitter Islands

Motor vehicles can be restricted from entering paths through the use of a split path configuration. In this configuration, a two-way path branches into two one-way paths just before it reaches the roadway, making it difficult for a motor vehicle to gain access to the path. If the area between the one-way paths is designed with low vegetation and no fixed objects, emergency vehicles can drive over the splitter island if it becomes necessary to gain access to the path. When splitter islands are used appropriate signing and striping for path users should be provided.

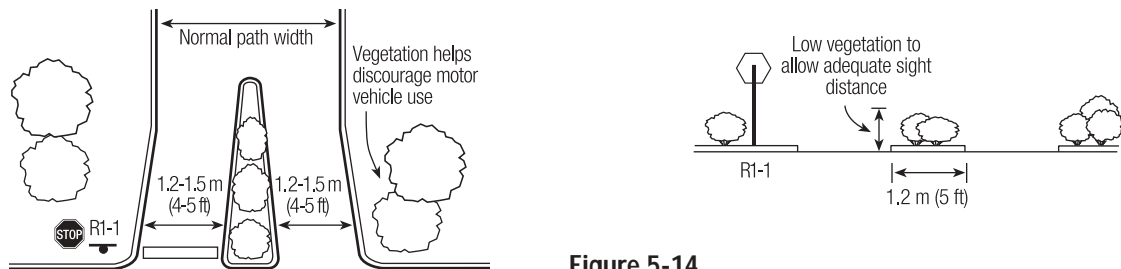

**Figure 5-14.**  
Splitter Island.



**Short Curb Radii**

Short curb radii 1.5 m (5 ft) in length make it difficult for motorists to enter a path from a roadway.

**Bollards**

Bollards (barrier posts) may be used to limit vehicle traffic on paths. However, bollards can be a hazard, particularly under low light conditions to bicyclists who do not see or expect them.

Space bollards at least 1.5 m (5 ft) apart to permit easy passage by bicyclists, bicycle trailers and wheelchair users. Where unauthorized motorized use such as ATV's and snowmobiles are a problem a minimum of 0.9 m (3 ft) separation is recommended. However, reduced bollard spacing should only be considered where a specific problem has been identified. On two-way facilities, a single bollard should be centered in the path. If more than a center bollard is needed, an odd number of posts should be used, with the outside bollards placed outside the edge of the paved area at the path edges.

Bollards, when used, should also be set back from the intersection by 1.5 m – 3.0 m (5-10 ft) behind the path stop bar and should include a Type II object marker on both sides for nighttime visibility. Where bollards are used on paved paths pavement markings around the bollards should be provided as shown in Figure 5-15.

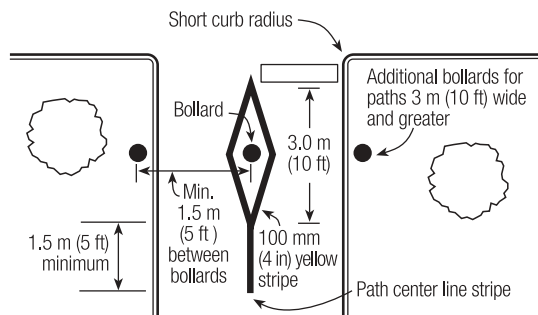

**Figure 5-15.**  
Bollards.

Bollards may be used to manage motor vehicle access.

**Chicanes**

There is a type of barrier that is not recommended for use where a shared use path crosses a roadway. This barrier type includes chicanes or “bicycle mazes” that require bicyclists to dismount and negotiate the barrier one person at a time. Chicanes can pose a hazard to path users for the following reasons:

- Like bollards they place a physical obstruction within the path of users. However, the maze-like effect of a chicane can greatly increase the probability of a crash.
- A chicane creates an obstacle for path users crossing the street which increases the likelihood that platoons of path users may be trapped in the roadway and exposed to traffic longer than a traditional stop condition.
- To adequately accommodate the varying dimensions of path users including tandem bicycles, bicycles with trailers, wheelchair users, the visually impaired or equestrian users, the dimensions of the chicane may be such that the maze effect is lost, thus reducing its intended effect.
- Path users may divert away from the chicane and bypass it altogether.

Brunswick, ME



**Bollards may be used to manage motor vehicle use . . .**

Brunswick, ME



**. . . but need to be designed to permit access for maintenance and emergency vehicles.**

Beebe Plain – Beebe Spur Rail Trail



**Wood bollards help maintain a rustic appearance.**

Confluence, PA



- Chicanes limit authorized emergency and maintenance vehicle access to the path.

For these reasons chicanes are not recommended for use where a shared use path crosses a roadway. Designers should design intersections using the concepts and guidance provided in section 5.3.8 and general transportation design principles. Designing intersections that look and function like traditional vehicle intersections supports road and path user expectations. Problems associated with at-grade path crossings often relate to motorists' expectations of entries onto the roadway. The best practice is to follow established principals of intersection design and provide signing, lighting, pavement markings and enforcement, if problems occur, to enhance safety at path roadway intersections.

### 5.3.10 Structures

Structures such as bridges or underpasses can provide continuity along a shared use path.

In most cases, the rail-to-rail clear bridge width should equal the approach width plus a shy distance of 0.6 m (2 ft) on each side of the bridge. In rare instances it may be appropriate to reduce the shy distance to 0.3 m (1 ft) on each side. However, this should only be done if all of the following criteria are met:

- Overall path use is expected to be low.
- Bicycle traffic is expected to be low, even on peak days and hours.
- To reduce the total footprint of the project.
- Where frequent stopping of path users on the structure is not anticipated.
- When adapting an existing structure.
- Approaches to the bridge provide adequate sight distance.
- Good horizontal and vertical alignment is provided.

Carrying a clear area across a structure has two advantages. First, the clear width provides the minimum horizontal shy distance from the railing or the barrier, and second, it provides needed maneuvering space to avoid conflicts between path users who may have stopped on the structure. Therefore, in most cases the minimum structure width would be 3.6 m (12 ft) rail to rail.

In establishing the design clearances of shared use path structures, plan for access by maintenance, patrol and emergency vehicles. Similarly, vertical clearance should be designed with such vehicles in mind. In any case, a minimum vertical clearance of 2.4 m (8 ft) is required for all structures. A vertical clearance of 3 m (10 ft) is preferred. Where snowmobile grooming equipment is anticipated, a 3 m (10 ft) clearance is desirable, as is a 3.6 m (12 ft) clearance for equestrian users.

### Bridges

Bridges are among the most challenging design elements of shared use paths because each one is site specific. Safety is the primary concern in bridge design. Determine its design load (or structural capacity to support and withstand predictable weights and forces during its projected life span) through engineering analysis.

Many paths use prefabricated bridges, which are pre-engineered, constructed off-site, delivered to the site by the manufacturer for final assembly, and placed onto footings by a crane. Bridge design should accommodate light duty maintenance and emergency vehicles. The current practice for shared use path bridges is H10 loading or a 10-ton load for a two-axle vehicle.

An important element of the overall bridge design is its approach. For safety reasons, and because bridges tend to be a natural stopping point for path users,

Stowe



Many trails use prefabricated bridges, which are pre-engineered, constructed off-site, delivered to the site by the manufacturer, and lifted onto appropriate footings by a crane.



### Underpasses and Overpasses

There are both advantages and disadvantages to underpass and overpass structures.

Underpasses provide an opportunity to reduce approach grades as the 3 m (10 ft) clearance is less than the clearance required for a path over a roadway or railroad. If a roadway is elevated, an under crossing can be constructed with little or no change in grade. Therefore, under crossings are often less expensive to build.

Under crossings, however, may present security problems due to the reduced visibility and light levels. An open, well-lit structure may cost as much as an over crossing. Underpasses may also require drainage if the low point is at a lower elevation than the surrounding terrain.

A vertical clearance of at least 3 m (10 ft) is preferred for under crossings. However, a minimum clearance of 2.4 m (8 ft) may be acceptable if a greater clearance is not needed for maintenance or emergency vehicles, and users approaching the structure have an unobstructed view all the way through the underpass. Illumination is needed in under crossings where visibility is poor, however, light fixtures should be designed to withstand vandalism.

Overpasses are more open and present fewer security problems. However, overpasses typically require longer approaches to achieve the standard 5 m (17 ft) clearance required over most roadways and 7 m (23 ft) over most railroad tracks. When the depth of the overpass structure is taken into account, approach ramps configured at a 5 percent grade could be required as much as 150 m (500 ft) in each direction, or as much as 300 m (1,000 ft) overall.

Brunswick, ME



A vertical clearance of at least 3 m (10 ft) is preferred for undercrossings.

Ohioypyle, PA



Brunswick, ME



Shared use paths should include frequent rest areas and benches, preferably shaded from the elements seasonally.

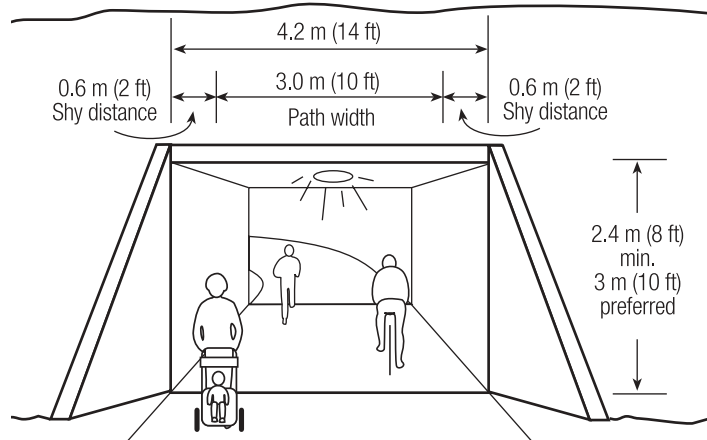

Figure 5-17.  
Shared Use Path Underpass.

### 5.3.11 Supplemental Facilities and Amenities

As with other pedestrian facilities, shared use paths should include frequent rest areas and benches shaded from the sun. Picnic tables also add to the attractiveness and usefulness of a path. Other amenities may include lighting, drinking fountains, mile markers etc. Refer to Chapter 9, Landscaping and Amenities for guidance regarding amenities.

## ***5.4 Construction Zones and Temporary Access***

If construction on or adjacent to a shared use path is necessary, consideration should be given to the provision of temporary traffic controls to warn and direct path users and to allow workers to safely achieve their task. Continuity of the access provided by the path is a key consideration in establishing temporary traffic controls. For a more detailed discussion, refer to Section 8.4.4.

## ***5.5 Additional Resources***

Consult the following resources for the broadest coverage of issues relating to the planning and design of shared use paths:

- *Designing Sidewalks and Trails for Access: Best Practices Design Guide*, Federal Highway Administration, 2001.
- *Guide for the Development of Bicycle Facilities*, American Association of State Highway and Transportation Officials (AASHTO), Washington, DC. 1999.
- *Manual on Uniform Traffic Control Devices*, Millennium Edition, Federal Highway Administration, Superintendent of Documents. P.O. Box 371954, Pittsburgh, PA 15250-7954. 2000.
- *Trail Intersection Design Guidelines*, Florida DOT, available via the Internet. 1996.
- *Trails for the Twenty-First Century*, Second Edition, Rails-to-Trails Conservancy, 1100 17th Street, N.W., Washington, DC 20036.
- *Universal Access to Outdoor Recreation: A Design Guide* (USDA Forest Service and the PLAE).



CHAPTER 6:



# Rail-Trails and Rails-With-Trails

## *Contents*

6.1 Introduction .....	6-3
6.1.1 Characteristics of Rail-Trails .....	6-3
6.1.2 Enabling Legislation .....	6-6
6.1.3 Application .....	6-6
6.1.4 Historic References .....	6-8
6.2 Design .....	6-9
6.2.1 User Requirements .....	6-9
6.2.2 Widths and Clearances .....	6-11
6.2.3 Pavement Sections and Surfaces .....	6-14
6.2.4 Grades .....	6-15
6.2.5 Cross Slope and Drainage .....	6-15
6.2.6 Side Slopes, Bridge Railings, Barriers and Fencing .....	6-15
6.2.7 Design Speed, Horizontal Alignment and Stopping Sight Distance .....	6-16
6.2.8 Crossings .....	6-16
6.2.9 Managing Motor Vehicle Access .....	6-17
6.2.10 Structures .....	6-18
6.2.11 Supplemental Facilities and Amenities .....	6-20
6.3 Additional Resources .....	6-20

## *Figures*

6-1 Strategies for Sub-Optimal Trail Widths: Locate Trail at the Bottom of a Slope .....	6-11
6-2 Strategies for Sub-Optimal Trail Widths: Use an Adjacent Utility Corridor .....	6-11
6-3 Strategies for Sub-Optimal Trail Widths: Widen the Berm .....	6-11
6-4 Strategies for Sub-Optimal Trail Widths: Excavate the Slope and Buttress With a Retaining Wall .....	6-11
6-5 Strategies for Sub-Optimal Trail Widths: Use a Low Retaining Wall to Increase the Width .....	6-11
6-6 Strategies for Sub-Optimal Trail Widths: Excavate the Top of the Berm .....	6-11
6-7A Lateral Clearance Requirement, Rails-With-Trails .....	6-13
6-7B Recommended Setback, Rails-With-Trails .....	6-13
6-8 Creating a Temporary Pedestrian Path When Crossties and Rails Remain .....	6-15

***Rail-Trails and Rails-With Trails***

6-9	Agricultural Crossing .....	6-17
6-10	Seasonal Plank Runners .....	6-18

***Tables***

6-1	Snowmobile Trail Classes .....	6-10
6-2	Designing for Low Levels of Use on Narrow Trails .....	6-12
6-3	Minimum Separation from Active Rail Line .....	6-13



## 6.1 Introduction

Rail-trails (RT) and rail-with-trails (RWT) are a unique type of shared use path. Rail-trails use inactive, abandoned or railbanked railroad corridors. Rail-with-trails share a corridor with an active railway. To simplify the terminology, in this chapter the term rail-trail is used to reference both facility types, and rail-with-trail applies only to active shared railroad corridors.

Like shared use paths, rail-trails are used by bicyclists and pedestrians, including walkers, joggers, runners, people with baby strollers, skaters, and people walking dogs. During winter months, rail-trails may be used for cross country skiing, snowshoeing and snowmobiling, where permitted. The facilities should take into account the various capabilities, needs and characteristics of a wide range of users.

This chapter covers the planning and design of rail-trail conversions. Not included are issues relating to insurance, liability, lease agreements with rail-trail managers, or the operation of rail-trails.

### 6.1.1 Characteristics of Rail-Trails

Many of the characteristics of shared use paths (refer to Section 5.2.1) are also common to rail-trails and rails-with-trails. These include: continuous separation from motor vehicle traffic; frequent access points; increased levels of safety and security; scenic qualities; connectivity to a variety of land uses; well-designed street and driveway crossings; potential for shorter trips; activity; uniform design and good engineering; informative signing and marking; context sensitive design and aesthetics; regular inspection and maintenance and potential for making an economic contribution to the community.

In addition, rail-trails have many unique characteristics that set them apart from shared use paths:

- Ownership, operation and maintenance.
- Existing infrastructure.
- Alignment.
- Grade.
- Geometrics.
- Drainage.
- Scenery.
- History.
- Distance markers.
- Community support.
- Remoteness.
- Contamination and deterioration.
- Potential for making an economic contribution to the community.

1. **Ownership, Operation and Management.** The issues surrounding ownership, operation and management of a rail corridor, whether active or inactive, are often complex. If a corridor is intact, it may be owned or leased by a governmental entity or by private interests. Use of the corridor for railroad or trail

Swanton – Missisquoi Valley Rail Trail



Swanton – Missisquoi Valley Rail Trail



Burlington – Burlington Bike Path



Rail-trails and rail-with-trails are a unique type of shared use path. Like shared use paths, rail-trails are used by bicyclists and pedestrians. During winter months, rail-trails may be used for cross country skiing, snowshoeing and snowmobiling.

*Rail-Trails and Rails-With Trails*

purposes can be the responsibility of the corridor owner or it may have been legally assigned to others through a lease, easement, cooperative agreement or finance and maintenance agreement.

If ownership of a former railroad corridor has reverted to adjacent landowners, each landowner will have a say as to whether the land may be used for trail purposes. Whatever the case, expect that all interested parties will need to be involved in the development of the trail.

For state owned railroads, historic deed information appears on valuation sheets maintained by the Rail Division at the Agency of Transportation. Be cautious when using valuation maps, however, because they may not have been fully updated to reflect current ownership. Where ownership is in question, consult deeds, town property records or other resources that may have been produced when the corridor was constructed.

2. **Existing Infrastructure.** The sub-base, superstructure, drainage, bridges, and crossings are already established. Design is often a matter of working with or adapting the existing infrastructure to meet the needs of a rail-trail.
3. **Alignment.** The alignment of a rail corridor is already fixed and known. Except for linkages to other parts of the pedestrian and bicycle network, or for certain roadway or water crossings, there is little uncertainty about the rail-trail location. Rail-trails are typically “straighter” than shared use paths to accommodate the needs of trains, a characteristic that can be used to advantage in connecting destinations.
4. **Grade.** Railroad grades are limited to 1:20 (5 percent) or less. Grades of 1:40 (2.5 percent) are more often the norm. As a result, the grades along a rail corridor are usually more moderate than a shared use path. This makes rail-trails appealing to many walkers and bicyclists, and somewhat easier to adapt to ADA guidelines.
5. **Geometrics.** The steep side-slopes and generous widths and clearances of a rail corridor — designed for large rail equipment — can be cost effectively adapted for use as a rail trail. These geometric features should be maintained because there is always the possibility of returning an inactive railroad corridor to active rail service.

*Side slopes and shoulders:* To maintain a moderate gradient, railroad corridors were often constructed with taller fills and deeper cuts. Depending on the material used to support the loads of a railway facility, existing side slopes along rail embankments may be as steep as 2:1.

*Horizontal widths and clearances:* Right-of-way widths vary greatly but average from 4 to 5 rods (20 to 25 m [66 to 83 ft]). Horizontal clearances for train use vary depending on the curvature or lack of curvature of the track. All fixed objects should be kept well outside the dynamic envelope of the train.

*Vertical clearances:* The standard vertical clearance over a railroad track is 7 m (23 ft), measured from the top of the rail. If converted to a trail, clearance for equestrians and snowmobile grooming equipment should also be considered (when these uses are permitted).

6. **Drainage.** Rail beds were built to exacting design specifications to direct and move water away from them. When the corridors are in active use, railroad crews regularly inspect and keep side areas clear, drainage ditches cleaned out, drainage ways open, and water moving. Without an aggressive maintenance program, vegetation may take over, drainage may become blocked, beavers can

create dams that cause water to backup, or property owners may modify drainage at crossings. Ongoing maintenance programs are required to preserve and protect the corridor from the elements (refer to Chapter 10, Maintenance).

7. **Scenery.** Because the grade of a railroad needs to be as level as possible, railroad corridors were often located along natural features such as waterways and valleys where the grades are most level and the scenic attributes can be exceptional.
8. **History.** Evidence of prior railroad activity can still be found along a railroad corridor or in the collections of railroad enthusiasts. It's important to utilize such artifacts to recall early days of transportation. Relics suitable for a rail-trail project can include: mile markers; whistle signs; antique grade crossing signs; grade crossing signal relay cabinets; signal bridges; semaphores; telegraph poles and insulators; stations and depots; workers' shelters; storage warehouses; stone abutments; and viaducts, bridges and trestles.

In addition to these remnants, rail-trails also traverse parts of cities and the countryside that highlight bygone eras of development and industrialization, such as factories housed in brick buildings, as well as silos and barns in agricultural areas. These structures, and the corridors they occupy, epitomize the progress of American industry, engineering and labor, thus educating trail users about the route's history. When combined with the stories of people who built them, these features give a rail-trail a "sense of place," strengthening a user's understanding of, and connection to, the trail and its surrounding region.

Photographs, maps, advertisements, timetables and brochures can also be used to generate interest and user support in rail-trail projects.

9. **Distance markers.** All railroad corridors have mile markers, whether physically located along the corridor, indicated on land records and valuation sheets, or both. However, unlike distance markers recommended for shared use paths, which usually begin at a trailhead, mileage indications for railroad use may begin miles away from a trailhead or even in a distant state or country. Railroad mile markers have legal as well as historic significance and should not be removed. Rather, use both path-based and railroad-based distance markers and show their locations on user maps for geographic and historic reference.
10. **Community Support.** Many railroad enthusiasts and groups follow and support activities that preserve the history and romance of the railroad. Rail-trail advocates, such as the Rails-to-Trails Conservancy, can also be an important source of citizen support and technical expertise for planning, designing and maintaining rail-trail facilities. Include them as active partners in rail-trail development projects from the outset.
11. **Remoteness.** For a variety of functional reasons, railroad corridors are aligned away from activities, services and cultural experiences that are normally accessible by streets and roads. While this may provide welcome solitude for some rail-trail users, such an experience may be monotonous to others and even threaten personal safety and security. Taking advantage of opportunities to link the corridor back to the roadway system or other bicycle and pedestrian networks as well as providing visual connections to off-trail activity at regular intervals can help overcome these concerns.
12. **Contamination and Deterioration.** Railroad corridors can be the site of environmental contamination due to past spills and freight derailments. The soil along a rail corridor may have become contaminated and an environmental or

Prince Edward Island, Canada



Retain and use artifacts of prior railroad activity to give rail-trails a "sense of place," strengthening users' understanding of, and connection to, the trail and its surrounding region.

Swanton – Missisquoi Valley Rail Trail



Rail-trail advocates can provide an important source of citizen support and technical expertise for rail-trail facilities.

**Rail-Trails and Rails-With Trails**

soils analysis may be required. Similarly, if a former rail yard is to be a part of the future rail-trail corridor, spillage of lubricating oil and other substances may require hazardous waste removal.

Structural deterioration of existing bridge piers, abutments and retaining walls may have occurred. Structures subjected to flowing water or ice flows may be undermined or weakened, requiring a bridge scour analysis to determine their condition and feasibility of reuse.

**13. Economic Development Potential.** Rail-trail corridors provide recreation, conservation and land value benefits long after the rail line becomes inactive. They are valued for their ability to connect people with places and to enhance the beauty of developed areas. Rail-trails stimulate tourism and recreation-related spending for lodging, food, services, and supplies. They can be the central focus of tourist activities in some communities. Rail-trails preserve critical open space that provides natural buffer zones between development and natural areas. They increase the natural beauty of communities, and have been shown to bolster property values.

Aside from the utilitarian nature of the rail-trail and its related support facilities, the economic contribution a well-developed and attractive rail-trail can make toward state and local economies should be weighed in planning and design decisions.

Railroad corridors provide a direct connection to population centers and employment centers. As a result they are well suited to provide direct transportation links independent from the roadway system. In addition, rail-trails can provide long distance off-road connections between points of interest, outdoor recreation activities, and economic development opportunities.

### 6.1.2 Enabling Legislation

The development of rail-trails has been made possible by legislation at the state (see VSA Title 5, Section 3408) and federal levels (USC, Title 16, Chapter 27, Section 1247(d), also known as “the Trails Act”).

**VSA Title 5, § 3408. Railbanking.** Empowers the Secretary of Transportation to place a state-owned railroad property not economically feasible under present conditions in railbanked status and permits the agency, on behalf of the state, to hold the right-of-way of a railbanked line for reactivation of railroad service or for other public purposes not inconsistent with future reactivation of railroad service.

**USC, Title 16, Chapter 27, Section 1247(d) Interim use of railroad rights-of-way.** The Trails Act directs the U.S. Secretary of Transportation, the Chairman of the Surface Transportation Board, and the Secretary of the Interior to encourage State and local agencies and private interests to establish appropriate trails for interim uses through the provisions of the Railroad Revitalization and Regulatory Reform Act of 1976 in order to preserve established railroad rights-of-way for future reactivation of rail service and to protect rail transportation corridors.

### 6.1.3 Application

#### Railroads and rail-trails in Vermont

In 2000, there were about 1213 km (754 mi) of railroad corridor in Vermont:

Owned by private companies.....	563 km (350 mi)
Owned by the State of Vermont .....	650 km (404 mi)
Leased to railroad operators .....	526 km (327 mi)
Rail-trails .....	124 km (77 mi)

For a current map of railroad owners, operators and corridor locations refer to [www.aot.state.vt.us/omc/images/rrmap.jpg](http://www.aot.state.vt.us/omc/images/rrmap.jpg). The map includes some, but not all, rail-trail installations.

Although the principal purpose of developing a rail-trail along an inactive or abandoned railway corridor is to provide transportation and recreation opportunities for non-motorized users, rail-trails can also provide significant benefits to the railroad industry. The fundamental precept of the federal railbanking legislation is the preservation of inactive railroad corridor for future railroad use.

Rail-trail development need not be limited to inactive or abandoned corridors. Locating a rail-trail along an active railway (rail-with trail) can safely extend Vermont's network of pedestrian and bicycle facilities and presents the greatest opportunity for future rail-trail development. Vermont is in a unique position because more than 50 percent of Vermont's railroad corridors are currently owned by the State. FHWA's *Rails-with-Trails: Best Practices Report* (2001) suggests that people nationwide are using and enjoying rail-trails located along active rail lines as communities work with railroad operators to develop, operate and maintain rails-with-trails. Existing rail-with-trail installations can be found in Montpelier, Burlington and Newport.

Rail-with-trails provide the added benefit of allowing railroad operators an opportunity to better regulate unauthorized access and therefore reduce trespassing and risk. Rail-trails also improve access for routine maintenance and security patrols as well as for emergency vehicles. Railroad corridors can be used as a utility corridor for fiber optics, gas transmission, water, sewer or other pipelines.

There are four levels of railroad corridor activity and inactivity:

- Active corridors.
- Inactive corridors that remain under the control of the owner and/or lessee or licensed operator (if any).
- Formally abandoned corridors, including those that are in the process of being formally abandoned.
- Railbanked corridor.

**Active corridors.** The principle function of an active rail corridor is the movement of freight and people by rail. Therefore, rail corridor owners and railroad operators may have little interest in welcoming non-railroad activity onto land that is under their control and supervision. Because corridor lessees and owners are usually self-insured, the railroad industry often bears the burden of litigation for incidents and losses that occur on their property.

However, even when a corridor is in active use for railroad purposes, opportunities for rail-with-trail projects may still exist. Base such projects upon needs that are common to the railway operator and rail-trail developer. Mutual needs might include proactive control of chronic trespassing and vandalism, reduction of fatal and serious accidents and crashes, definition of appropriate grade crossing locations, improved access for maintenance and emergency vehicles, and better control of lateral and physical separation from tracks.

**Inactive corridors that remain under the control of the owner and/or lessee or licensed operator (if any).** Under this scenario, active rail use has been discontinued but the corridor remains under the control of the current owner, lessee or licensed operator (if any). Rails and ties may or may not have been removed, but a formal abandonment process has not been initiated with the Federal Surface Trans-

### *Rail-Trails and Rails-With Trails*

portation Board. Depending on the prospects for future rail business, the controlling interests may allow the corridor to be developed for rail-trail use.

The most important aspect of a railroad corridor is the land and continuity of the corridor.

**Formally abandoned corridors, including those that are in the process of being formally abandoned.** There exist in Vermont some rail corridors that have been abandoned but not railbanked. The Railroad Revitalization and Regulatory Reform Act of 1976 (4-R Act) allows for transfer of abandoned corridors to public use, including for rail-trails.

The existence of private uses on land, which may or may not be public rights-of-way, complicates planning for rail-trail use on such corridors. In some cases, adjacent landowners may have incorrectly perceived that the railroad had abandoned its property interest in the right-of-way. Or the title to these corridors may have been so unclear so as to result in landowners considering or using the corridor as their own property. Where current rail-trail use is desired along abandoned corridors, legal assistance is often needed to research land titles and acquire permanent easements from landowners.

Property agreements for trolley line corridors, however, have proven to be less secure. Nearly all were constructed along easements, which have long since “extinguished” themselves.

**Railbanked corridors.** The development of rail-trails has been greatly facilitated by the railroad corridor preservation tool known as “railbanking.” Where active rail service has been discontinued, railbanking can help preserve the integrity of a railroad right-of-way for future railroad use by preventing the inactive right-of-way from reverting to the ownership of adjacent landowners.

Railbanking allows inactive railroad corridors to be transferred to qualified managers for interim uses, such as rail-trails, provided that the interim use is consistent with future reactivation of railroad service. Until such time as these rights-of-way are needed for future rail service, rail-trail managers may be required to assume all carrying costs (liability, maintenance and taxes) of the rights-of-way. The interim use may be discontinued at any time to accommodate the revitalization of rail service along any railbanked corridor.

#### 6.1.4 Historic References

A significant difference between a rail-trail and a shared use path is the historical background associated with most rail corridors. There is usually ample information that can be obtained from or with the help of railroad enthusiasts, retired railroad employees, people living near the right-of-way, local museums, and state and local historic preservation organizations, and via the Internet.

If the rail corridor is very old, rail service along the corridor may have been operated by more than one railroad. Knowing the name(s) of the company or companies that provided rail service along the line will facilitate research of the history of the line. It may also suggest a name for the rail-trail. Third, using the right terminology lends credibility to the project and can help garner community support.

A wealth of historical information is usually associated with old railroads. Timetables, photographs, advertising, and logos may be available from railroad historians and collectors. The industry itself produced track charts, bridge drawings, engineering data, valuation surveys, employee’s timetables and maps, all of which (if recovered) can build interest and develop a following of rail-trail supporters.

Frequently, physical structures associated with railroad operation remain after rail service has been discontinued. Such structures can be used to recall aspects of prior railroad activity or used to house services that support rail-trail use. Where railroad depots, sheds or other buildings exist, seek the assistance of a preservationist, architect or structural engineer to assess whether such resources should be preserved. These professionals can help determine how much of the original structure remains and whether potential exists for restoring or remodeling the building. Such buildings are sometimes used as museums. Otherwise, they may be adapted to house a restaurant or café, equipment outfitters, public restrooms or lodging.

Old railway structures or the area in which they are located may be designated or have the potential to be designated as historic by the National Register of Historic Places. It is important to consult the State Historic Preservation Office (SHPO) during the planning phase of the project. Any use of federal funds in a transportation project requires review by SHPO to determine if the project could have an adverse effect on historic resources.

Rolling stock that is no longer in active use can often be acquired to further link the corridor to an earlier era of railroading. Where a boxcar, caboos or locomotive is available, mount such equipment on sections of rail supported by ties and ballast. Contact local rail advisory groups for guidance in restoring railroad cars to their original appearance.

Historic mile markers (distance markers) should not be removed, and if recreated, they should follow the historical railroad numbering system. Where rail-trail-based distance markers are desired along a rail-trail facility, they should be added in addition to the railroad markers. Show both types of markers on a rail-trail map.

## 6.2 Design

The design guidelines for rail-trails are similar to shared use paths but tailored to fit the special circumstances found along railroad corridors. The guidelines include:

- User requirements.
- Widths and clearances.
- Pavement sections and surfaces.
- Cross slope and drainage.
- Grades.
- Side slopes, barriers, bridge railing and fencing.
- Design speed, horizontal alignment and stopping sight distance.
- Roadway crossings.
- Managing motor vehicle access.
- Structures.
- Supplemental facilities.
- Security.
- Lighting (refer to Chapter 9).
- Maintenance (refer to Chapter 10).
- Vegetation and Landscaping (refer to Chapter 9).

### 6.2.1 User Requirements

For user requirements of pedestrians, bicyclists, and in-line skaters, refer to Section 5.3.1. The user characteristics of cross country skiers; snowshoers and snowmobilers are discussed below. The season during which these type users may be

**Rail-Trails and Rails-With Trails**

expected on rail-trails where not specifically prohibited generally runs from mid December to early April.

**Cross-Country Skiing**

Rail-trails are popular with cross-country skiers of all ages and abilities. The activity can range from racing, day-touring, and short excursions, to backwoods bushwhacking. Average ski tourers can travel more than 5 km/h (3 mph) in good weather. An advanced skier can travel at 13 km/h (8 mph) or more and may travel 30 km (20 mi) or longer in an outing.

Design bridges wide enough for tracks and poles, and strong enough to support grooming equipment. Railings should be 1.4 m (4 ft 6 in) high to compensate for snow accumulation.

**Snowshoeing**

Most casual snowshoers enjoy loop trails that are up to 5 km (3.1 mi) in length over level to moderate terrain. Ungroomed rail-trails are popular among beginners. Snowshoers can share corridors with other rail-trail users but should be to the side where their tracks do not trample ski tracks.

**Snowmobiling**

Because rail-trails tend to be linear and may extend over great distances, they are attractive to snowmobiling. If snowmobile use is intended or anticipated, consider the guidelines presented in the most recent editions of the Vermont Association of Snow Travelers, Inc. (VAST) *Guide for the Development of Snowmobile Trails* and *Guide for Snowmobile Trail Signing and Placement*.

Well-designed, signed and maintained rail-trails and snowmobile riding areas not only provide enjoyable recreational snowmobiling opportunities but have been proven to significantly reduce the likelihood of a snowmobiler being injured. Statistics indicate that only 10 to 15 percent of snowmobile crashes occur on well maintained and designed rail-trails where as much as 80 to 90 percent of all snowmobile riding takes place.

Vermont Association of Snow Travelers identifies three classes of snowmobile trails. The minimum design parameters for snowmobile trails (including width, vertical clearance and live loads) are based on the type of grooming operations anticipated as shown in Table 6-1.

**Table 6-1.**  
Snowmobile Trail Classes

Class	Width		Clear Zone (per side)	Vertical Clearance	Groomer	
	Preferred	Min.			Width	Weight
1	4.3 m (14 ft)	3.6 m (12 ft)	0.6 m (2 ft)	3.6 m (12 ft)	2.4 m (8 ft)	3.6 tonne (4 ton)
2	3.6 m (12 ft)	3.0 m (10 ft)	0.6 m (2 ft)	3.0 m (10 ft)	2.0 m (6 ft)	1.8 tonne (2 ton)
3	3.0 m (10 ft)	2.4 m (8 ft)	0.6 m (2 ft)	2.4 m (8 ft)	1.2 m (4 ft)	0.9 tonne (1 ton)

Source: *Guide for the Development of Snowmobile Trails* and *Guide for Snowmobile Trail Signing and Placement* (VAST).

Greater trail width may be required on curves than for straight sections. For example, a power groomer unit 2.4 m (8 ft) wide requires a trail tread width of 5.7 m (19 ft) to negotiate a 7.5 m (25 ft) inside turning radius (the recommended minimum). Where the groomer design speed of a trail is higher than 15 km/h (10 mph), or where steeper cross slopes exist, provide additional trail width.

St. Albans



Rail-trails are popular with cross-country skiers of all ages and abilities.



The minimum design parameters for snowmobile trails (including width, vertical clearance and live loads) are based on the type of grooming operations anticipated.



**Managing Winter Rail-Trail Conflicts**

While winter rail-trail users are generally considerate of one another, the speed differential between snowmobiles, skiers and snowshoes can cause conflicts. Where problems are anticipated or later develop, rail-trails lend themselves to being segmented according to user types (i.e., outlying sections of a rail trail could be assigned to snowmobile use, while sections closer to populated areas could be designated for snowshoe and cross country ski use). Further, some sections of the rail-trail might be groomed while other sections remain ungroomed. Speed regulation and enforcement can also help to mitigate conflicts between users. The state established speed limit on state owned rail-trails is 55 km/h (35 mph). Perhaps the single most important safety feature for multi-use of rail-trails is good sight distance.

**6.2.2 Widths and Clearances**

The widths and clearances as specified for shared use paths (refer to Section 5.3.2) also apply for rail-trails and rails-with-trails. Because rail trails are often used by equestrians and snowmobiles, the greater vertical clearances required for those uses often apply. Snowmobile grooming equipment normally requires 3.0 m (10 ft) and equestrian use requires 3.6 m (12 ft). See also VTrans Standard Drawing A-78M, Shared Use Path Typical and VTrans Standard Drawing, Rail-Trail Typical.

**Strategies for Sub-Optimal Rail-Trail Widths**

Where adequate widths and clearances cannot be attained, as may be the case where rail corridor berms are extremely narrow or where minimum clearance from an active rail line must be maintained, consider the options illustrated in Figures 6-1 through 6-6:

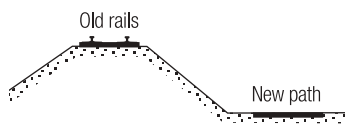

**Figure 6-1.**  
Locate Path at the Bottom of a Slope.

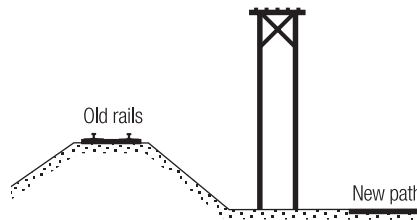

**Figure 6-2.**  
Use an Adjacent Utility Corridor.

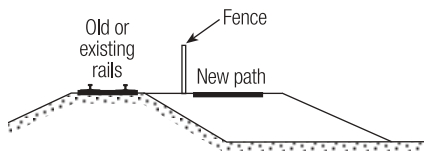

**Figure 6-3.**  
Widen the Berm.

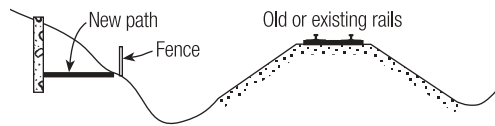

**Figure 6-4.**  
Excavate the Slope and Buttress with a Retaining Wall.

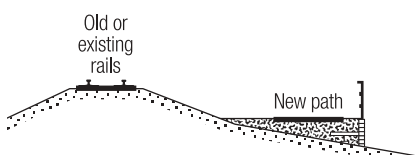

**Figure 6-5.**  
Use a Low Retaining Wall to Increase the Width.

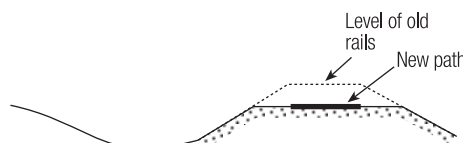

**Figure 6-6.**  
Excavate the Top of the Berm.

**Rail-Trails and Rails-With Trails**

Confluence, PA



Where creating extra width is not an option, it may be possible to proceed with the rail-trail design by restricting uses that require wide tread areas or designing for uses that require less width (i.e., unpaved shared-use path, or narrower ski or snowmobile trails).

Where creating extra width is not an option, it may be possible to proceed with the rail-trail design by restricting uses that require wide tread areas or designing for uses that require less width (i.e., unpaved shared-use path, or narrower ski or snowmobile trails). Table 6-5 shows the uses that can be accommodated on narrow rail-trails. A more primitive rail-trail that features narrow path widths, natural surfaces, and few or no amenities will also attract fewer rail-trail users than a facility that is highly developed.

**Table 6-2.**  
Designing for Low Levels of Use on Narrow Rail-Trails.

Available corridor width	Recommended uses*	Shoulder width	Minimum width for bikes and peds	Total
3.6 m (12 ft)	Paved shared use path and Class 1 snowmobile trail	0.6 m (2 ft)	2.4 m (8 ft)	3.6 m (12 ft)
3.0-3.6 m (10-12 ft)	Unpaved shared use path and Class 2 snowmobile trail	0.6 m (2 ft)	1.8 m (6 ft)	3.0m (10 ft)

\* Although a snowmobile trail requires an overall clear width of 4.2 m (12 ft) to 4.8 m (16 ft), depending on the class, trail grooming can result in a build-up of packed snow on both sides of the trail tread area at filled slopes providing a satisfactory usable width in excess of the available corridor width as would be otherwise measured during non-snow conditions. In any case, maintain the overall clear width recommended for each class of snowmobile trail (i.e., minimum clear zone on each side of the trail plus the trail tread area).

**Setback and Separation (Rails-with-Trails)**

Except as later specified for at-grade railroad crossings in this chapter, separate rail-with-trail improvements (i.e., fences, signs, landscaping, pathways, or other features) from the outside face of the nearest rail of an active railroad track. Where no structures, including fences, occur along the side of a pathway, the edge of the pathway may be as close as 3.3 m (11 ft) from the outside rail where space is at a premium, such as may occur at an undercrossing.

According to FHWA's *Rails-with-Trail: Best Practices Report (2001)* for rail-with-trail corridors, the minimum setback distance should take into consideration the speed and frequency of trains in the corridor, maintenance requirements, separation techniques, existing problem areas and good engineering judgment. However, when adequate setback widths can be achieved along the majority of a corridor and where physical constraints will not allow for the desired setback width, safety should not be compromised. Instead, additional barriers should be considered or additional right-of-way purchased.

At an absolute minimum the setback must keep rail-trail users outside the “dynamic envelope”, or operating space, of the train. According to the MUTCD, the dynamic envelope is “the clearance required for the train and its cargo to overhang due to any combination of loading, lateral motion or suspension failure”. The dynamic envelope includes the area swept by a turning train.

The recommended minimum rail-with-trail setbacks are shown in Table 6-3 and Figures 6-7A and 6-7B. Exceptions to the recommended setback between a rail-with-trail and track centerlines may be acceptable to the railroad operator or property owner. However, such variations should be negotiated on a case-by-case basis with all affected parties. These possible exceptions are in constrained areas and should only be applied along relatively low speed and volume rail lines.



**Separation** refers to the space between the edge of improvements associated with a path to the nearest rail face of an adjacent active rail line.

**Setback** refers to the distance from centerline of the nearest active rail line to the edge of path improvements (e.g., signs, fencing or shoulder of a path).

**Table 6-3.**  
**Minimum Separation from Active Rail Line**

<b>High density/high speed lines:</b> (11 or more trains per day; maximum speed over 72 km/h (45 m/h))	Recommended: 7.6 m (25 ft) or more, with fence or other separation technique Minimum: 4.6 m (15 ft), with solid-type barrier
In constrained areas, e.g., cut/fill, bridges, trestles	Minimum: 4.6 M (15 ft), with fence or other separation technique
With vertical separation or 3 m (10 ft)	Minimum: 6 m (20 ft)
<b>Medium density/medium speed lines:</b> (less than 11 trains per day; maximum speed 72 km/h (45 m/h))	Recommended: 7.6 m (25 ft) or more, Minimum: 4.6 m (15 ft), with adequate separation technique
In constrained areas, e.g. cut/fill, bridges, trestles	Minimum: 3.3 m (11 ft), with fence or other separation technique
Extensive history of trespassing (>100 persons per day)	Minimum: 3.3 m (11 ft), with fence or other separation technique
<b>Low density/low speed branchlines:</b> (less than one train per day; maximum speed 56 k/h (35 m/h))	Recommended: 7.5 m (25 ft) or more Minimum: 3.3 m (11 ft) (RWT to serve as maintenance access)
In constrained areas, e.g., cut/fill, bridges, trestles	Minimum: 3.3 m (11 ft), with fence or other separation technique

Source: *Rail-with-Trails: Lessons Learned – Draft*; Table 5.2 Minimum Setbacks with modifications by VTrans Rail Division.

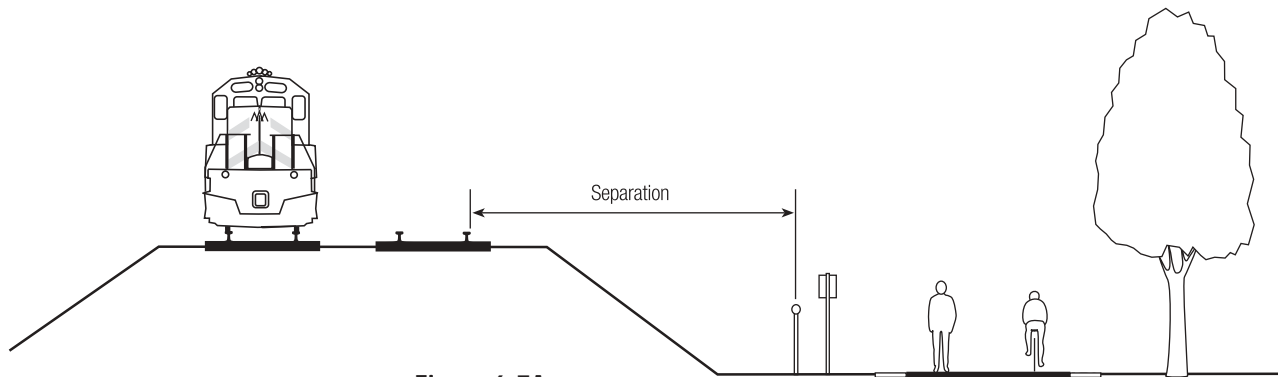

**Figure 6-7A.**  
**Separation, Rails-With-Trails.**

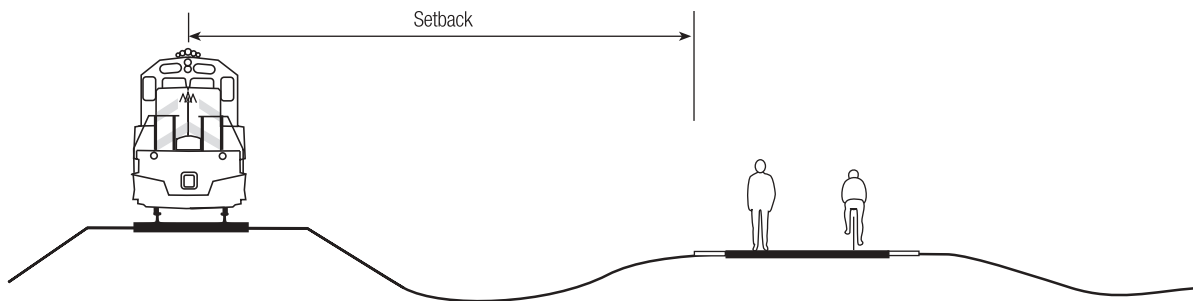

**Figure 6-7B.**  
**Setback, Rails-With-Trails.**

*Rail-Trails and Rails-With Trails***6.2.3 Pavement Sections and Surfaces**

Except as discussed below, the pavement sections and surfaces as specified for shared use paths (refer to Section 5.3.3) also apply for rail-trails. As with shared use paths, the surface of a rail trail must comply with ADAAG requirements that it be firm, stable and slip-resistant. VTrans has developed a specification (as shown in Table 6-4) for unpaved surfaces that meet this requirement. See also VTrans Standard Drawing, Rail-Trail Typical.

Sieve Designation (Metric)	Sieve Designation (English)	Percentage by mass (weight) passing square mesh sieves
9.5 mm	3/8 inch	80-100
4.75 mm	#4	60-90
1.18 mm	#16	20-40
600 $\mu$	#30	14-30
300 $\mu$	#50	10-25
150 $\mu$	#100	8-15
75 $\mu$	#200	0-8

Ohio, PA



If track and ties have been removed, a sub base of ballast, and in some cases a sub-ballast layer of cinders, may still remain above a sub grade of natural soil or compacted fill.

**Railroad Beds**

Railroads beds were constructed to support loads as heavy as 13.6 ton (30,000 lb) per train wheel traveling at 50 mph. Obviously, design loads for rail-trail use will be significantly lighter — on the order of 10,000 lb per gross vehicle weight traveling at 15 mph for heavy maintenance and emergency vehicles.

**When the Tracks and Ties have been Removed**

If track and ties have been removed, a sub base of ballast, and in some cases a sub-ballast layer of cinders, may still remain above a sub grade of natural soil or compacted fill.

A common question relating to ballast is should it be kept in place, or should some or all of it be removed? The answer depends on a number of factors, which include:

- Has the corridor been railbanked for possible return to future railroad use?
- Will toxic substances be uncovered if the ballast is disturbed?
- Have cross-ties left their imprint (“track-tie memory”) in the ballast?
- Do drainage problems exist at the sub base or sub grade levels?

To answer these and other questions, the expertise of a structural or geotechnical engineer may be required.

Where possible, it is generally a good idea to leave as much as the ballast in place to disperse the weight of the rail-trail’s wearing surface and to promote drainage. A minimum of 200 mm (8 in) of ballast used as sub-base is recommended. If track-tie memory is an issue, remove the top layer of ballast and regrade, recompact and reconstruct the remaining ballast to an elevation that can support the rail-trail’s design load. Retain excess clean ballast, preferably at the construction site for reuse as needed for either construction or maintenance.

**When the Tracks and Cross-ties Remain**

The preferred technique that has been used in Vermont is to bring in fill sufficient enough to cover over the ties and rails. See Figure 6-8. This technique should be viewed as a short-term stopgap measure only. The major disadvantage of this approach is that the rail-trail is more prone to washouts and exposure of the under-

lying rails and ties can create a hazard for rail-trail users and will require additional maintenance. However, such a compromise may be necessary to obtain local and political support for development of a rail-trail. It should be noted that any remedy that calls for filling in and around the ties and rails will accelerate the deterioration of the ties and rails. The maintenance costs and benefits should be fully weighted before selecting either of these options.



**Figure 6-8.**  
Creating a Temporary Pedestrian Path when Cross-ties and Rails Remain

### Geotextiles

Consider the use of geotextiles (fabric mats that increase the stability of subsurface materials) in rail trail construction. For aggregate surface rail trails, place the geotextile between the sub base and the surface course. For paved rail trails, place the geotextile between the sub grade and the sub base if this is a practical alternative. Geotextile can help control vegetation on unpaved rail-trails and prevents the surface material from migrating down into the ballast and prevents the ballast from migrating up to the surface of the rail-trail.

### 6.2.4 Grades

Because the grades of a railroad corridor rarely exceed 2.5 percent (1:40), the grade requirements of ADA and as specified for shared use paths should be easily met. However, grades may be an issue when providing access from locations adjacent to rail-trail facilities. In such cases, follow the recommendations for shared use paths (refer to Section 5.3.4).

### 6.2.5 Cross Slope and Drainage

The recommendation for cross slope and drainage as specified for shared use paths (refer to Section 5.3.5) also apply for rail-trails. See VTrans Standard Drawing, Rail-Trail Typical.

### 6.2.6 Side Slopes, Bridge Railings, Barriers and Fencing

One main difference between shared use paths and rail trails is that the supporting structure of fill and ballast usually exists on a rail bed prior to its development as a trail. It is often impractical and costly to add material to existing railroad bed fill slopes. Additionally, many rail lines traverse rural, vegetated areas with native vegetation growing along the sides of the rail bed. This results in trails that meet minimum path widths, but often lack preferred shoulder and lateral clearance widths. Steeper than 1:3 side slopes are often present, however many rail trail are unpaved, resulting in slower user speeds. Existing vegetation and the presence of recovery areas between the edge of the path and the top of slope may eliminate the need for barriers in many cases.

The side slopes, bridge railings, barriers and fencing as specified for shared use paths (refer to Section 5.3.6) also apply for rail-trails. Pay particular attention to guidelines for recovery areas for unpaved paths as shown in Table 5-2. See also VTrans Standard Drawing, Rail-Trail Typical.

#### Sub-Optimal Side Slope

Where steep side slopes are encountered and the minimum requirements for recovery areas described for shared use paths cannot be attained (refer to Section

**Rail-Trails and Rails-With Trails**

5.3.2 and 5.3.6), consider the following options:

- Use more forgiving materials (e.g., vegetation and grass) along steep side slopes.
- Provide landscaping along the slopes of the berm to limit the extent of accidental falls.
- Eliminate the need for a railing or barrier (e.g., move the path to bottom of slope or widen berm).
- Install warning signs and pavement markings.
- Use a combination of these techniques.

**Special Considerations for Barriers on Rails-with-Trails**

The primary objective of a barrier between a rail-trail and active rail line is to separate and channelize users to existing or new formal grade or grade-separated crossings. Occasional breaks in such a barrier are provided for environmental requirements, safety and access. Depending on the level of separation required, barriers typically consist of fencing, vegetation, grade or ditches.

Because the development of a rail-with-trail may impact railroad operation, the barrier type, material and location should be determined jointly among the interested parties. According to *FHWA Rails-with-Trail: Lessons Learned (2002)* over 70 percent of existing rail-with-trails in the United States are separated from tracks by some kind of barrier, including fencing (34 percent), vegetation (21 percent), grade (16 percent), or drainage ditch (12 percent). The fencing style varies from chain link, woven wire mesh, wrought iron, vinyl, and steel picket to wooden rail.

**Vegetation, grades and ditches.** Vegetation, grades and ditches may be used as a barrier between the rail-trail and an active track when:

- The rail-trail (not including shoulder) is located farther than 7.6m (25 ft) from the nearest rail face, or
- The vertical separation between the surface of the rail-trail and the track is greater than 3 m (10 ft).

**6.2.7 Design Speed, Horizontal Alignment and Stopping Sight Distance**

The design speeds, horizontal alignment and stopping sight distance specified for shared use paths (refer to Section 5.3.7) also apply for rail-trails. These requirements should be easy to meet for rail-trails that occupy rail corridors.

**6.2.8 Crossings****Roadway Crossings**

The recommended treatments for roadway crossings as described for shared use paths (refer to Section 5.3.8) also apply to rail-trails.

When an at-grade rail-trail crossing intersects a roadway less than 105 m (350 ft) from a highway intersection, consideration should be given to diverting the crossing to the highway intersection and treat it as a parallel path crossing or pedestrian crossing. However, this may not be possible if the area between the crossing and intersection is heavily developed, as in a village or urban area.

**Agricultural Crossings and Private Access**

A thorough analysis of land records and valuation sheets will likely reveal where adjacent landowners have a legal right to cross a railroad corridor, even after railroad service has been discontinued. The principle design issues are:

- Ensuring that access for the landowner is perpetuated throughout the year (including winter).

- Safety of rail-trail users.
- Assuring convenience for adjacent landowners.
- Discouraging trespassers.
- Assigning responsibility for rail-trail maintenance.

**Agricultural crossings.** Farm crossings usually involve the movement of livestock and equipment from one side of the rail-trail corridor to the other. Therefore, it may be necessary to provide a way to guide livestock across the rail-trail while preventing escape along the rail-trail. A simple fence and gate arrangement (as shown in Figure 6-9) can be provided to accomplish both objectives as long as the gates are capable of operating without difficulty even during winter conditions. Pave the rail-trail crossing with asphalt for the full width of the crossing. Do not use cattle guards on or near any part of the rail-trail surface. Also, special attention should be given to keeping the rail-trail clear of debris and manure.

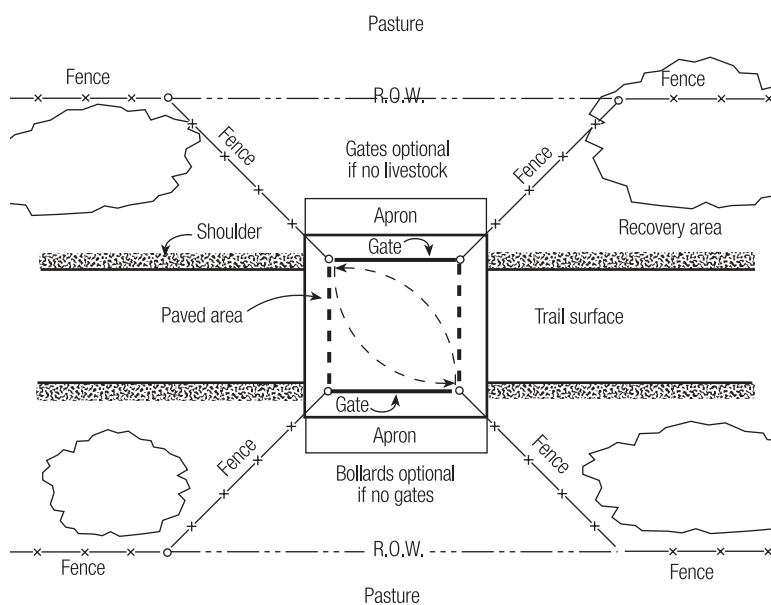

**Figure 6-9.**  
Agricultural crossing.

**Private access.** The only way to access some camps, vacation homes, full-time residences and businesses is by crossing a rail-trail corridor. For the property owner, trespassing by rail-trail users may be a concern. For the rail-trail user, damage to the travel surface or accumulation of excess gravel can be an issue. “No trespassing signs” and notices in rail-trail literature can help remind rail-trail users not to trespass.

The responsibility for providing and installing “no trespassing” signs should be a part of an access agreement between the rail-trail management entity and the individual landowner. To maintain uniformity in signs, the rail-trail manager may be willing to accept the responsibility for providing and installing the signs in exchange for the property owner keeping the rail-trail clear of excess gravel and stones. Where cross traffic creates a chronic maintenance problem, consider paving the crossing with asphalt.

### 6.2.9 Managing Motor Vehicle Access

The recommended treatments for managing unauthorized motor vehicle access as described for shared use paths (refer to Section 5.3.9) also apply to rail-trails.

*Rail-Trails and Rails-With Trails***6.2.10 Structures****Bridges**

The recommended treatments for bridges, railings and approaches as described for shared use paths (refer to Section 5.3.10) also apply to rail-trails. However, consider the following special conditions.

**Existing bridges.** A structural engineer should evaluate existing railroad bridges for structural integrity to ensure they are capable of carrying the appropriate design loads. The standard practice for path bridges is to design for H-10 loading.

If bridge abutments or piers have been subjected to flowing water during their lifetime, a bridge scour analysis may also be necessary.

An historic preservation specialist should assess whether the bridge has historic or architectural significance.

If the bridge lacks decking suitable for rail-trail use, new decking capable of supporting the design load must be installed. Where decking is used, it should be laid transversely across the bridge (90 degrees to the direction of bicycle travel) to avoid joints that may trap a bicycle wheel.

Provide gaps of 3-6 mm (0.125-0.25 in.) between decking members to allow for drainage. Where snowmobile use is expected or permitted, temporary seasonal plank runners may be laid over the permanent deck to protect it from the metal cleats commonly found on snowmobile tracks. Where used, the runners should be laid parallel to the path of travel of the snowmobiles as shown in Figure 6-10.

Because runners can interfere with cross-country skiers, the management plan for operation of the rail-trail should include a plan to resolve user conflicts early on. Plank runners should be promptly removed in the spring.

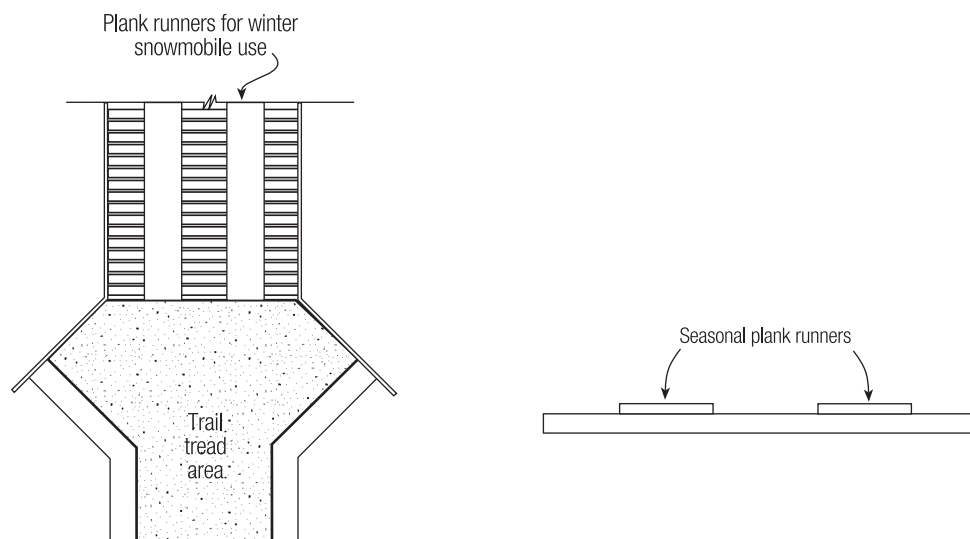

**Figure 6-10.**  
Seasonal Plank Runners.

**Adapting historic bridges for reuse.** VTrans operates an Adaptive Use Bridge Program as a part of their Historic Bridge Program. The purpose of the Adaptive Use Program is to preserve, restore, relocate and reuse historic bridges. The success of the program depends upon a viable system for preserving bridges that can no



longer serve highway uses at their existing locations. To meet this need, qualifying bridges are adapted to alternative transportation uses at their existing sites or will be relocated for alternative transportation uses such as pedestrian and bicycle paths, snowmobile trails, recreational sites, or historic sites.

Where reuse of an historic bridge appears feasible, consult the VTrans Adaptive Use Bridge Program manual for information about (a) methods for identifying and selecting new sites for historic bridges; (b) preparation of rehabilitation plans; (c) development of contracts for different aspects of each project; (d) cleaning and painting bridges; (e) names of contractors qualified to perform work; (f) coordination regarding materials and labor supplied by the Vermont Department of Corrections; (g) archival documentation; and other appropriate details.

**New bridges.** If old bridges have been removed, it may be possible to utilize existing abutments and piers (if any) to support a new structure. Again, a structural engineer should evaluate the structural integrity of any remaining supports and a scour analysis should be performed (where applicable) to ensure that the piers and abutments are capable of carrying the appropriate design loads.

Where no previous supports remain, a new bridge will have to be provided. The first choice should be to determine whether an adaptive use bridge, no longer suitable to carry modern highway traffic, is available, possibly from the inventory of previously stockpiled bridges. Designed to carry heavier loads than may be required for the rail-trail (notwithstanding use by maintenance and emergency vehicles), adaptive use bridges may cost less to refurbish than it would cost to erect a new bridge. Also, adaptive use bridges are likely to be more in keeping with the historical context of the railroad corridor.

If a new bridge must be considered, the type of superstructure to be used will depend on specific site conditions including: whether a waterway, roadway or railway will be bridged; the length of span required; and access to the construction site. Refer to Section 5.3.10, Shared Use Paths for a complete discussion of design consideration for structures.

As a general rule, the following types of structures, based on spans, have proven successful in other areas.

- 0 to 4.5 m (0 to 15 ft): Consider single span, treated timber structures, using standard dimension lumber, with timber crib abutments.
- 4.5 to 10.7 m (15 to 35 ft): Consider multiple span, treated timber structures, using standard dimension lumber or laminated timber superstructure components with timber crib or timber pile bent substructures.
- 10.7 to 27.4 m (35 to 90 ft): Consider prefabricated metal superstructures, or steel or prestressed concrete girders with timber or concrete decks, reinforced concrete on spread footings or piles.
- 27.4 m (90 ft) or more: Consider prefabricated metal superstructures and reinforced concrete on spread footings or piles.

**Overpasses and underpasses.** The recommended treatments for overpasses and underpasses as described for shared use paths (refer to Section 5.3.10) also apply to rail-trails. Where a rail corridor has been railbanked, preserve a vertical clearance as required for railroad operation: 7 m (23 ft) above the top of the highest rail.

Where an existing railroad bridge has been removed, another approach is to use a corrugated metal culvert and backfilled material to support the rail-trail while providing access under the rail-trail.

**Rail-Trails and Rails-With Trails****6.2.11 Supplemental Facilities and Amenities**

To enable a rail-trail to develop to its full potential, consider a broad range of support facilities (refer to Section 5.3.11). The extent to which these facilities are made available depends on:

- Rail-trail setting and uses.
- Intensity of use.
- Maintenance.
- Utilities and infrastructure required.

Refer to Section 9, Landscaping and Amenities, for a discussion of supplemental facilities and other amenities.

**6.3 Additional Resources**

Users of this manual are encouraged to consult the following resources for the broadest coverage of issues relating to the planning and design of rail-trails and rails-with-trails.

- *Guide for the Development of Bicycle Facilities*, American Association of State Highway and Transportation Officials (AASHTO), Washington, DC. 1999.
- *Guide for the Development of Snowmobile Trails*, Vermont Association of Snow Travelers, Inc. 2000-2001.
- *Guide for Snowmobile Trail Signing and Placement*, Vermont Association of Snow Travelers, Inc. 2000-2001.
- *Designing Sidewalks and Trails for Access: Best Practices Design Guide*, Federal Highway Administration (FHWA), 2001.
- *Manual for Railway Engineering*, American Railway Engineering and Maintenance-of-Way Association, 8201 Corporate Drive, Suite 1125, Landover, MD 20785, Phone: 301-459-3200, Fax: 301-459-8077, www.arena.org. 2001.
- *Rail-trails and Liability*, Rails-to-Trails Conservancy, 1100 Seventeenth Street, NW, Washington, DC 20036, Phone: 202-331-9696, Fax: 202-331-9680, www.railtrails.org. 2000.
- *Rails-with-Trails*, Rails-to-Trails Conservancy, 1100 Seventeenth Street, NW, Washington, DC 20036, Phone: 202-331-9696, Fax: 202-331-9680, www.railtrails.org. 2000.
- *Rails-with-Trails: Best Practices Report*, Federal Highway Administration (FHWA), 2001.
- *Rails with Trails: Design, Management and Operation Characteristics of 61 Trails along Active Railroads*, November 2000, Rails-to-Trails Conservancy.
- *Trails for the Twenty-First Century*, Rails-to-Trails Conservancy, 10<sup>th</sup> floor, 1100 Seventeenth Street, NW, Washington, DC 20036, Phone: 202-331-9696, Fax: 202-331-9680, www.railtrails.org. 2001.

Ohio, PA



Rail-trail amenities — like this bird feeder — provide opportunities to acquaint users with flora and fauna of the area.

Confluence, PA



Rail-trails can provide access to natural areas for activities unrelated to walking or bicycling. This stairway allows anglers to reach a popular fishing hole.

CHAPTER 7:



# Traffic Calming

## *Contents*

7.1 Introduction .....	7-2
7.1.1 Toolbox of Traffic Calming and Supporting Measures for Vermont .....	7-2
7.1.2 Benefits of Calming Traffic .....	7-3
7.1.3 Application .....	7-4
7.1.4 Applicable Guidelines and Standards .....	7-4
7.2 Design .....	7-5
7.2.1 Adopt a Broad Approach .....	7-5
7.2.2 Traffic Calming Measures .....	7-7
7.2.3 Minimizing Impacts on Pedestrians and Bicyclists .....	7-9
7.2.4 Roundabouts .....	7-13
7.3 Additional Resources .....	7-16

## *Figures*

7-1 Village Concept with Gateways .....	7-5
7-2 Chicane .....	7-7
7-3 Curb Extensions .....	7-8
7-4 Lane Reductions .....	7-8
7-5 Raised Median .....	7-8
7-6 Speed Table .....	7-8
7-7 All-Way Stop Signs .....	7-9
7-8 Maintain Walkway Continuity at Splitter Islands .....	7-9
7-9 Maintain Bikeway Continuity at Curb Extensions .....	7-10
7-10 Provide Shared Use Paths to Accommodate Pedestrians and Bicyclists .....	7-10
7-11 Ensure Access at Medians .....	7-11
7-12 Provide a Passageway at Cul-de-sacs .....	7-11
7-13 Provide a Passageway at Medians .....	7-12
7-14 Use a Combination of Measures to Produce the Desired Effect .....	7-12
7-15 Maintain Operating Width of the Bikeway Up to the Yield Line .....	7-14
7-16 Use Textured and Colored Crosswalks at Crossings and Islands .....	7-16

## *Tables*

7-1 Traffic Calming Measures .....	7-6
------------------------------------	-----



## 7.1 Introduction

This chapter discusses roadway design elements and techniques that can be used to reduce the speed or volume of traffic to levels consistent with road function. In addition to the more widely known traffic calming measures, supporting techniques that raise driver awareness and otherwise improve streets for pedestrians and bicyclists are also covered. Traffic calming is a diverse and rapidly evolving field. It blends engineering, planning and urban design to minimize adverse effects of motor vehicle speed and volume.

VTrans has developed a “Traffic Calming Study and Approval Process for State Highways” as well as a series of standard drawings depicting design details for different traffic calming devices. The intent of this chapter is to give a broad overview of traffic calming and to discuss its interaction with the planning and design of bicycle and pedestrian facilities. When considering the installation of traffic calming devices on state highways, it is necessary to refer to the VTrans approval process and Standard Drawings in addition to this manual.

Developer David Sucher wrote in *City Comforts* (Seattle, 1995): “Traffic calming is a set of techniques of street design. It involves a variety of small modifications to street geometry and dimensions to accommodate the automobile and to give the pedestrian psychological precedence....”

The Institute of Transportation Engineers (ITE) defines traffic calming as “a combination of mainly physical measures that reduce the negative impacts of motor vehicle use, alter driver behavior and improve conditions for non-motorized street users.”

However traffic calming is defined, the key from a pedestrian’s and bicyclist’s point of view is who benefits — especially residents, pedestrians, bicyclists, and businesses — from measures that increase safety, slow traffic, reduce volume and improve the roadway environment.

### 7.1.1 Toolbox of Traffic Calming and Supporting Measures for Vermont

There are many measures that involve making physical changes to the built environment to reduce traffic speed and volume. Typically, each measure is designed to perform a specialized function:

- *Measures that change the horizontal alignment of the roadway* include chicanes, raised medians, roundabouts and traffic circles.
- *Measures that change the vertical alignment of the roadway* include raised intersections, speed humps and speed tables.
- *Measures that narrow the travel lane or roadway either physically or psychologically* include neck downs, curb extensions, curb radius reductions, gateway treatments, landscaping treatments, lane width reductions, raised medians, on-street parking, pavement texture treatments and pavement markings and delineation.
- *Measures that divert or block travel* include cul de sacs and partial closures.
- *Measures that regulate and enforce movements* include 4-way stops, signed turning restrictions, truck restrictions and speed readers.
- *Measures that reduce the need to travel* (refer to Chapter 2, Planning for Pedestrians and Bicycles) include good land use planning, traditional neighborhood development and travel demand management.

#### Some Traffic Calming Terms

**Action:** activity that helps calm a roadway (such as intense enforcement).

**Calm:** decrease automobile impacts to return a roadway to its intended function.

**Device:** physical feature of a roadway that helps calm it.

**Measure:** a device, regulation or action that helps calm a roadway. Synonyms: technique, tool, treatment.

**Regulation:** a prescribed traffic rule (such as no right turn on red).

### 7.1.2 Benefits of Calming Traffic

Traffic calming programs can help to:

- Increase the comfort and security for non-motorized street users thereby improving safety and making streets more attractive for bicyclists and pedestrians.
- Reduce conflicts between highway users including pedestrians, bicyclists, public transit, freight carriers, and motorists.
- Balance access and mobility for all highway users, including pedestrians and bicyclists.
- Reduce vehicle-related conditions that adversely affect the environment including traffic congestion, air pollution, accidents, and noise.
- Enhance the aesthetics of highway corridors.
- Preserve the historic character of villages, towns and neighborhoods.
- Increase neighborhood interaction.
- Increase economic vitality and property values.

Some of these benefits can be difficult to measure or may take a long time to become evident. Usually, though, individual projects will demonstrate one or more of the following benefits.

#### Slowing Traffic Speed

The principle objective of traffic calming is to slow traffic speed. Speed studies are almost always performed when traffic calming is applied to existing streets. The most important components to be investigated are range and frequency of speed being experienced in the problem area. These factors may be evaluated according to:

- 85<sup>th</sup> percentile speed. This is the speed which 85 percent of the traffic is traveling at or below.
- Top speed and range. Helps determine how extreme the speed problem is.
- 10 mph pace speed. Indicates the 10 mph range with the highest frequency of occurrences and the percent of observations in the pace. Also helps identify behavior of the greatest number of drivers and level of variation among vehicles.

Speed studies can also help determine the time of day, day of week, and direction of speed problems. Where speeding problems are concentrated or focused, enforcement may correct the problem. Where speed problems are ongoing, irregular or diffuse, traffic calming techniques may be more effective.

#### Reducing Traffic Volume

Another objective of traffic calming on local streets is to reduce traffic volume by discouraging cut-through traffic. Traffic volume can be reduced by making physical changes to the roadway that either discourages cut-through traffic or causes drivers to look for other routes. The physical changes to achieve these results include: adjusting the horizontal or vertical alignment of the roadway; narrowing the roadway; and diverting or closing the roadway to through traffic. Often, these techniques are used to increase pedestrian safety and enhance the quality of life in residential neighborhoods (see below).

#### Increasing Safety

Traffic calming can help to reduce the likelihood and lessen the severity of motor vehicle crashes with pedestrians and bicyclists. When a person is struck by a motor vehicle, they have an 85 percent chance of being killed when the motor vehicle is traveling at 40 mph, a 45 percent chance of death at 30 mph, and only a 15 percent

rate of mortality at 20 mph (Killing Speed and Saving Lives, UK DOT). Refer also to Section 3.2.2, Pedestrian Crashes.

As a planning and design tool for bicycle and pedestrian facilities, certain traffic calming measures have been shown to substantially contribute to reductions in the severity of bicycle and pedestrian crashes. German studies have shown that the number of fatalities involving pedestrian and bicycle crashes with motor vehicles decreased by almost 50 percent in experimental zones where the average speed was reduced from 50 km/h to 30 km/h (31 mph to 19 mph). Further, injuries and air pollution were also significantly decreased.

It is important to note, however, that not all traffic calming measures lead to safer conditions for all users. For example, vertical deflection in the roadway can harm drivers with certain physical disabilities and horizontal deflection can be problematic for drivers who are unfamiliar with traffic calming devices

### **Improving the Roadway Environment**

As more and more traffic calming tools are implemented across the nation, it is becoming apparent that the most effective traffic calming efforts include a “complete package” of design and landscaping features. Visual breaks in the streetscape add interest and help minimize the “raceway” appearance of streets and roads. Slower, smoother traffic flow can reduce noise, air pollution and congestion. The net result is an improvement in neighborhood aesthetics and livability.

#### **7.1.3 Application**

On existing roads and highways, measures to calm traffic may be appropriate wherever there are undesirable speeds, volumes, or conflicts. On new or reconstructed facilities, traffic calming measures can be integrated into the design to achieve reduced speeds and better pedestrian orientation.

Throughout the state, many small towns and villages are linked by major highways and thoroughfares that go through the center of town. Many of these roads are “Main Streets” with on-street parking, sidewalks, commercial blocks, and public squares. Others are residential streets with generous building setbacks, yards and continuous street trees. These historic areas may be only a few blocks in length but are the heart of their community and should be protected from excessive traffic. Creative use of traffic calming can help balance the conflicts between through traffic and local access.

In urban residential neighborhoods, traffic calming is often used to control speeds and cut-through traffic on local streets. In this context, traffic calming is an area-wide treatment rather than a solution for one or two problem streets.

Consider the following issues for all traffic calming applications:

- Characteristics and function of the street.
- Objectives of the proposed traffic calming effort.
- Physical limitations imposed by the traffic calming technique.
- Effect on other streets.
- Effect on emergency equipment and response times.

#### **7.1.4 Applicable Guidelines and Standards**

This chapter does not include engineering specifications for traffic calming measures or design details unrelated to bicycle and pedestrian considerations. For this guidance, refer to the following VTrans Standard Drawings:

**VTrans Standard Drawings that Apply to Traffic Calming**

Traffic Calming Measure	VTrans Standard Drawing
Traffic calming matrix .....	TC-0
Speed hump .....	TC-1M
Speed table .....	TC-2M
Chicane .....	TC-3M
Neck down .....	TC-4M
Traffic circle.....	TC-5M
Raised intersection .....	TC-6M
Curb extension .....	TC-7M
Median .....	TC-8M
Roundabout .....	TC-9AM
Mini-roundabout.....	TC-9BM
Village design treatments (mid block group) .....	TC-10M
Village design treatments (intersection group).....	TC-11M
Village design treatments (median group) .....	TC-12M
Village concept with gateways.....	TC-13M
Landscaping treatment details.....	LS-1M
Pavement marking .....	See TC-0
Delineation .....	See TC-0
On-street parking .....	See TC-0
Speed reader (permanent).....	See TC-0

## 7.2 Design

### 7.2.1 Adopt a Broad Approach

Use a combination of measures (including physical improvements, intersection and traffic control devices, and other measures) throughout an area to achieve the greatest effect. See Figure 7-1.

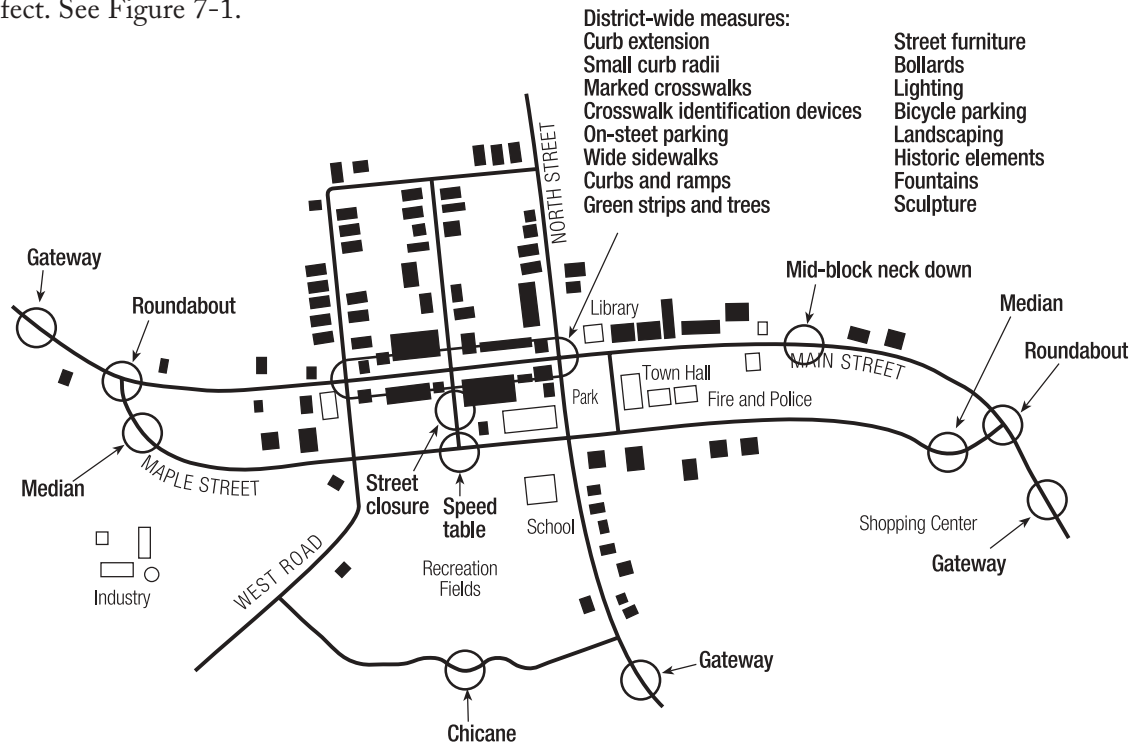

**Figure 7-1.**  
 Village Concept with Gateways.  
 A variety of measures is often more effective than a single type of device.

**Table 7-1.**  
**Traffic Calming Measures.**  
**Physical Improvements**

Measure	Description	Considerations
Speed humps (TC-1)	Raised sections of pavement positioned across streets to slow traffic. Speed reduction is achieved by vertical displacement of vehicles.	Most effective when used in a series rather than alone. Hump should extend across path of bicycle travel without a side slope within the travel lane.
Speed tables (TC-2)	Flat-topped speed humps that can be designed as pedestrian crossings.	Should not be used on critical emergency response routes or bus routes.
Chicanes (TC-3)	Deviations along an extended length of a street created by installation of offset curb extensions. The result is a non-linear path of travel for vehicles.	Useful where speed control is desired over a longer area.
Neckdowns (TC-4)	Curb extensions at a non-intersection location.	Maintain lane width for motor vehicles and bicycles along length of curb extension. Engineer drainage carefully. Often used in conjunction with a mid-block pedestrian crossing location.
Traffic circles (TC-5)	Raised circular islands positioned in the center of an intersection, designed to slow traffic by requiring traffic to maneuver around the circle. Typically controlled by "yield on entry" on all approaches. Smaller than mini-roundabout.	Use in series or in conjunction with other traffic calming measures. Should not be used on critical emergency response routes. Only appropriate for use on neighborhood streets.
Raised intersections (TC-6)	Raised plateau where roads intersect. Surface of plateau may be textured and colored. Plateau usually flush with top of adjacent curbing. Approaches are ramped like speed humps.	The corners of the intersection should be defined to keep motor vehicles off adjacent sidewalks at the plateau level. Crosswalks should be at level of plateau and properly delineated.
Curb extensions (TC-7)	Reductions of roadway widths at intersections by extending curbs toward the center of the roadway.	Appropriate wherever there is on-street parking and curbs. Maintain lane width for motor vehicles and bicycles along length of curb extension. Engineer drainage carefully.
Raised Medians (TC-8)	Islands in the center of a street to separate opposing traffic lanes and restrict or channelize turning movements. May include a pedestrian crossing and be used as a refuge island.	Most critical on high volume, high speed collectors and arterials. Maintain travel lane and shoulder/bike lanes on each side of median.
Roundabouts (TC-9A)	Intersection design featuring a raised circular island in the center with "yield on entry" and deflecting islands on all approaches. Traffic proceeds counterclockwise. Outer diameter is typically between 25-40 m (80-130 ft).	Flexible design parameters can adapt to many road types and locations. Bicyclists can travel through the roundabout or be accommodated on adjacent widened sidewalks.
Mini-roundabouts (TC-9B)	A small single-lane roundabout with a center that is completely traversable (unlike normal roundabout) for use in compact intersections.	Bicyclists can travel through the roundabout or be accommodated on adjacent widened sidewalks.
Cul de sacs and closures	Streets closed to through motor vehicle traffic through use of planters, bollards or barriers.	Typically concentrates traffic on other streets. Provide access for pedestrians and bicyclists at end of cul de sac to other streets.
Curb radius reduction	A smaller radius at an intersection corners, usually no more than 5 m (16 ft). May be as little as 3 m (10 ft).	Unsuitable where there are many trucks making the right turn; otherwise useful at most major-minor and minor-minor street intersections.
Gateway Treatments	Generally, a landscaped island in the street at the entrance to a neighborhood. Indicates a change from a major road to a lower speed residential or commercial district.	Often used in conjunction with medians, curb extensions and pavement treatments. Most effective in speed reduction if it initiates a consistent new streetscape.
Landscaping Treatments	Vegetation (e.g., street trees, bushes, flowers, grass, etc.), surface treatments (lawns, ground cover, mulch, sand, gravel, pavements), water features (pools, fountains, waterways), focal points (sculpture, flags, pennants, nighttime illumination), median and corner treatments, pathways, signs, textures and color.	Place between streets and sidewalks to maximize effect on slowing traffic. Place where increased levels of walking and bicycling are to be encouraged or expected. Use durable products and materials that are hardy and require low maintenance. Ensure that sight distance is not compromised.



**Physical Improvements, continued**

Measure	Description	Considerations
Lane width reductions	Reduction of travel lane widths to meet minimum dimensions as outlined in the VT State Standards	Excess space can be reconfigured to accommodate bicycle lanes, paved shoulders, sidewalks, or parking lanes.
On-street parking	Create "friction" by allowing cars to park on the street. May reduce width of travel lanes to minimum.	Coordinate minimum roadway clear width with emergency response personnel. Alternating on-street parking from one side of a road to the other creates a chicane effect.
Partial closures	Physical barrier that restricts turns or entry into a two-way street. Creates a one-way segment at the intersection while maintaining two-way travel for the rest of the block.	Provisions should be made to allow bicyclists to choose any route. Typically increases traffic on other streets.
Pavement treatments	Pavement surfaces that highlight sections of the roadway to increase drivers' awareness of certain conditions. May incorporate use of color, texture or a combination of these measures.	Often used to indicate areas where pedestrians may be expected. Avoid use of excessively-textured materials (that vary more than 6 mm or 0.25 in.) that may interfere with mobility of disabled pedestrians.

**Traffic Control**

Measure	Description	Considerations
All-way stop signs	Signs at every leg of an intersection that requires a vehicle to come to a complete stop.	Can provide marked crosswalks where sidewalks exist. May place stop lines in advance of pedestrian crossing areas.
Roadway striping	Pavement marking that highlights sections of the roadway to increase drivers' awareness of certain conditions. May be used to create bike lanes or to define paved shoulders.	May be used in conjunction with lane reductions to redistribute roadway among other users.
Signed turn restrictions	Signs that prohibit certain movements at intersections during specified periods.	Consider making turn restrictions applicable to motor vehicles only and not bicycles.
Truck restrictions	Signs that define where truck weight limits apply or where trucks are prohibited.	Truck restrictions should be compatible with adjacent land uses.

**Enforcement**

Measure	Description	Considerations
Speed reader	Radar displays mounted on mobile trailers that inform drivers of their speed.	Trailer should not block sidewalks, bike lanes or roadway shoulders.

**7.2.2 Traffic Calming Measures**

Table 7-1 summarizes the most common traffic calming measures suitable for Vermont. Cost ranges are not listed because they vary widely.

Consult the resources in Section 7.3 and the VTrans Standard Drawings for more detail. Roundabouts are discussed separately in Section 7.2.4. There are also signs and pavement markings that comply with the MUTCD that should be used with any traffic calming device.

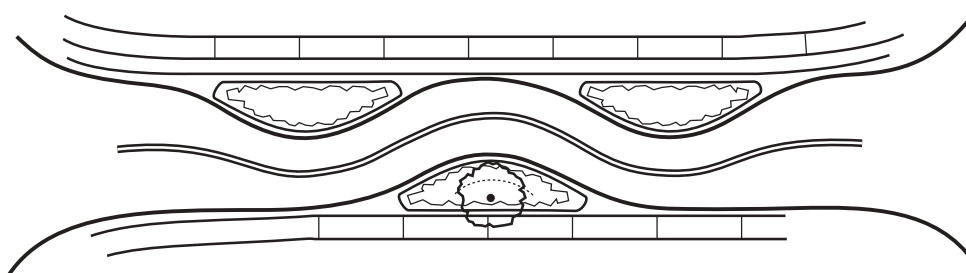

**Figure 7-2.**  
Chicane.

Alachua, FL



**Chicane.**

Montgomery County, MD



Curb extensions.

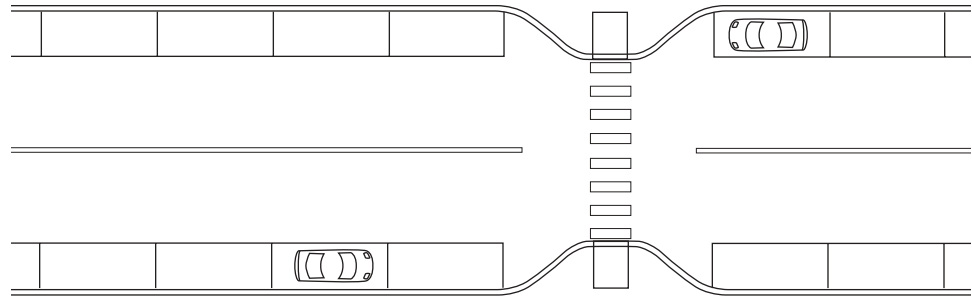
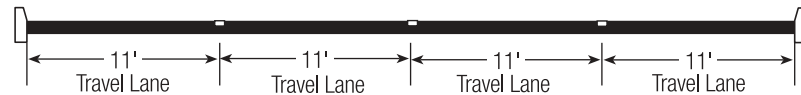
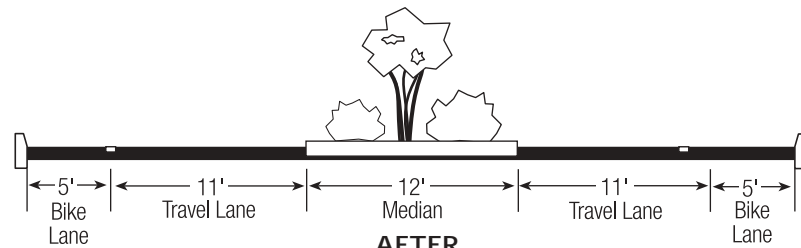

Figure 7-3.  
Curb Extensions.



BEFORE



AFTER

Figure 7-4.  
Lane Reductions.

Amherst, NY



Raised median.

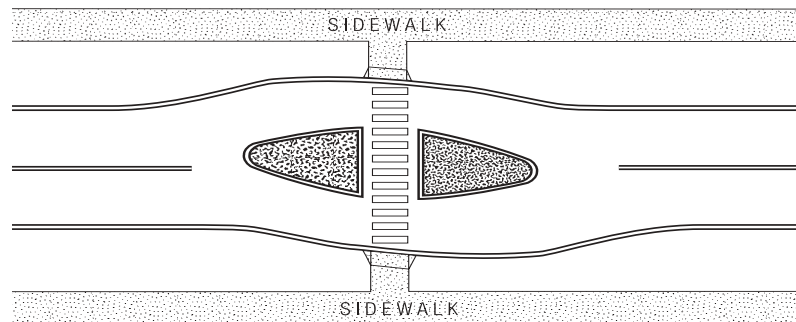

Figure 7-5.  
Raised Median.

Tallahassee, FL



Speed table.

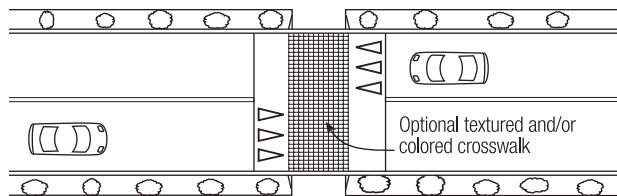

Figure 7-6.  
Speed Table with Optional Crosswalk.

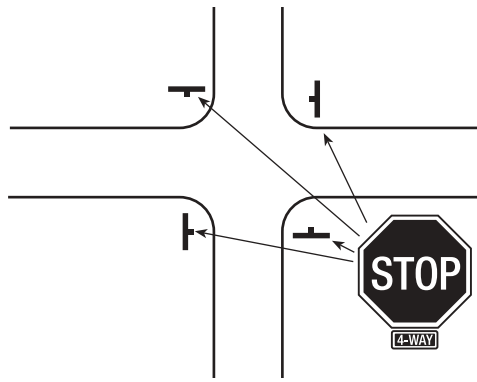

Figure 7-7  
All-Way Stop Signs

### 7.2.3 Minimizing Impacts on Pedestrians and Bicyclists

There is the potential, when applying measures to reduce speed and reduce volume of motor vehicles, to simultaneously create impediments to walking and bicycling. Be aware of this and seek ways to:

- Maintain the continuity of the pedestrian and bicycling networks,
- Ensure access to destinations,
- Eliminate barriers that impede or discourage walking and bicycling, and
- Reduce speed differentials between motor vehicles and non-motorized street users.

**Maintain the continuity of the pedestrian and bicycling network.** Physical changes made to affect the behavior of drivers should not interrupt the continuity of adjacent pedestrian and bicycle networks. For example:

- Where splitter islands or medians are planned in proximity to pedestrian crossings, equip the islands and medians with paved walking areas that connect to crosswalks. Install curb ramps on all sidewalks leading to crosswalks.

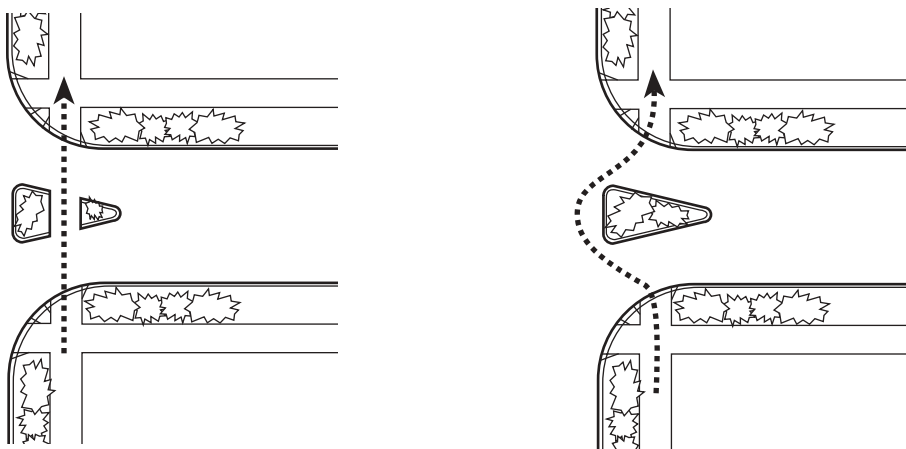

This

Not This

Figure 7-8.  
Maintain Walkway Continuity at Splitter Islands

- Where bicycle facilities such as bike lanes, wide curb lanes or paved shoulders exist, ensure that bicyclists will not be required to weave in and out of traffic, or to at least warn both motorists and bicyclists that such movements may be required.

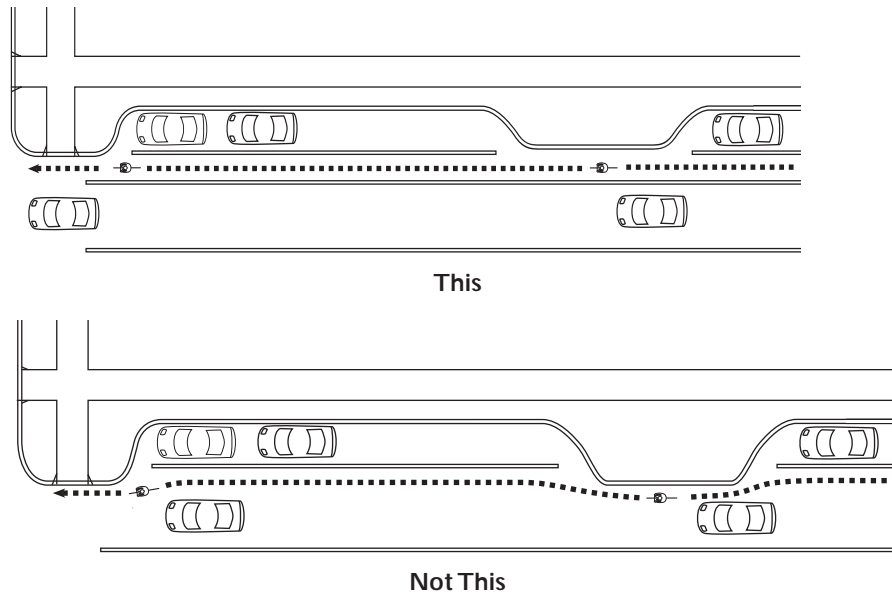

**Figure 7-9.**  
Maintain Bikeway Continuity at Curb Extensions

- Where on-road bicycle facilities exist, ensure that traffic calming devices do not force bicyclists to share sidewalks with pedestrians. Where it is expected that cyclists will use a sidewalk, it should be widened to shared use path dimensions (minimum 2.4 m [8 ft]).

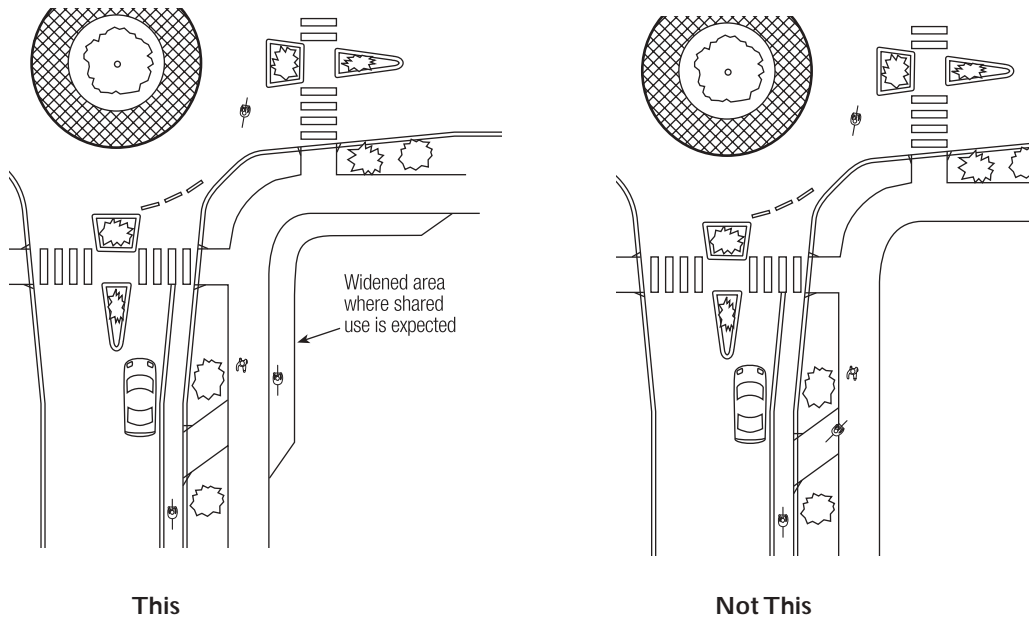

**Figure 7-10.**  
Provide Shared Use Path to Accommodate Pedestrians and Bicyclists

**Ensure access to destinations.** Some traffic calming intentionally restricts access to destinations to discourage through traffic. Where these measures are implemented, maintain passage for bicyclists and pedestrians.

- Where medians are installed in an area with a mid-block crossing, place a cut-through in the median to allow pedestrians to cross the street. Where the median is 2.4 m (8 ft) or wider, angle the crossing area by 30 degrees toward on-coming traffic to encourage pedestrians to watch for approaching traffic.

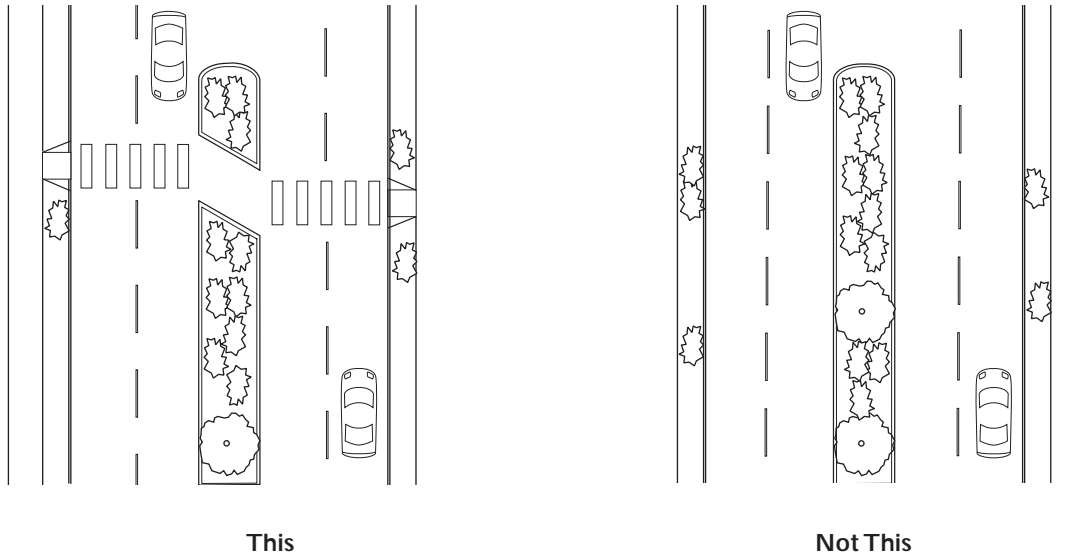

**Figure 7-11.**  
Ensure Access at Medians.

**Eliminate barriers that impede or discourage walking and bicycling.** Physical changes made to affect the behavior of drivers should not create barriers that impede or discourage walking and bicycling. For example:

- Where roadways are blocked to create cul de sacs, provide a passageway for through travel by pedestrians and bicyclists.

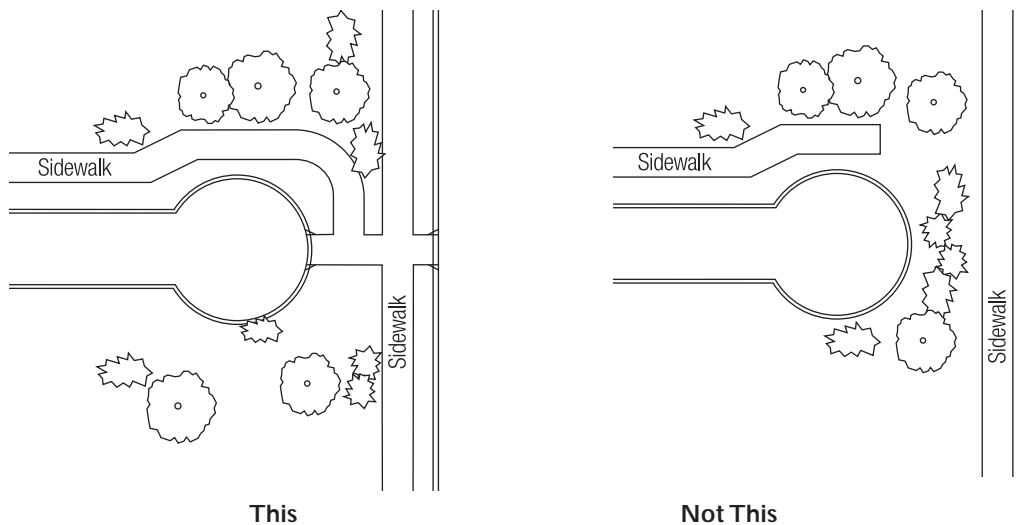

**Figure 7-12.**  
Provide a Passageway at Cul-de-sacs.

- Where traffic islands are installed to divert motor vehicle traffic, ensure that they do not create barriers that impede or discourage walking or bicycling. See below.

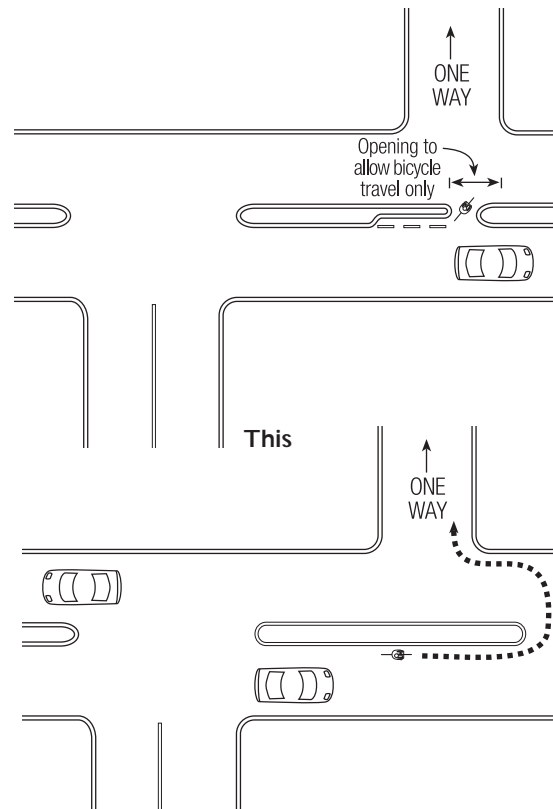

**Not This**  
**Figure 7-13.**

Provide a Passageway at Medians.

Reduce speed differentials between motor vehicles and non-motorized street users. An unintentional result of traffic calming may be that drivers accelerate between slow points. This not only subjects pedestrians and bicyclists to high speed differentials but adds to noise and air pollution. Ensure that speeds are relatively consistent throughout the traffic-calmed area. For example:

- The placement of widely spaced traffic calming devices may cause drivers to increase their speed between the devices to make up for lost time. Where this effect is likely, a combination of traffic calming measures or careful spacing of devices may be in order.

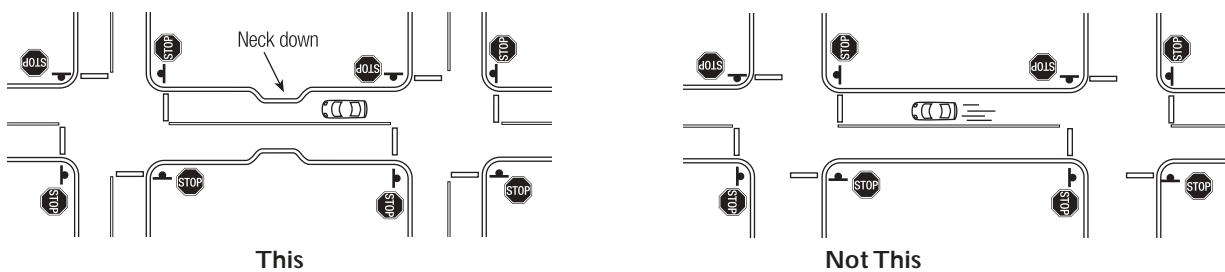

**Figure 7-14.**

Use a Combination of Measures to Produce the Desired Effect.

## 7.2.4 Roundabouts

### Description

Along with other traffic calming devices described in this chapter, roundabouts may present challenges to some pedestrians and bicyclists.

### Roundabout Characteristics

Roundabouts are a form of intersection control intended for use on high volume arterial and collector streets. Roundabouts often appear in lists of traffic calming measures because they typically slow traffic speed and reduce the number and severity of motor vehicle crashes. The principal function of a roundabout, however, is to increase the capacity of an intersection. Therefore, roundabouts are an alternative to signalization when traffic volumes indicate that a signal may be warranted. Design details for roundabouts can be found on VTrans Standard Drawing TC-9A (and TC-9B for mini-roundabouts.)

Roundabouts and mini-roundabouts have many similar design characteristics. Mini-roundabouts are distinguished by their smaller diameter central island, splitter islands that may consist only of a paint (i.e., not raised), and a fully mountable central island.

The design and operating characteristics of roundabouts generally have neutral or beneficial safety effects for pedestrians and bicyclists.

The common design characteristics of all modern roundabouts include:

- Continuously moving traffic that travels in counterclockwise direction around a center island (except in the U.K, Australia and other left-side driving countries).
- The center island, preferably raised and landscaped, is surrounded by a low “apron” so the rear wheels of large vehicles can track over the apron, if necessary. The entire island may be traversable in a mini-roundabout.
- Raised splitter islands channel approaching traffic through a narrowed entry throat at each leg of the intersection. Splitter islands also function as street-level pedestrian refuges that connect with marked crosswalks.
- Vehicles yield at the edge of the circulating roadway until a gap in the circulating traffic flow becomes available.
- Design speeds at the entry throat range from 25 to 35 km/h (15 to 20 mph). The geometry of the circulating roadway of a roundabout should limit speeds to 50 km/h (30 mph) or less.
- Single-lane entries are typical but a second “bypass lane” may be incorporated into larger roundabouts to accommodate high-volume movements.
- The outside diameter of a single lane roundabout (including the circulating travel lane) ranges from 25 to 40 m (80 to 130 ft), or as little as 13 m (45 ft) for a mini-roundabout.

### Benefits of Roundabouts for Bicyclists and Pedestrians

- Single lane roundabouts can result in increased pedestrian safety because crossing distances are shortened.
- Pedestrians only have to cross one direction of traffic at a time at each approach.
- Potentially conflicting vehicles come from a more defined path in a roundabout than a comparable signalized or stop controlled intersection.
- Properly designed roundabouts will result in a reduced speed differential between cyclists, pedestrians and motorists, which can lessen the severity of a crash.

Montpelier



**Roundabouts are a form of intersection control designed to increase the capacity of intersections on high volume arterial and collector streets. As such, roundabouts may present challenges to some pedestrians and bicyclists.**

- The overall number of conflict points among vehicles, bicyclists and pedestrians is reduced when compared to a traditional intersection treatment.

Some of these benefits diminish in multi-lane roundabouts. Although roundabouts are generally seen as benefiting pedestrians, careful attention must be paid to design details to address the concerns of both pedestrians and bicyclists.

### **Bicyclists' Concerns**

The principal concerns of bicyclists at roundabouts are:

- Having their operating space on the roadway narrowed or eliminated on the approach to the roundabout
- Conflicts with pedestrians if transitioning onto an adjacent sidewalk or shared use path.
- Having to merge with continuously flowing traffic on the roadway where fewer gaps in traffic are likely to occur
- Having to deal with merging traffic that is either entering or exiting the roundabout when a bicyclist chooses to remain on the road and travel as a motor vehicle.

As an alternate to riding in the roundabout, some roundabout designs provide a way for bicycles to leave the roadway and merge with pedestrians on an adjacent shared use path. This method may require that bicyclists come to a stop at every leg of the roundabout and wait for a gap in the free flowing traffic before they can cross a travel lane.

**Possible solutions.** The best way to address bicyclists' concerns and to accommodate bicyclists at roundabouts may be to:

- Slow the speed of motor vehicles to the average operating speed of a bicycle 13 to 19 km/h (8 to 12 mph),
- Maintain operating width of the bikeway and related lane striping (where bike lanes or paved shoulders exist in advance of the roundabout) up to the crosswalk, or to the yield line if there is no marked crosswalk.

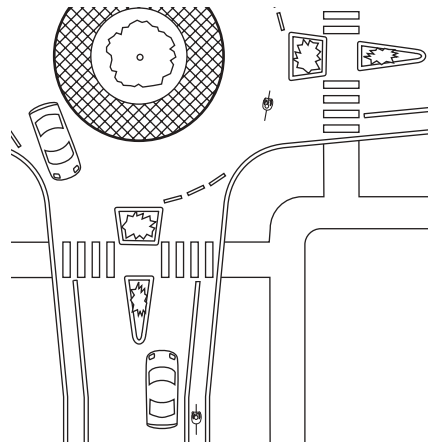

**Figure 7-15.**  
Maintain Operating Width of the Bikeway up to the Crosswalk.

- In shared roadway situations, provide adequate opportunities for merging with traffic well in advance of the roundabout.
- Where the opportunity exists, provide an alternate route of travel on a shared use path (not just a sidewalk) adjacent to a roundabout. Access from the road-



way to the path is provided by ramps that allow easy transitions for bicyclists between on-road and off-road facilities. Where pedestrians are accommodated at a roundabout, walkways should be widened to the width as required for a shared use path to also accommodate bicyclists. An access ramp to the sidewalk does not need to be textured as would a pedestrian ramp. Make sure the bicycle ramp is not misconstrued by pedestrians as an unmarked pedestrian crossing, and that the bicyclist can reenter the roadway from the pathway safely. Always maintain the on-road route of travel for bicyclists where an off-road option is also provided.

- Do not continue the bike lane into the circulating lane of the roundabout. Experience has shown that roundabouts with bike lanes adjacent to the circulating roadway may be hazardous for bicyclists. However, the overall width of the circulating lane should be designed to allow concurrent presence of bicycles and motor vehicles.

### Pedestrians' Concerns

The principal concerns of pedestrians at a roundabout are:

- Being able to cross the intersection where no signal protection is provided, where traffic may be constantly moving or when traffic may block a crosswalk.
- Visually impaired pedestrians, who rely upon their hearing to detect gaps in traffic, may have difficulty crossing roadway approaches.

Roundabout designs place crosswalks one car length back from the yield line. The MUTCD recommends that the minimum distance between a crosswalk marking and the yield line be 7.6 m (25 ft). This location may increase the likelihood that motor vehicles will come to a stop over a crosswalk creating a barrier for pedestrians. Moreover, a driver may fail to see a pedestrian in a crosswalk if they are scanning for gaps in circulating traffic as they approach the roundabout.

Smooth, continuous traffic flow may create fewer gaps and reduce pedestrian crossing opportunities, especially at high-volume intersecting streets. In some special situations, a pedestrian-activated signal may be placed at roundabout crosswalk locations to help visually impaired pedestrians or pedestrians with disabilities cross the roadway.

Multi-lane vehicle approaches and exits can present a multiple threat to pedestrians, where the car in the near lane may stop but the car in the second lane does not. This problem may also exist at standard intersections and is difficult to solve. The best advice is to avoid multi-lane configurations where possible and, if they must be used, consider painting a stop bar (with a sign STOP HERE FOR PEDESTRIANS) at least a car-length back from the crosswalk to improve sight distance from the second car.

Roundabouts can create unique problems for vision-impaired pedestrians. Vision-impaired pedestrians use their hearing at intersections and street crossings to detect when it is safe to cross an entry or exit lane (i.e. they listen for gaps in traffic or for lack of traffic movement). With the potential for constantly moving traffic at roundabouts, vision-impaired pedestrians may be unable to detect when it is safe to cross the street because traffic noise may never abate. Traffic in the circulating lane of the roundabout may mask other noises.

**Possible solutions.** Based upon the current state of the practice, the best ways to accommodate pedestrians at roundabouts are:

- Use curb ramps and marked crosswalks at each leg of the roundabout. Position crosswalks to bisect splitter islands, which also serve as pedestrian refuges. Lo-

Montpelier



Position pedestrian crosswalks to bisect splitter islands.

cate refuges at street level. Where a crosswalk traverses the splitter island the preferred design is a cut-through with curbs and detectable warnings as shown in Figure 7-17. Crown or slope refuges at a grade not exceeding 1:20.

- Textured and colored crosswalks may be used at crossings and islands.

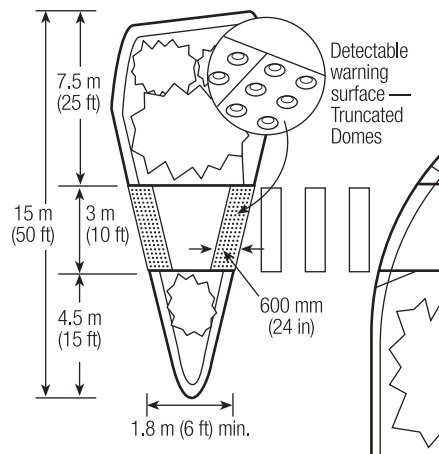

**Figure 7-16.**  
 Use Textured and Colored Crosswalks at Crossings and Islands.

- Minimize crossing distances by making crosswalks as straight as possible.
- If bicycles are expected to use the sidewalk, ensure that a width suitable for a shared use path is provided.
- To assist vision-impaired pedestrians, consider using “all red” pedestrian-actuated signals to stop traffic on demand. A pedestrian-activated signal equipped with locator tones can further assist people with visual impairments.

### 7.3 *Additional Resources*

Users of this manual are encouraged to consult the following resources for the broadest coverage of issues relating to the planning and design of measures intended to calm traffic, benefit walking and bicycling and foster more livable communities.

- *VTrans Traffic Calming Study and Approval Process for State Highways*. 2002.
- *Bicycle Facility Planning*, American Planning Association. 1995.
- *History of Sprawl in Chittenden County*, The Champlain Initiative. 1999.
- *Smart Growth: More Efficient Land Use Management*, Victoria Transport Policy Institute. 2001.
- *Streets and Sidewalks, People and Cars: The Citizen’s Guide to Traffic Calming*, Local Government Commission Center for Livable Communities. 2000.
- *Roundabouts: An Informational Guide* (FHWA-RD-00-067), FHWA, USDOT. See [www.tfhrc.gov/safety/00068.htm](http://www.tfhrc.gov/safety/00068.htm). June, 2000.
- *Traffic Calming Benefits, Costs and Equity Impacts*, Victoria Transport Policy Institute. 2001.
- *Traffic Calming Primer*, Pat Noyes and Associates. 1998.
- *Traffic Calming: State of the Practice*, FHWA, USDOT. 1999.
- *Traditional Neighborhood Development: Street Design Guidelines*, Institute of Transportation Engineers (ITE). 1999.
- VTrans Standard Drawings.

CHAPTER 8:

# Signs, Pavement Markings and Signals



## *Contents*

8.1 Introduction .....	8-3
8.1.1 Application .....	8-3
8.1.2 Applicable Guidelines and Standards .....	8-5
8.2 Pedestrian Facilities .....	8-5
8.2.1 Signs .....	8-5
8.2.2 Markings .....	8-6
8.2.3 Signals .....	8-6
8.2.4 Innovative Pedestrian Signal Treatments .....	8-9
8.2.5 Construction Zones and Temporary Access .....	8-10
8.3 On-Road Bicycle Facilities .....	8-12
8.3.1 Signs .....	8-12
8.3.2 Markings .....	8-15
8.3.3 Signals .....	8-17
8.3.4 Construction Zones and Temporary Access .....	8-20
8.4 Shared Use Paths .....	8-21
8.4.1 Signs .....	8-21
8.4.2 Markings .....	8-22
8.4.3 Railroad Crossings .....	8-22
8.4.4 Construction Zones and Temporary Access .....	8-22
8.5 School Areas .....	8-23
8.6 Additional Resources .....	8-23

## *Figures*

8-1 Regulatory Sign Examples .....	8-3
8-2 Warning Sign Examples .....	8-4
8-3 Guide Signs .....	8-4
8-4 Sidewalk Closure .....	8-11
8-5 Sidewalk Closure .....	8-12
8-6 Bike Lane Signs .....	8-13
8-7 W11-1 Sign with W16-1 Plaque .....	8-13
8-8 Transition From a Path to a Road With Little or No Shoulder .....	8-13
8-9 Sign Warning of Bicycle Crossing .....	8-14
8-10 Bicycle Route Sign Placement .....	8-14
8-11 Bicycle Route Guide and Bicycle Route Marker .....	8-15
8-12A Preferred Bicycle Lane Marking .....	8-16
8-12B Shared Use Lane Arrow .....	8-16
8-13 Object Marking .....	8-17
8-14 Quadropole Loop Detector .....	8-18

*Signs, Pavement Markings  
and Signals*

8-15 Diagonal Quadrupole Loop Detector ..... 8-18  
8-16 Standard Loop Detector ..... 8-18  
8-17 Pavement Marking to Identify a Bicycle Sensitive Location ..... 8-19  
8-18 Sign Placement on Shared Use Paths ..... 8-21

***Tables***

8-1 Comparison of Alternative Pedestrian Phasing ..... 8-8



## 8.1 Introduction

The wide variety of signs, signals, pavement markings, and other items like delineators (such as barrels or cones) are collectively known as traffic control devices. Traffic control devices are used to regulate, warn or guide pedestrians, bicyclists and motorists.

The most visible devices are at or near intersections where the majority of conflicts occur. These include common devices such as STOP and YIELD signs, traffic signals, delineators, and marked crosswalks. Other devices may be found at non-intersection locations such as mid-block crossings. Still other devices are found along the entire length of a street such as lane lines.

### 8.1.1 Application

The use of signs, markings and traffic signals should be uniform and consistent to command the respect of the public and provide safety to users. Installation should be warranted by use and need per the latest edition of the *Manual on Uniform Traffic Control Devices for Streets and Highways* (MUTCD).

#### Signs

The function of signs is to convey regulations, warnings and guidance information to road users. Both words and symbols are used to convey the messages. The MUTCD requires that all traffic control signs be retroreflective or illuminated.

#### Regulatory Signs

Regulatory signs give notice of traffic laws or regulations that bicyclists, pedestrians and motorists are required by law to follow. Examples of regulatory signs include signs for bicycle lanes, no parking, stop, yield, and others as shown in Figure 8-1. Most regulatory signs are rectangular in shape with black letters or symbols on a white background.

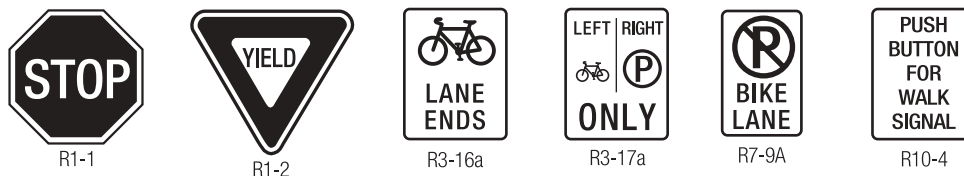
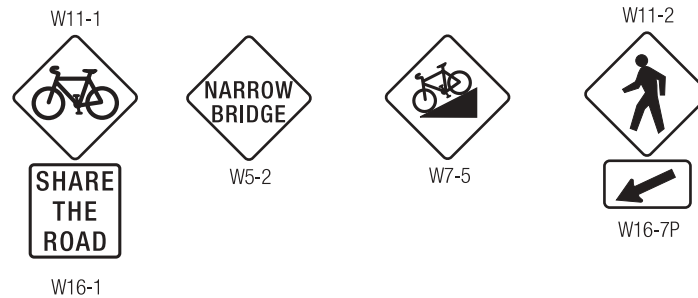

**Figure 8-1.**  
 Regulatory Sign Examples.

#### Warning Signs

Warning signs call attention to unexpected conditions on, or adjacent to, a roadway, bicycle or pedestrian facility that are potentially hazardous to users. Warning signs alert users to conditions that might call for a reduction of speed or some other specific action. The use of warning signs should be kept to a minimum so as not to dilute their effectiveness. Examples of warning signs include signs for crossings, narrow road or bridge sections, upcoming intersections and others as shown in Figure 8-2. Most warning signs are diamond shaped with black letters on a yellow background. Warning signs often include a supplemental plaque that is rectangular in shape and may contain messages such as “Next 2 Miles” or “Share the Road”.

The current version of the MUTCD allows signs associated with pedestrians, bicycles, schools and school buses to either be the standard black on yellow or black on fluorescent yellow-green. It is current VTrans policy to use the fluorescent yellow-green background for all school zone signs and for pedestrian or bicycle crossing signs in areas with inadequate stopping sight distance. The MUTCD cautions against mixing the standard yellow with the fluorescent yellow green signs in a given area.



**Figure 8-2.**  
Warning Sign Examples.

**Guide Signs**

Guide signs direct drivers, pedestrians and bicyclists to destinations, identify routes and streets, identify nearby natural features and historical sites. The MUTCD includes categories of service, tourist and recreational guide signs. Guide signs often consist of a white message and border on a green background and are generally rectangular in shape as shown in Figure 8-3

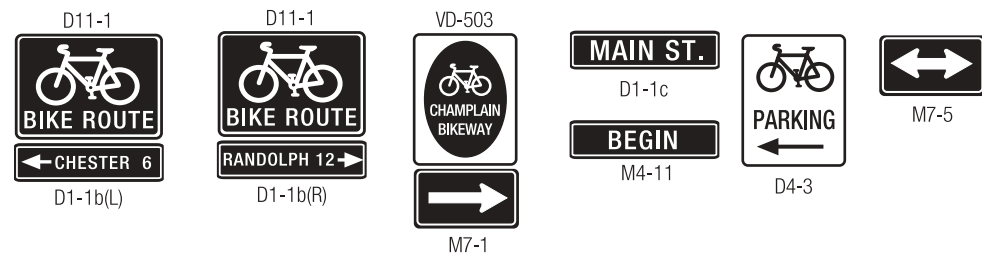

**Figure 8-3.**  
Guide Signs.

**Other Signs**

There are many other signs within the road right-of-way that are also covered in the MUTCD. These include gateway signs and historic marker signs. However, there are also many signs that are adjacent to and visible from the road, but are outside the road right of way. These signs are usually controlled by state and local ordinances regarding outdoor advertising, and may include on-premise business signs, local directional signs, information kiosks and historical markers.

**Pavement Markings**

Markings guide and inform road users about many roadway conditions. The most common markings are paint or durable markings on pavement, but markings also include curb markings, as well as devices placed in a vertical position such as object markers, delineators, barricades, channelizing devices (tubes, barrels and cones), and islands.

Some markings supplement other traffic control devices such as signs and signals (stop lines are an example). Other markings are used alone to convey regulations, guidance, or warnings in ways not obtainable by the use of other devices (lane lines are an example).

Visibility of markings can be limited by snow, debris, water, lighting, and wear. Markings that should be visible at night shall be retroreflective unless ambient illumination assures that the markings are adequately visible. Standard practice requires retroreflective markings for all situations.

### Signals

Signals directly affecting pedestrians and bicyclists include traffic control signals, pedestrian signals, and flashing beacons. Key issues with signals for bicyclists and pedestrians are signal timing, sensitivity of loop detectors for actuated signals, activation and timing of pedestrian phases, and conflicts with vehicle movements.

### Temporary Control

Temporary traffic control devices are installed most often in conjunction with a construction project or maintenance operation. Care should be taken to provide bicyclists and pedestrians with safe access through a temporary traffic control zone. Conditions in construction and maintenance areas are likely to change frequently which can surprise users and create an even higher degree of vulnerability for pedestrians and bicyclists. Portable or permanent sign supports should not be placed on sidewalks, bicycle lanes, shared use paths, and other areas designated for pedestrian or bicycle traffic. Refer to Section 8.2.5 for greater detail regarding this topic.

## 8.1.2 Applicable Guidelines and Standards

### Vermont Statutes Annotated (VSA)

VSA Title 23, Chapter 13, § 1025, requires that the state, towns, utilities, and others shall use the MUTCD as the standard when applying traffic control devices to state and town highways.

### Manual on Uniform Traffic Control Devices (MUTCD)

The MUTCD covers most situations where traffic control devices affect pedestrians and bicyclists. While guidance on traffic control devices that may affect bicyclists and pedestrians is found throughout the MUTCD, Part 9 specifically addresses traffic controls for bicycle facilities. The MUTCD is available on line at <http://mutcd.fhwa.dot.gov/>. It can also be purchased through the Institute for Transportation Engineers at [www.ite.org](http://www.ite.org), or the American Association of State Highway and Transportation Officials at [www.aashto.org](http://www.aashto.org).

## 8.2 Pedestrian Facilities

### 8.2.1 Signs

Few MUTCD signs are specifically directed toward pedestrians. Warning signs associated with pedestrian crossings are intended for motorists, but are intended to increase pedestrian safety. The most common standard regulatory signs that are oriented to pedestrians are associated with pedestrian signals (“Cross on Green Light Only” or “Push Button for Walk Signal” for example).

Because most MUTCD signing is oriented towards motorists, the positioning of these signs may not always address the needs of pedestrians. In particular, large guide signs oriented toward the roadway and containing information on how to reach destinations by driving may not be visible or applicable to pedestrians.

Conventional, smaller street name signs on street corners are useful to motorists and pedestrians who may be unfamiliar with an area. Adequate illumination of pedestrian-oriented signs is an important design consideration.

## *Signs, Pavement Markings and Signals*

An opportunity exists to enhance a pedestrian-oriented village or urban area through the use of pedestrian wayfinding signs. These signs may not be placed in state highway right-of-way, but rather on roads under local jurisdiction as needed to guide pedestrians to destinations. Care should be taken that the signs and posts are located to meet pedestrian and vehicle clearance requirements (see Chapter 3, Pedestrians). Additional guidance on this type of sign can be found in Chapter 9, Landscaping and Amenities.

### **8.2.2 Markings**

The most common pavement marking used by pedestrians is a marked crosswalk. Crosswalk markings are covered in detail in Chapter 3, Pedestrian Facilities, within Section 3.5.5 (Crosswalks). Detectable warnings for pedestrians are discussed in Section 3.5.4 (Curb Ramps).

Vertical markers (object markers, delineators, barricades, channelizing devices, and islands) should conform to the setbacks, clearances and shy distances in Section 3.4.2 (Sidewalks), and the corner obstruction-free area described in Section 3.4.5 (Corners).

### **8.2.3 Signals**

Given that the application and operation of traffic signals is codified in Part 4 of the MUTCD, there is limited flexibility in the use of signals though there are some actions that can be taken to help improve conditions for walking. These include:

- Signal timing changes to better accommodate slow pedestrians.
- Pedestrian-activated signals.
- In-roadway lights.
- Accessible pedestrian signals and pushbuttons.
- Auditory signals.
- Countdown signals.
- Leading pedestrian intervals.

#### **Signal Timing**

The timing of pedestrian signals is a critical element in ensuring that pedestrians can safely cross streets at signalized intersections. Designers should consult the MUTCD for the various design parameters associated with traffic signals. When pedestrian signal heads are used, there is a “walking” interval and a two-part “clearance” interval.

- The walking interval is indicated by a steady WALKING PERSON (symbolizing WALK) signal which means that a pedestrian facing the signal indication may start to cross the roadway in the direction of the signal indication, possibly in conflict with turning vehicles. The MUTCD notes that the walking interval should normally be at least 7 seconds so that pedestrians will have adequate opportunity to leave the curb or shoulder before the pedestrian clearance time begins. (A walking interval as short as 4 seconds is permitted under special circumstances of low pedestrian volume or to favor opposing signal phases.)
- The beginning clearance interval is indicated by a flashing UPRAISED HAND signal (symbolizing DONT WALK) and is calculated based on the distance being crossed and an assumed walking speed. The intent of this interval is to indicate to pedestrians that they should keep walking if they are already in the crosswalk but not leave the curb or shoulder if they have not started crossing. Don't walk is understandably confusing to many people.

The MUTCD allows the pedestrian clearance interval to be based on a normal



walking speed of 1.2 m/s (4 fps) and a distance from the curb (or edge of roadway) to at least the center of the farthest traveled lane. However, it is VTrans practice to use the full curb to curb or edge of roadway to edge of roadway distance. This practice is more in favor of pedestrians and can partially offset slower walking speeds.

While the standard practice is to use 1.2m/s (4 fps), VTrans practice is to use 0.9 m/s (3 fps) when designing a pedestrian signal that is expected to be used primarily by children or the elderly. This practice is supported by research that has been conducted regarding actual walking speeds. Normal walking rates vary from 0.8 to 1.8 m/s (2.5 to 6.0 fps) with an average of 1.2 m/s (4.0 fps). A report issued by the Institute of Transportation Engineers (ITE) states: "...the fifteenth percentile walking speed should be used for setting the design walk speed where there is a high proportion of elderly pedestrians. In the absence of a specific study this would be between 0.9 and 1.2 m/s (3 and 4 fps)..."

The Americans with Disabilities Act Accessibility Guidelines also shares the concern that a walking rate of 1.2 m/s (4.0 fps) of an able-bodied adult cannot be maintained by pedestrians affected by a mobility impairment, stamina or age. Although pedestrians who use wheelchairs typically travel faster than 1.2 m/s (4.0 fps), those who use other mobility aids (walker, cane, etc.) or who have gait or stamina impairments may travel at 0.5 m/s (1.5 fps) or less. Further, pedestrians who are blind or who have vision impairments typically delay leaving the curb until they can satisfy themselves that vehicles have stopped, thus delaying their start from the curb.

- The ending clearance interval is indicated by a steady UPRaised HAND (symbolizing DONT WALK) signal during which there is the yellow change interval and any red clearance interval (before a conflicting green is displayed). This symbol means that a pedestrian shall not enter the roadway.

Regarding pedestrian clearance requirements, VSA Title 23, Chapter 13, § 1025(c) requires:

"Traffic and control signals at intersections with exclusive pedestrian walk cycles shall be of sufficient duration to allow a pedestrian to leave the curb and travel across the roadway before opposing vehicles receive a green light. Determination of the length of the signal shall take into account the circumstances of persons with ambulatory handicaps."

Options available to the traffic engineer to address slower walking speeds include increasing the crossing time, decreasing the distance (using smaller curb radii or curb extensions), subdividing the distance (using medians or refuge islands, with separate pedestrian controls on the median), or providing a pedestrian-actuated control that permits extended-time crossing on demand.

**Concurrent and Exclusive Pedestrian Phases**

There are two main ways that a pedestrian crossing phase is included at a signalized intersection. A concurrent pedestrian phase is one in which the walking interval appears at the same time as parallel motor vehicle traffic receives a green indication. An exclusive pedestrian phase occurs when all motor vehicle traffic is stopped and pedestrians may cross any leg of the intersection, including diagonally across the intersection. There are operational and safety considerations with both methods as illustrated in Table 8-1.



All new pedestrian signal indications shall be displayed within a rectangular background and consist of symbolized messages.



Existing pedestrian signal indications with lettered messages may be retained for the remainder of their useful service life.

Table 8-1  
Comparison of Alternative Pedestrian Phasing

Concurrent phase	Exclusive phase
Generally results in less delay to motor vehicles and pedestrians	People with disabilities (especially visual impairments) do not need to be concerned with turning vehicles
Turning vehicles can conflict with crossing pedestrians	Results in longer delays for motor vehicles and pedestrians
May incorporate leading pedestrian interval to lessen conflicts with turning vehicles	Sometimes misunderstood by pedestrians
More widely used and recognized	Pedestrians often cross against the light concurrently with parallel traffic if no conflicts are apparent
Pedestrians must exercise more caution and judgment	Pedestrians feel more secure with no vehicle conflicts
	May require No Right Turn on Red regulation

### Midblock Pedestrian-Activated Signals

A traffic signal activated by a pushbutton at a midblock crosswalk may be appropriate where:

- Traffic volume on a major street and pedestrian volumes crossing the street are so heavy that pedestrians experience excessive delay in crossing (MUTCD Warrant 4, Pedestrian Volume),
- Large numbers of school children cross a major street with inadequate gaps in the traffic flow to accommodate those pedestrian volumes (MUTCD Warrant 5, School Crossing), or
- There have been many crashes involving pedestrians, high volumes of pedestrian traffic exist and other measures have not reduced the crash frequency (MUTCD Warrant 7, Crash Experience).

When gathering data for an engineering study of the crossing, note if there are any potential users not reflected in the data because the lack of a signal discourages them from crossing. For example, there may be nearby facilities and activity centers that serve the young, elderly, or people with disabilities who are not reflected in the existing data.

### Accessibility Considerations for Pedestrian Signals

Where pedestrian activated signals are used, the signal hardware should include additional features to aid blind or visually impaired pedestrians. Auditory or vibrotactile features are two typical treatments that provide information to these pedestrians. Accessible pedestrian signals (APS) are covered in Section 4E.06 of the MUTCD.

There are a wide range of options besides the familiar audible indicator that chirps or tweets to indicate the walk phase. Units are available that click or buzz at low frequencies and can indicate start times through vibration for people who are both deaf and blind. These units produce sound with less amplification than earlier units and may, therefore, be more acceptable in densely developed areas. Also available are pedestrian pushbuttons that produce a low-intensity, low-frequency click, allowing pedestrians with vision impairments to locate the control easily. Making the existence and location of the actuating device known to blind users has been a long-standing problem in pedestrian signal design.

When designing accessible pedestrian signals, it is advisable to work closely with the blind pedestrians who will be using the intersection and with an orientation and mobility specialist. Any APS chosen should be carefully installed and adjusted so as not to interfere with the ability of the blind pedestrian to hear the sound of traffic.

### Pedestrian Pushbuttons

Where a pushbutton or other operable device is provided for the use of pedestrians, the mechanism should not require more than 22 N (5 lbs) of force to activate. Because outdoor devices will often be used by pedestrians who are wearing gloves or whose movements may be restricted by bulky clothing, it is advisable to select the largest available pushbutton or bar dimension — a 50 mm (2 in) minimum is recommended — and to ensure that it is raised above the surrounding surface for ease of operation.

The location of pedestrian pushbuttons and design of the adjacent sidewalk area should consider the following recommendations:

- Pedestrian signal controls should be located within reasonable proximity of the curb ramp and crosswalk. Mount the bar or button within allowable reach ranges for pedestrians who use wheelchairs 106 cm (42 in) above finished grade.
- Provide a level surface 76 x 122 cm (30 x 48 in) of the same material as the adjacent sidewalk or path, centered on each control for a forward or side approach.
- For a forward approach locate the button in the same vertical plane as the leading edge of the clear ground space.
- For a side approach the clear ground space should be within 25 cm (10 in) horizontally of the button.
- Allow the button to be operated from a level landing rather than the sloped surface of a ramp.
- The push button location and associated tactile signing should clearly indicate which crossing direction is controlled.
- Buttons for different crossings should not be mounted on the same face of a pole.
- To the extent possible, pushbutton locations should be standardized to provide a more predictable walking environment for people with low vision or the blind.

### Auditory Pedestrian Signal Policy

VAOT's policy (August 26, 1981) for exclusive and auditory pedestrian signals is:

- Provide auditory capability for all pedestrian signal systems being designed.
- The audible signals will not be wired into the active circuits unless:
  - Need can be established when considering pedestrian counts, traffic, and handicap needs.
  - Engineering analysis indicates the installation will add to the safety of the pedestrian.
- Determination of need will be in consultation with other State agencies and advocacy groups.

### 8.2.4 Innovative Pedestrian Signal Treatments

There are a number of innovative pedestrian signal treatments that are being experimented with in VT and around the U.S. The overall intent of these treat-



Use the same material in front of a pedestrian signal control as is used for the adjacent sidewalk or path.



Auditory pedestrian signals may be provided when the need is established and an engineering analysis indicates the installation will add to the safety of pedestrians.

## **Signs, Pavement Markings and Signals**

ments is to make pedestrian crossings more safe, recognizing that there are conflicts inherent in any pedestrian road crossing. The following treatments are not an all-inclusive list, but are some of the treatments already being used in VT or likely to have applicability here. For a more complete discussion of the many treatments being used nationwide, refer to the ITE publication, *Alternative Treatments for At-Grade Pedestrian Crossings*.

### **In-Roadway Lights**

Lights embedded in the pavement that flash when a pedestrian is crossing help alert motorists to an unexpected crosswalk and to the presence of a pedestrian. These may be used only at marked crosswalks that are not controlled by YIELD signs, STOP signs, or traffic control signals. They provide improved yielding to pedestrians at night, when pedestrians are hardest to see.

In-roadway lights usually consist of flashing yellow LEDs placed at the center of each travel lane, at the centerline of the roadway, at each edge of the roadway or parking lanes, or at other suitable locations away from the normal tire track paths. They can be set for a predetermined period or can turn off when a passive detector determines that there are no pedestrians in the crosswalk. They are installed with standard crosswalk warning signs. Refer to MUTCD Chapter 4L, In-Roadway Lights.

### **Automated Pedestrian Detection**

Automated detection uses primarily either infrared or microwave technology to detect the presence of pedestrians in crosswalks. One objective of this treatment is to provide extended crossing time in the pedestrian phase to allow slower moving pedestrians to finish crossing the street. Another objective is to eliminate false calls if pedestrians have left the crosswalk, which enhances the overall operation of a signalized intersection.

### **Countdown Signal**

One potential problem with existing pedestrian signals is that pedestrians don't know how much time is left in the clearance interval. The result is that pedestrians leaving late in the clearance interval sometimes don't make it across before the light changes.

One solution being evaluated is to add a countdown timer to the pedestrian signal head. The timer provides a visual aid that counts down the time remaining for pedestrians to cross the intersection safely. This treatment has been installed at an intersection in Berlin, VT and its effectiveness is still being evaluated.

### **Leading Pedestrian Interval (Delayed Right Turn)**

A common problem at signalized intersections is the conflict between right-turning traffic and pedestrians. A simple solution is to give the pedestrian a head start by having the walk signal begin about three seconds before the green signal. This allows pedestrians to enter the crosswalk before turning traffic is released. This reduces conflicts between pedestrians and turning vehicles as well as the incidence of pedestrians yielding the right-of-way to turning vehicles.

## **8.2.5 Construction Zones and Temporary Access**

The MUTCD requires that advance notification of sidewalk closures be provided. The MUTCD also requires that devices used to delineate a temporary pedestrian walkway shall be crashworthy and, when struck by vehicles, present a minimum threat to pedestrians, workers, and occupants of impacting vehicles. Normal

vertical curbing shall not be used as a substitute for temporary traffic barriers when temporary traffic barriers are clearly needed.

When planning for pedestrians in temporary traffic control zones use these fundamental principles:

- Do not lead pedestrians into conflicts with work site vehicles, equipment and operations.
- Do not lead pedestrians into conflicts with vehicles moving through or around the work site.
- Instead, provide pedestrians with a safe, convenient path that replicates as nearly as practical the most desirable characteristics of the existing sidewalk(s) or footpath(s).
- Consideration should be given to separating pedestrian movements from both work site activity and motor vehicle traffic.

The design of temporary traffic control to direct and protect pedestrians should include the following considerations:

- 1) Use advance signing to encourage pedestrians to cross to the opposite side of the roadway if an adequate pedestrian facility is present. Where motor vehicle volumes are high, these signs should be placed at intersections so that pedestrians are not confronted with midblock work sites that will entice them to attempt skirting the work site or making a midblock crossing.
- 2) In locations where a continuous sidewalk or street crossing route cannot be provided for pedestrians — for example, when construction barricades intervene — an alternate route should be available. This may require temporary walkways and curb ramps to maintain access to destinations along a sidewalk obstructed for more than a short time. Temporary walkway surfaces should also meet ADAAG requirements.
- 3) Sidewalk barriers should be detectable by blind pedestrians or those who have low vision. Plastic tape, movable cones, and print signs will not generally provide adequate notice or protection as they do not provide a continuous surface detectable by a cane.
- 4) When pedestrian movement through a work site cannot be avoided, provide a separate walkway free of abrupt changes in grade or terrain.
- 5) Where fencing is used, it should not restrict the sight distance of road users.
- 6) Materials that would be hazardous if impacted by vehicles — such as wooden railings, fencing, or similar items placed immediately adjacent to motor vehicle traffic — should not be used as substitutes for crashworthy temporary traffic barriers. Adjustments to signal timing and provision for temporary lighting may also be needed in construction zones.
- 8) When a temporary route for pedestrians is established, it shall meet the ADAAG requirements.
- 9) Make provisions where it is necessary to protect pedestrians from falling debris.

Designers should also consult Part 6 of the latest edition of the MUTCD for more detailed guidance on providing pedestrian access and protection in the vicinity of work zones.

**Construction Zone Policies**

Ideally, construction zone policies should be developed to eliminate unexpected

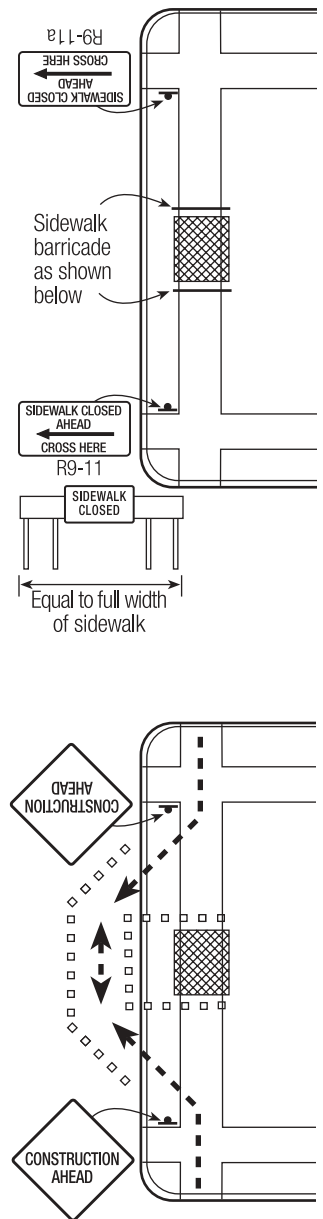

**Figure 8-4.**  
 Sidewalk Closure  
 Source: *Traffic Control  
 Manual for  
 In-Street Work*, Seattle  
 Engineering  
 Department.

## Signs, Pavement Markings and Signals

obstacles for pedestrians and make transitions as safe and smooth as possible. The following concerns should be addressed:

- Advance warning and guidance signs.
- Adequate illumination and reflectorization.
- Channelizing and barricading to separate pedestrians from traffic.
- Provisions for people with disabilities.
- Preventing pedestrians with sight impairments from entering work zones.
- Circumstances requiring temporary walkways.

It should be noted that the designer has a responsibility on federally-aided projects to develop a traffic control plan. However, contractors should be allowed flexibility as long as requirements are met. It's often difficult to plan ahead, as many traffic control decisions are made daily in the field. All parties involved should be made aware of the needs of pedestrians and be made responsible for ensuring safe and continuous passage.

Developing a workable policy for pedestrian access through construction zones requires the cooperation of traffic engineers, construction inspectors, crew chiefs, contractors, and pedestrian advocates. The policy should apply whenever construction or maintenance work affects pedestrian access, whether the work is done by private firms or city, or state crews.

**Link to construction permits.** Make sure that permits required for construction which encroaches upon sidewalks or crosswalks is contingent upon meeting pedestrian access policies. Give contractors copies of any requirements when they apply for a permit. Incorporate the requirements into contracts, agreements or specifications.

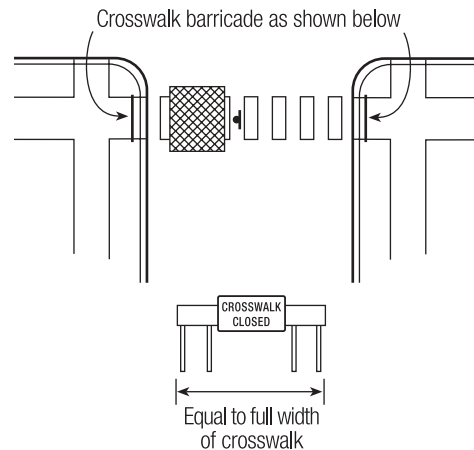

**Figure 8-5.**  
Crosswalk Closure

Source: *Traffic Control Manual for in-Street Work*, Seattle Engineering Department.

## 8.3 On-Road Bicycle Facilities

When preparing detailed plans for installation of signs, pavement markings and signals for on-road bicycle facilities, consult Part 9, Traffic Controls for Bicycle Facilities, of the latest MUTCD for specific guidance.

### 8.3.1 Signs

Bicyclists using on-road facilities are required to follow the rules of the road for all vehicles, therefore regulatory and warning signs that will be in place for motor-

ists will also be applicable to and useful for bicyclists. However, there are unique signs associated with the different bicycle facility types. Most of the unique bicycle signs and pavement markings are covered in Part 9 of the MUTCD, Traffic Controls for Bicycle Facilities.

**Regulatory Signs**

Use standard MUTCD regulatory signs for bicycle lanes. These signs emphasize the preferential or exclusive use by bicycles of bike lanes (or shared use paths) by restricting motor vehicles from such facilities.

MUTCD signs R3-16 and R3-17 designate the presence of a bike lane. Where appropriate the word message “ENDS” may be substituted for “AHEAD” on the R3-16 sign.

STOP signs may be used to assign the right-of-way to bicyclists using high volume, established bikeways at the intersection with low-volume roads. Such applications may be particularly effective where sight obstructions exist. The decision to install such a STOP sign should take into account the relative traffic volumes, possible sight distance improvements, and normal operating speeds on the road.

**Warning Signs**

A common bicycle warning sign is the standard yellow diamond Bicycle Warning (W11-1) sign which shows the profile of a bicycle. The W11-1 sign alerts the road user to unexpected entries into the roadway by bicyclists, and other crossing activities that might cause conflicts. The typical application is in advance of a location where a shared use path crosses the roadway. Refer to the MUTCD for guidance on placement.

The W11-1 sign may be used with a supplemental plaque with the legend SHARE THE ROAD (W16-1). The combination is intended to warn drivers that bicycles may be traveling on the roadway in a constrained area.

The sign indicates that both bicyclists and motorists are expected to share the road.

The SHARE THE ROAD sign should not be used indiscriminately. Some examples of situations where use of this sign may be appropriate include:

- Where there are gaps in paved shoulders, such as on an approach to a bridge that has no shoulders.
- After a bike lane ends and bicyclists and motorists enter a shared lane situation.
- On stretches of road that are used to connect two sections of a shared use path.



R3-16



R3-17

**Figure 8-6.**  
Bike Lane Signs.



W11-1



W16-1

**Figure 8-7.**  
W11-1 Sign with W16-1  
Plaque

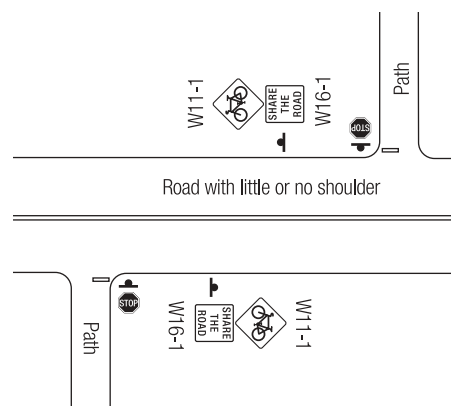

**Figure 8-8.**  
Transition from a Path to a Road with Little or No Shoulder

*Signs, Pavement Markings and Signals*

Other warning signs, such as BIKEWAY NARROWS (W5-4) and Hill (W7-5), may be installed on bicycle facilities to warn riders of unexpected or hazardous conditions not readily apparent. Such signs should normally be installed no less than 15 m (50 ft) in advance of the hazard.

The W11-1 sign can also be used in combination with other word messages plaques to warn bicyclists of impending hazards to cycling such as grooved shoulders, covered bridges or metal grate bridges.

Where floor boards inside a covered bridge can precipitate a bicycle crash, consider using a “slippery when wet” supplemental plaque (W8-10). Where skewed or angled railroad tracks are encountered use VW-376 as shown in Figure 8-9.



**Figure 8-9.**  
Sign Warning of Bicycle Crossing

**Bicycle Route Signs**

There are three different classifications of bicycle route signs outlined in the MUTCD. Bicycle Route Guide signs, Bicycle Route Markers and Interstate Bicycle Route Markers. The use of any of these signs should provide clear information to bicyclists and should not be indiscriminately used just to indicate a road where bicyclists may be riding. The use of bike route signs alone does not address physical deficiencies of a roadway.

Any Bicycle Route sign should be placed at decision points along a bikeway to:

- Inform bicyclists of bicycle route direction changes.
- Confirm that route direction has been accurately comprehended.
- Provide distance to popular destinations.

**Bicycle Route Guide Signs**

The MUTCD describes bicycle route signs as information signs designed to guide bicyclists to their destinations. These signs would most likely be used to guide bicyclists to a specific local destination or to indicate continuity between various bike facilities, such as from a shared use path to bike lanes along a roadway.

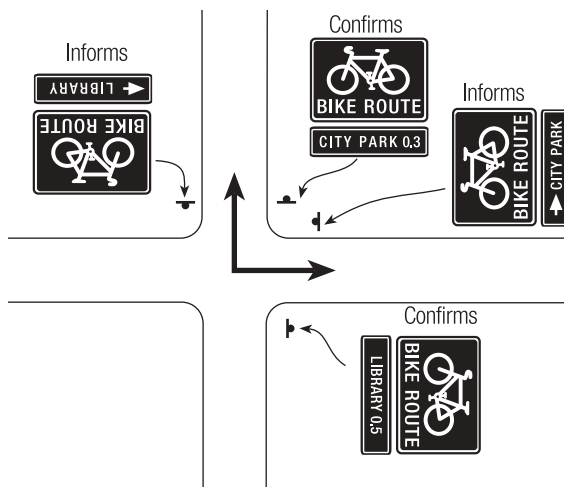

**Figure 8-10.**  
Bicycle Route Guide Sign Placement.

Where used, Bicycle Route Guide signs should be placed after intersections with major side streets to ensure that bicyclists entering from the side street know they are on a bicycle route.



To provide navigational information, supplemental plaques should be used with bicycle route signs to convey:

- Destination of the route,
- Distance to the desired destination, or
- Direction of travel.

The use of the Bike Route (D11-1) sign by itself is strongly discouraged as it does not provide adequate information to bicyclists.

One disadvantage of “Bike Route” signs is that some drivers of motor vehicles, may infer that bicyclists have no rights traveling on roads not formally marked as a “bicycle route”. This however is not the case nor the intent of use of the bicycle route sign.

**Regional Bicycle Route Marker Signs**

Bicycle route markers (VD-503) may be used to establish unique identification through designation of state or regional routes such as:

- Long distance multi-jurisdictional routes that connect one or more communities.
- Long distance multi-jurisdictional routes between counties, states or countries.
- Connections to a regional bicycle network.

When several jurisdictions are responsible for bikeway implementation within an area, it may be difficult to coordinate a logical and meaningful bikeway numbering or naming system. In such cases, a unique regional sign system can be designed to differentiate long distance routes from local routes. (The MUTCD allows for variance in sign design where messages other than those provided in the MUTCD are needed.) The regional bike route marker sign system being used in Vermont is similar to the Champlain Bikeways system of signs that identifies bicycle routes in the Lake Champlain Basin (refer to Figure 8-11). Any modifications to the supplemental plaques used with the route markers should conform with the MUTCD.

**Interstate and International Route Signs**

Although not currently in use in Vermont, where a bicycle route extends for long distances through two or more states, a coordinated submittal by the affected states for assignment of route number designations may be submitted to AASHTO. If such a route is being considered, the latest version of AASHTO’s Interstate Bicycle Route Numbering Policy should be consulted.

To our north, the Province of Quebec has embarked upon an ambitious bicycle route designation process known as La Route Verte (the Green Road). Provincial authorities have approved a system of signs and design guidance for the project. Where designated bike routes in Vermont link with La Route Verte in Canada, consider installing signs in Vermont directing bicyclists to the Canadian network.

**Wide Curb Lanes, Shared use Lanes and Paved Shoulders**

Other than warning signs as previously discussed, there are no special signs associated specifically with on road bicycle facilities other than bike lanes. However, bicycle route signs may be installed in combination with any type of bicycle facility when it is part of a designated route.

**8.3.2 Markings**

Markings are used to reinforce and supplement signs and to provide direct communication to the user. Pavement markings are particularly effective for bicyclists as their placement on the pavement is directly in front of the bicyclist’s line of sight.



D1-1b(L)

Bicycle Route Guide



M7-1

Bicycle Route Marker

**Figure 8-11.**

Bicyclists main concern with pavement markings is that they be slip resistant. For this reason, paint is preferred. Many jurisdictions use durable markings (most often thermoplastic) because they can wear longer. Specifications for durable markings should ensure that they are slip resistant and will not become a hazard for bicyclists.

VTrans has experimented (in cooperation with a durable pavement marking manufacturer) with the application of skid resistant thermoplastic marking materials to reduce the slipperiness and increase the surface friction. By adjusting the application equipment, it is possible to reduce the thickness of the applied material from 115 mils to 90 mils without significantly reducing the life of the applied stripe. Adding crushed glass and sand to the mixture further increases surface friction of the stripe.

**Stripes and Lines**

Stripes (or lines) are principally used in conjunction with bike lanes to delineate a separate travel lane on the roadway for the preferential or exclusive use of bicycles. Such stripes encourage motorists to keep to the left and bicyclists to keep to the right. This contributes towards ensuring a more predictable path of travel for each type of user. Markings can also assist the bicyclist by indicating the correct position for traffic signal actuation, and provide advance information for turning and crossing maneuvers.

Bike lane stripes are a minimum of 150 mm (6 in) wide and are placed longitudinally between the bike lane and the adjacent travel lane. The standard color for bike lane stripes is white and the markings shall be retroreflectorized.

The only situation where a bike lane stripe is not as described above is when double yellow lines separate a contra flow bike lane from a travel lane as discussed in section 4.3.7.

Additional guidance on striping bike lanes can be found in Chapter 4, On-Road Facilities.

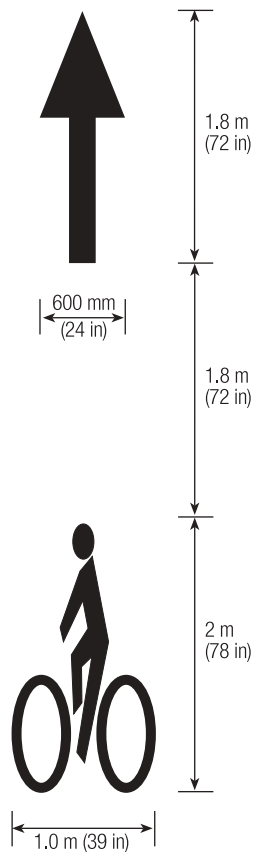

**Figure 8-12A.**  
Preferred Bicycle Lane Marking.

**Pavement Word Messages and Symbols**

Pavement word messages and symbols are used to supplement signing and longitudinal marking in bike lanes. The MUTCD indicates several allowable options for bike lane symbols. The words “BIKE”, “LANE” and “ONLY” may be used alone or in combination with the two different bicycle symbols and directional arrows. The preferred bike lane marking for use on state highways is as shown in Figure 8-12A. Symbols should be placed along uninterrupted sections of the bicycle lane using the following formula: *km/h X 7 or mph X 40*.

Bike lane symbols (or words) are intended for use only where a bike lane with associated signs is located on a highway. Bike lane symbols should not be used on paved shoulders, shared lanes or wide curb lanes.

The bike lane symbol shall be white and retroreflective. It shall be placed immediately after an intersection and other locations as needed (see Section 4.3.4, Bicycle Lane Symbols). If the preferential lane symbol is used in conjunction with other word or symbol messages, it shall precede them. The “Right Lane Bike Only” (R3-17) signs should be placed with the bike lane symbol.

The symbol shown in Figure 8-12B (Bike inside an arrow) is not an approved MUTCD pavement marking and should not be used for any bicycle facility.

**Object Markings**

At locations where objects and obstructions especially hazardous to bicyclists are adjacent to or in the path of the bicycle, MUTCD-approved object markings and or

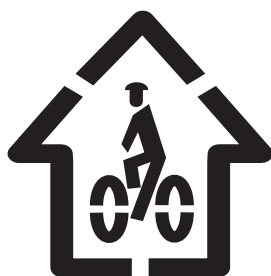

**Figure 8-12B.**  
Shared Use Lane Arrow  
This symbol shall NOT be used for any bicycle facility.

supplemental striping can be used to clearly delineate the presence of the object or obstruction.

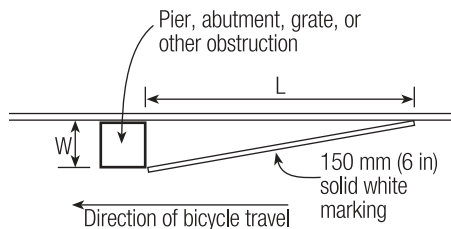

For metric units:  
 $L=0.62 WV$ , where  $V$  is bicycle approach speed (km/h)

For English units:  
 $L=WV$ , where  $V$  is bicycle approach speed (mph)

**Figure 8-13.**  
Object Marking.

This supplemental, or guide, stripe is an object marker that warns bicyclists of the presence of a hazard ahead.

### 8.3.3 Signals

Bicycles operating on roadways can be adversely affected by traffic signals. Areas of concern related to bicycles and traffic signals include:

- Demand-actuated signal systems.
- Programmable signal heads.
- Signal timing.
- Signal synchronization.

#### Demand Actuated Signal Systems

Demand actuated signal systems (i.e., signal systems that change when traffic is detected) may not respond to bicycles. To overcome this problem, employ one or more of the following techniques:

- Where bike lanes are provided, consider installation of a detector loop in the bike lane.
- Especially where no specific bike facilities are present or low traffic volumes exist, install pavement markings as illustrated in Figure 8-17 to indicate the location where the loop will be most sensitive to bicycles
- Where problems with detection are noted, adjust the sensitivity of systems that do not currently detect bicycles.
- Consider the use of new technology (e.g. infrared or video systems)

#### Bicycle Sensitive Presence Detectors

When considering the use of bicycle actuated systems, an appropriate solution depends on the particular characteristics of the intersection, the type of bicycle facility chosen and the existing signal hardware that is already in place. Possible solutions include:

- Quadrupole loop detectors.
- Diagonal quadrupole loop detectors.
- Standard loop detectors.

#### Quadrupole loop

- Detects most strongly in center.
- Sharp cut-off sensitivity.
- Used in bike lanes.



**Pavement Marking for Bicycle Sensitive Locations**

One low-tech solution to aid bicyclists in actuating a signal is to indicate the best place for bicyclists to position their bikes to trigger the signals by placing a pavement marking as shown in Figure 8-17 in the appropriate location.

For standard loops, the solid lines should be placed above the right-most wire of the loop.

For quadrupole loops, the solid lines should be placed above the center wires.

This pavement marking should be used in locations where bicyclists have indicated there is a problem with detection and it is determined that correct placement of the bicycle will solve the problem.

**Programmable Signal Heads**

Programmable signal heads may require only a simple adjustment to be visible from the viewpoint of a bicyclist, who may be positioned within a bicycle lane, near the right hand edge of the roadway, or near the right hand edge of the through travel lane. Signal visibility should be checked from these positions and adjusted accordingly.

Where programmed signals are used, adjust the signals so bicyclists on the regular bicycle lanes or travel paths can see the signals. If programmed signals cannot be aimed to serve the bicyclist, separate signals for bikes may be considered.

**Signal Timing**

Another factor related to signals that can potentially affect bicyclists is signal timing. Signal timing should include a minimum green phase that allows bicyclists to remount their bikes and travel across the intersection, and a yellow/red phase that provides a safe bicycle clearance interval. Generally, two to three seconds added to the minimum automobile green time is appropriate; a yellow interval of 3.0 s offers sufficient time for a bicyclist to come to a complete stop or enter the intersection legally; and an all-red clearance interval greater than 2.0 s is needed to clear bicycles from most intersections

The AASHTO *Guide for the Development of Bicycle Facilities* suggests that where bicycle traffic exists or is anticipated, setting the timing of traffic signals to accommodate bicycles should be considered. AASHTO provides the following guidance regarding signal timing for bicyclists.

In mixed traffic flow the bicyclist normally can cross the intersection under the same signal phase as for motor vehicles. The greatest risk to bicyclists is during the clearance interval and during the actuated phases during periods of low traffic flow. Signals should be designed to provide an adequate clearance interval for bicyclists who enter at the end of the green; and a total crossing time (minimum green plus clearance interval) long enough to accommodate bicyclists starting up on a new green.

The length of the yellow change interval is dependent upon the speed of approaching traffic. Yellow change intervals adequate for motorists (generally 3.0 s to 6.0 s) are usually adequate for bicyclists. Generally, an all red clearance interval is not required, but can be used following the yellow clearance interval. The all red clearance interval normally ranges from 1.0 s to 2.0 s. The total clearance interval (yellow change interval plus red clearance interval) can be calculated from:

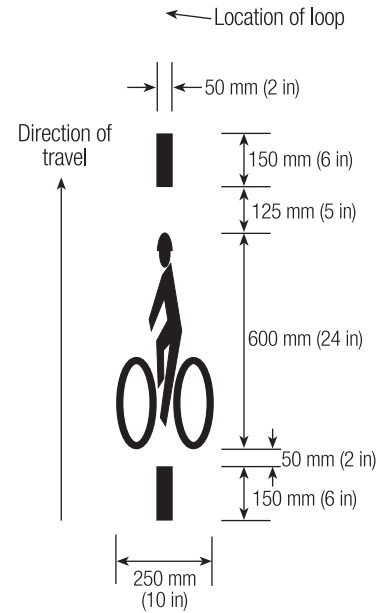

**Figure 8-17.**  
Pavement Marking to Identify a  
Bicycle Sensitive Location.

$$y + rclear \geq tr + v/2b + (w + l)/v$$

where:

y = yellow interval

rclear = red clearance interval

tr = reaction time (1.0 s)

v = bicyclist speed

b = bicyclist braking deceleration (1.2 to 2.5 m/s<sup>2</sup>)

w = width of crossing (m)

l = bicycle length (about 1.8 m)

By using a bicyclist speed of 16 km/h (10 mph), approximately 85 percent of Group B (adult basic) bicyclists can clear the intersection. If local practice does not permit a red clearance interval this long (as given by the equation), the longest red clearance interval consistent with local practice should be used.

Signal clearance intervals should be sufficient for the bicyclist to react and stop safely, or pass through the intersection on the clearance interval. The general equation to determine the minimum green time is:

$$g + y + rclear \geq tcross = tr + v/(2a) + (w + l)/v$$

where:

g = minimum green

y, rclear = yellow and red clearance intervals actually used

tcross = time to cross the intersection

tr = reaction time (2.5 s)

v = bicyclist speed (at full speed)

a = bicycle acceleration (0.5 to 1.0 m/s<sup>2</sup>)

w = width of crossing (m)

l = bicycle length (1.8 m)

However, as with all calculated signal timing, actual field observations should be undertaken prior to making any adjustments to the minimum green or clearance intervals. Acute angle intersections require longer crossing times for bicyclists.

### 8.3.4 Construction Zones and Temporary Access

Construction zones and temporary access control should be designed and implemented in accordance with Part 6 of the MUTCD. In general, where a work zone and temporary traffic controls are in place for road construction or other work operations that impact the roadway, they should provide adequate warning and provision for on-road bicyclists. In an urban area, if a work zone will obstruct access on a road with bike lanes and there is an alternate route nearby, it may be desirable to direct bicyclists to the alternate route. However, this should be done only if allowing bicyclists to proceed with other traffic through the work zone would pose especially hazardous conditions. Where alternate routes are provided for bicyclists, they must be clearly delineated with signs to ensure continuity of the route. If alternate routes are circuitous or result in significant additional distance, steep grades or additional conflicts with traffic, bicyclists may choose not to use them.

If for some reason, a detour is intended only for bicyclists, special signs should be used. (See MUTCD sign M4-9c.) Bicycle detour signs must be placed in locations where the route changes directions and periodically on long, continuous sections of the route to confirm to bicyclists that they are following it correctly. Bicycle detour routes shall not direct bicyclists onto sidewalks, unless they are of sufficient width to meet dimensional guidelines for shared use paths (refer to section 5.3.2).

## 8.4 Shared Use Paths

### 8.4.1 Signs

#### Regulatory and Warning Signs

Because shared use paths operate as facilities independent from roadways, designers should include appropriate regulatory and warning signs that conform with the MUTCD along the path corridor. Additionally, directional and information signing may be needed because shared use paths are typically separate from the road system and its signing.

The MUTCD allows regulatory and warning signs used on shared use paths to be of reduced size. Most notably, STOP signs and all warning signs have a dimension of 450 x 450 mm (18 x 18 in) When signs apply to both motorists and bicyclists they shall be the same size as used for conventional roads. The use of the smaller size signs on shared use paths results in a sign that is more in scale with the intended users of the path. In addition to the sign size, the mounting height is lower (1.2 to 1.5 m [4 to 5 ft]) than for roadway signs as shown in Figure 8-18. This also helps in having the signs serve path users well.

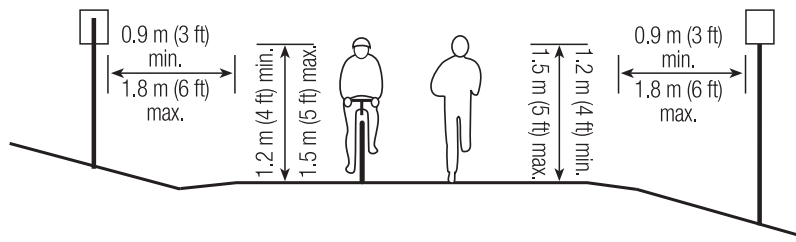

**Figure 8-18.**  
Sign Placement on Shared Use Paths.

Except for size, the design of signs for shared use paths should conform with requirements for shape, color, symbols, wording, lettering, and reflectorization as outlined in the MUTCD.

#### Guide Signs

In general, it is not necessary to use Bike Route signs on shared use paths. Bike Route signs should not be used at intersections with roads that are not designated as Bicycle Routes. Bike route signs should only be used on shared use paths in the following situations:

- Where a shared use path ends and continuity to a specific destination is provided by on-road bicycle facilities.
- At major junctions where a shared use path is part of a designated bicycle route.

#### Information and Directional Signs

As shared use paths and rail-trails stray from familiar landmarks, good signing is required to orient, inform and direct trail users along paths and trails using MUTCD Recreational and Cultural Interest signs. Other signs should direct users to and from a path or rail trail at junctions with the street system.

Safety signs and check-in stations are one of the simplest and most effective ways to promote courtesy among users of shared use paths and rail-trails because they can help convey important information quickly. Post a uniform system of operating and advisory signs at regular intervals along a path or trail. Present one message per sign and keep the message simple so it can be understood by children and adults. Repeat basic safety and operating rules such as “Bicyclists use bell or

## *Signs, Pavement Markings and Signals*

voice when passing,” “All users keep right,” and “Bicyclists yield to pedestrians.” A standard triangular trail etiquette sign assigns and informs users of preferred rights of way.

### **8.4.2 Markings**

On paved shared use paths, a 100 mm (4 in) wide yellow center line stripe may be used to separate opposite directions of travel where:

- Heavy shared use is expected.
- Curves limit sight distance.
- Nighttime riding is expected on unlighted facilities.

However, it is not standard practice to provide a centerline.

Stop lines should be used with stop signs where paths intersect roadways. The MUTCD allows stop lines to be from 300 to 600 mm (12 to 24 in) wide. Stop lines on shared use paths should be 300 mm (12 in) unless a designer determines that greater width is required for additional visibility and safety.

Pavement markings at a roadway crossing, such as crosswalk markings can serve to provide path users with additional guidance or raise motorists awareness of the crossing. Where provided, these markings should comply with the MUTCD and follow the guidance provided in Section 5.3.8, Roadway and Railroad Crossings.

### **8.4.3 Railroad Crossings**

Where paths cross active railroad tracks signs and pavement markings that meet the requirements of the MUTCD for rail crossings and the design parameters and elements of VTrans Standard Drawings, Shared Use Path Pavement Markings and Details should be installed. Reduced size versions of the Advance Grade Crossing (W10-1) and Railroad Crossbuck (R15-1) signs should be used on paths.

### **8.4.4 Construction Zones and Temporary Access**

As with other transportation facilities, it will be necessary from time to time to close or restrict access to portions of a shared use path to perform routine maintenance or repair. Because shared use paths are two-way facilities; advance warning signs telling path users what to expect ahead shall be placed on both approaches to the work zone. If the path is an accessible route of travel and there are no reasonable alternative routes (i.e. those that do not require significant additional travel distance), then access must continue to be provided. There are two ways this can be achieved.

1. Construction can be staged such that a minimum 0.9 m (36 in) clear width of path is maintained at all times.
2. A temporary path can be provided to bypass the work zone. If a temporary path is provided, care must be taken such that the transitions from the path are smooth and do not present tripping hazards or excessive gaps. The temporary surface must be smooth, firm and slip resistant. The width of the temporary path should be a minimum of 2.4 m (8 ft). The cross-slope and longitudinal slope of the temporary path shall meet ADAAG requirements.

If an alternative (detour) route is provided, it must be signed adequately. The signs must ensure route continuity and address use of the path in both directions. It must provide for the same range of users that normally use the section of path being detoured. Selection of the alternate route must consider factors such as adjacent motor vehicle traffic, provision for bicyclists and pedestrians at road crossings, surface conditions and accessibility of sidewalks. It is not recommended to detour



shared use path users to a sidewalk that has inadequate width for use as a shared use path (see Section 5.2.5 - Avoid the Use of Sidewalks for Shared Use Paths).

## ***8.5 School Areas***

Part 7 of the MUTCD discusses school routes, crossings, signs, markings, signals, and other considerations. VSA Title 19, Sections 921 and 922 address school zone signs; Section 922a describes when special signs for the disabled can be installed.

## ***8.6 Additional Resources***

- *Accessible Pedestrian Signals*, Billie Louise Bentzen and Lee S. Tabor, U.S. Access Board. August 1998. This and other publications available at <http://www.access-board.gov/indexes/pubsindex.htm>.
- *Guide for the Development of Bicycle Facilities*, American Association of State Highway and Transportation Officials (AASHTO), Washington, DC. 1999.
- *Manual on Uniform Traffic Control Devices*, Millennium Edition, Federal Highway Administration, Superintendent of Documents. P.O. Box 371954, Pittsburgh, PA 15250-7954. 2000.
- *Pedestrian Traffic Control Signal Indications*, ITE. 1985 edition.
- *Safety Effects of Marked vs Unmarked Crosswalks at Uncontrolled Locations*, Charles V. Zegeer, et al., UNC Highway Safety Research Center for the Federal Highway Administration. November 2000.



CHAPTER 9:



# Landscaping and Amenities

## *Contents*

9.1 Introduction .....	9-2
9.1.1 Applicable Guidelines and Standards .....	9-3
9.2 Landscape and Amenities Design Considerations .....	9-3
9.2.1 Village, Urban and Rural Settings .....	9-3
9.2.2 Constraints and Issues .....	9-5
9.3 Maintenance .....	9-7
9.4 Shared Use Paths and Rail Trails .....	9-8
9.5 Amenities .....	9-9
9.5.1 Lighting .....	9-10
9.5.2 Trash Receptacles .....	9-10
9.5.3 Information and Directional Signing .....	9-10
9.5.4 Benches and Street Furniture .....	9-11
9.5.5 Trailheads and Trailhead Parking .....	9-11
9.5.6 Information Kiosks .....	9-11
9.5.7 Drinking Fountains .....	9-12
9.5.8 Public Telephones .....	9-12
9.5.9 Bus Stops and Transit Shelters .....	9-12
9.5.10 Distance Markers .....	9-13
9.5.11 Bicycle Parking .....	9-13
9.5.12 Public Restrooms .....	9-15
9.5.13 Picnic Tables and Protective Shelters .....	9-15
9.5.14 Stairways .....	9-15
9.5.15 Other Amenities .....	9-15
9.6 Additional Resources .....	9-15

## *Figures*

9-1 An Example of Planting for Town/Village Arterial in an Urban Setting .....	9-4
9-2 Landscaping on a Shared Use Path .....	9-9
9-3 Spatial Requirements for Bicycle Parking Devices .....	9-14
9-4 Clearances for Parallel-Loading Racks .....	9-14
9-5 Commonly Accepted Minimum and Recommended Clearances for Pedestrian Movement and Bike Parking .....	9-14

## *Tables*

9-1 An Example of Planting for Town/Village Arterial in an Urban Setting .....	9-4
--	-----



## 9.1 Introduction

*The source of much of the information in this chapter is the VTrans Landscape Guide for Vermont Roadways and Transportation Facilities (2001)*

Street trees, plantings and other amenities have long played a role in Vermont's transportation network. Historic photos often show tree-lined streets and shady town commons.

Although transportation has greatly changed in the last century, many communities want to retain the historic landscape elements that enhance their roadways.

However, it is essential that landscaping and amenity maintenance considerations be considered during the planning stages of a project to ensure that a capable maintenance entity is identified and the full cost of maintenance activities are considered before embarking on many of the types of improvements described in this chapter. In addition to quality of life benefits, landscaping and amenities also have significant transportation and economic advantages:

- *Safety.* Formal rows of trees and gateway signs at an entrance to a community change the road's visual character, alerting drivers that they are entering a settled area. Used in conjunction with curbs and sidewalks, trees help to calm traffic. Street lighting, particularly at pedestrian and bicycle facility street crossings, also enhances driver awareness of other roadway users.

- *Wayfinding.* Roadside trees or groups of trees, lighting, fountains, statuary and other amenities can also serve as landmarks and even alert drivers of an upcoming turn in the road. Landscaping in a traffic island or roundabout makes the feature more recognizable to approaching drivers.

- *Multimodal.* Trees, benches, drinking fountains and transit shelters add to the comfort of exterior spaces. Collectively they can soften harsh light, provide opportunities for rest and refreshment in the summer, and offer protection from the elements.

- *Variety.* Monotony discourages walking and bicycling, and causes driver inattention. Trees and amenities create attractive visual interest that give the road a distinctive identity and provide seasonal interest.

- *Environmental.* Trees absorb pollutants and storm runoff, reduce air conditioning needs in the summer, and can help block winter winds. Shrubs can also be used as snow or sound blocks.

- *Business Vitality.* People enjoy and are attracted to an environment with trees, landscaping and other pedestrian and bicycle amenities. They are more likely to stay and shop in a downtown with tree-lined streets and there is evidence that they will pay more for both residential and commercial land on streets with mature trees and other amenities.

East Poultney



Burlington



Manchester



Lyndonville



Old photos show that tree-lined streets have long played a role in Vermont's transportation network.

### 9.1.1 Applicable Guidelines and Standards

The *Landscape Guide for Vermont Roadways & Transportation Facilities*, prepared for VTrans by the Vermont Chapter of the American Society of Landscape Architects, January 2001, recommends landscaping practices and prototypes suitable for the various roadway conditions outlined in the Vermont State Standards and also recommends landscaping for sidewalks, shared use paths, park-and-ride lots and other transportation facilities. It also features an extensive bibliography of additional resources.

The *Vermont State Standards for the Design of Transportation Construction, Reconstruction and Rehabilitation on Freeways, Roads and Streets*, 1997, describes design parameters that allow sensitivity to the local context.

*Vermont Standard Drawings* LS-1 (Landscaping Treatment Details) and LS-2 (Landscaping Notes) provide planting details for trees and shrubs and related design considerations regarding landscaping.

#### VTrans Policy on Transportation Enhancement Activities – 11/22/02

The VTrans Policy on Transportation Enhancements provides for both a free-standing enhancement program and enhancements to traditional transportation projects. The policy states that expenditure for the freestanding program is equal to 10 percent of the Vermont apportionment of the Surface Transportation Program (STP). Enhancements to traditional transportation projects will emerge through the project scoping and design process. Expenditures will be limited to not more than 10 percent of the underlying project cost at the semi-final plans stage.

## 9.2 Landscape and Amenity Design Considerations

### 9.2.1 Village, Urban and Rural Settings

The Vermont State Standards distinguish between urban and village settings and rural settings within each roadway classification. Landscape design should reflect these distinctive roadway settings. An example of an urban or village arterial is shown in Figure 9-1. Refer to the *Landscape Guide for Vermont Roadways & Transportation Facilities* for other settings.

Landscape and amenity design for urban and village settings, in all roadway classifications, will likely follow a more traditional, formal pattern of street tree plantings and landscaped greens and islands. Landscaping in rural settings will tend to be more informal and naturalistic. On many rural roadways no planting at all is needed if the project fits well into its surroundings and suitable indigenous plantings remain or revegetation of native species will naturally occur on cleared areas and embankments. However, landscaping may be useful in stabilizing slopes and preventing erosion.

There may be greater opportunity to use right-of-way space for street tree planting in a urban or village setting if the speed limit is set at 40 to 48 km/h (25 to 30 mph). Lower traffic speed allows for narrower lane widths, shoulder widths, and clear distances as well as better conditions for pedestrians and bicycles. When curbs are installed, trees and amenities can be planted/installed nearer to the traveled way.

Street trees are typically spaced and amenities installed evenly along a street, ranging from 7.5 to 15 m (25 to 50 ft) apart, but the green strip does not have to be continuous. Green strips can be omitted where obstructions occur. Parallel parking



**“Given a limited budget, the most effective expenditure of funds to improve a street would probably be on trees.”**

-Planner Allan B. Jacobs

#### Terminology

**Amenity:** a feature or object placed within or close proximity to a public space that increases the usefulness and user enjoyment of a public facility or space (e.g., street furniture, trash receptacles, trailhead, parking, transit shelter, lighting, public restrooms and drinking fountains).

**Historic tree:** a tree of notable interest because of its age, type, size, or historic association.

**Landscaping:** modification of the natural environment by any grading, drainage, erosion control, roads, walks, screening, planting, and lighting.

**Planting:** a group of plants or trees.

**Green strip:** a long thin area or greenbelt prepared for vegetation, usually between the roadway and sidewalk or in a median.

**Street trees:** trees grown primarily for use along roads and streets, usually limbed up to 2.4 m (8 ft).



is often needed to serve local businesses located along part of the roadway. Parallel parking can be substituted for the green strip in front of some businesses or for extended sections of road frontage. Green strips should not be installed between parallel parking lanes and a sidewalk where heavy pedestrian traffic is anticipated.

## 9.2.2 Constraints and Issues

Locate landscaping with the safety of drivers, pedestrians and bicyclists in mind. Consider other elements of the road or path as well as the following factors when choosing the type and location of landscaping to be used.

### Sight Lines

Sight distances recommended by AASHTO limit the use of landscaping in areas where the driver's view of oncoming cars, signs and traffic control devices must be maintained. Sight distances increase with the design speed of the road.

At intersections the visibility of crosswalks is particularly important. Shrubs that grow over 1 m (3 ft) in height or trees with thick trunks or low branches may restrict visibility. Sight distances recommended by AASHTO often conflict with traditional village tree-lined streetscape designs. In resolving these conflicts, it is important for engineers and the public to understand that street trees come in many shapes and forms and do not always block sight lines if selected with care.

Some nurseries grow trees especially for use as street trees. Such trees have clear stems (no branches on the trunk) to heights of 1.8 or 2.1 m (6 or 7 ft). The branchless trunks allow clear visibility below the tree canopy for drivers of most vehicles. As trees mature, the lowest branches can be removed to raise the canopy further.

Consider each site and situation individually. Evaluate the possibility of lowering a road's design speed through a village setting to reduce the sight distance requirements and allow more planting flexibility. Consider moving the corner out into the roadway by installing curb extensions to improve sight distance without requiring tree removal.

Shared use paths require at least 3.0 m (10 ft), with a minimum 2.5 m (8 ft), of "head room" above the pavement that is clear of obstructions, including branches. However, where equestrian or snowmobile grooming equipment is expected a 3.5 to 3.7m (10 to 12 ft) overhead clearance is desired. Walkways require a minimum of 2.4 m (8 ft) vertical clearance from the ground to continuous overhead obstruction. A minimum clear vertical distance of 2.1 m (7 ft) is required at spot obstructions.

### Clear Distance

Landscaping must be set back from the roadway a sufficient distance to avoid creating a hazard for cars that swerve off the road. In an urban or village setting where roads are curbed, landscaping should be located at least 1.2 m (4 ft) from the curb.

Plantings must also accommodate other elements within the roadway corridor such as signs and signals. The placement of some signs (warning and advisory) may be somewhat flexible while the placement of most regulatory signs and traffic signals will be strictly prescribed. The minimum vertical clearance between the bottom edge of roadway signs and the finished grade is 2.1 m (7 ft).

The Vermont State Standards prescribe minimum clear zone setback criteria for curbed and uncurbed roadways. These standards should be applied to all new tree plantings whose trunk diameter at maturity will be 15 cm (6 in.) or greater. Setback distances or vehicle recovery areas are related to type of slope, slope ratio, functional

classification of the roadway, and design speed of the highway. Setbacks are measured from the “traveled way,” which is the portion of the roadway used for vehicle travel, exclusive of shoulder and auxiliary lanes.

Variations in site-specific conditions need to be considered and may warrant special treatment. Existing historic, aesthetic or environmentally important trees may be retained within the recovery area if they are protected or are not in a target position, such as the inside of a horizontal curve. Low shrubs and ground cover may be planted in the recovery area for safety and aesthetic purposes. However, designing to less than a minimum value should be done only as a “last resort” and the decision to do so should be well documented and supported, where required, by an approved design exception.

### **Lighting**

Locate trees to accommodate the placement of light fixtures and the recommended illumination levels of the road and sidewalk. Consider pole heights, light cones, the shape of the tree, and the horizontal location of poles relative to tree stems to determine the illumination and landscaping.

### **Underground Utility Conflicts**

In a village setting it is preferable to have a green strip dedicated solely to growing trees. Given the limited right-of-way in most urban areas and villages, that is rarely possible. As a result, there are at least two concerns often cited where underground utilities share a green strip.

One concern is the potential for root systems to invade water and sewer pipes. In Vermont, water and sewer lines are usually located below the frost line (usually a minimum of 1.2 m [4 ft] deep), which is well below the normal depth of most tree roots. Under normal conditions tree roots grow within 45 cm (18 in.) of the surface, primarily to obtain oxygen. Only in rare cases (when denied access to water) do tree roots dive to seek available moisture and nutrients from a cracked pipe or leaking joint. New, well-sealed utility systems located below trees in a green strip that are provided with sufficient moisture and nutrients should not experience this problem.

A second concern is locating trees in a green strip above existing underground utilities, which may someday need to be excavated for repair or replacement. This concern may be unfounded for the following reasons:

- Such excavations are very infrequent.
- While in place, the urban tree provides many welcome benefits so placement of either trees or underground utilities should not be deterred.
- If excavation becomes necessary, the cost of replacing a tree or group of trees is relatively low.

Often, gas lines and other small utility pipes can be routed below the root system. This practice of horizontal boring and “jacking” pipes can be used for pipes up to 25 cm (10 in) diameter. Blanket regulations concerning trees and underground utilities should be avoided and each installation considered individually. Often the decision will consider the immediate and long-term costs and the value a town or municipality may place on having a tree-lined roadway.

### **Overhead Utility Conflicts**

The increased use of phone and cable makes utility wires more prominent than ever. Street trees can effectively help screen utility poles and wires or at least distract



from their presence. To prevent damage, trees sharing the utility belt must be planted so that branches do not interfere with wires.

Small trees under utility wires are not generally recommended. Although trees that do not exceed 3 to 4.5 m (10 to 15 ft) may be appropriate for some roadway settings, they may be out of scale along most highways. In addition, if pruning the lower branches of small trees is required to make way for passing trucks on the roadway and pedestrians and snowplows on the sidewalk, the upper crown of the tree is further reduced. These small, misshapen trees have few of the benefits associated with large street trees. Small trees also have a shorter life span than larger trees, making larger trees a better investment.

Try to use trees that will have a mature height of 7.5 to 9 m (25 to 30 ft). The small upper branches of these trees may brush the wires and if necessary can be pruned, but the heavy limbs capable of breaking wires remain well below wires. The slightly larger trees have enough size and presence to visually compete with the width of the roadway and adjacent buildings. As trees mature they form a canopy over the sidewalk and road, diverting attention from overhead utilities. They also provide a wider canopy and more shade.

Another option is to plant trees with an open crown that can be “crotch pruned” to avoid the wires. This has been a common practice, and the results can be seen in many towns that have older mature trees planted under utility lines. From some angles the distorted crown of the tree is apparent, but pedestrians and drivers below still enjoy the shade of the lower branches and the canopy of the tree-lined street.

Many varieties of columnar shade trees have been developed that include types suitable for street trees. These varieties, which have tall, narrow crowns, may be useful in some locations where overhead utilities exist and the right-of-way is narrow. Columnar trees have their place but do not provide the shade and canopy of a tree with a full crown.

### **Shade and Freezing**

Trees planted close to the roadway should be of a deciduous salt resistant species. Such trees do not create heavy winter shading that allows the roadway to freeze sooner and thaw later. Even large deciduous trees can have some effect on freeze and thaw cycle.

## ***9.3 Maintenance***

Landscaping requires maintenance to keep plants in good condition, to trim vegetation and to remove debris. Vegetation that encroaches into a roadway, bikeway or walkway is both a nuisance and a safety problem. Roots need to be controlled to prevent them from heaving the sidewalk. Adequate clearances and sight-distances need to be maintained at driveways and intersections. Pedestrians and bicyclists must be visible to approaching motorists, rather than hidden by overgrown shrubs or low-hanging branches, which can also obscure signs and other traffic control devices.

State law enables each town to appoint a local tree warden whose role it is to advise communities on care of street trees and town forests. Towns vary on how they use this position. Although the tree warden does not have legal authority within the state right-of-way, he or she can play an important role as an advocate for street trees and the “urban forest.” Some towns have citizens’ groups that fulfill this role.

Planning for the maintenance of new landscaping should be part of the initial project planning process. Long-term maintenance is almost always the job of a

town, which should have a clear understanding of the scope of work required and be willing to accept the added responsibility and cost. Typical needs are:

- *Street trees.* Street trees require pruning every 5 to 7 years. Watering may be required in the first few years or during a particularly dry year. A fund should be established to replace trees that fail over time.
- *Median planting.* Low plantings of shrubs or perennials in medians or islands need weeding (3 to 4 times per growing season) for about the first 3 years until they establish a dense cover. After that, yearly weeding should be sufficient. Planted island medians may also need to be mowed and kept clean of roadside trash and debris.
- *Naturalized planting.* Shrubs, evergreens and trees planted in rural areas should be designed to blend into existing native vegetation and should be selected for their ability to survive roadside conditions and low maintenance.
- *Leaves, needles, fruit and twigs.* All plantings drop leaves, needles, fruit or twigs. Some of these may end up on roadways, bikeways or sidewalks or in drainage catch basins. They can become a slipping hazard when wet or compacted. In many towns the green strip is maintained and the adjacent property owner rakes the leaves. Leaves mowed to a fine texture can also become mulch that fertilizes the green strip. A town staff, volunteer garden club or civic organization can assume responsibility for the care of medians and green strips.

VTrans agreements with contractors require maintenance of landscaping until plantings are accepted (usually after two inspections at 30 and 60 days). Such contracts also require that plants be guaranteed for one year. One year after construction, a responsible party such as a municipality or a garden club, may take over responsibility for maintaining all plantings. VTrans requires a signed Finance and Maintenance Agreement or Cooperative Agreement that ensures a commitment by the community and allows work in the state right-of-way.

Local ordinances can ensure that vegetation on private property is regularly maintained. Some jurisdictions require landowners to control vegetation along a highway. Where vegetation is not controlled, some jurisdictions have maintenance personnel perform the work and bill the property owner. The key to quality landscaping is in choosing the appropriate materials and maintenance. Property owners must participate in both aspects. What drives the success is the shared social expectation that taking care of the streetscape is the responsible thing to do. A shared expectation also shows that both the town and property owners care about their community.

## ***9.4 Shared Use Paths and Rail Trails***

Plantings can benefit shared use paths and rail trails in many of the same ways that they benefit roadways. They add shade, add screening, frame views, define the direction of the path, provide protection from falls and enhance the path in many more ways.

Shrubs can be used in conjunction with fencing to create barriers where needed to control flow or provide a safety barrier at the top of an embankment. Landscaping and trees placed along paths need to be carefully selected to avoid the need for excessive pruning, cleanup of fallen fruit and debris, and watering. Avoid trees and shrubs with shallow root systems (such as cottonwoods) that have a tendency to raise and buckle surrounding pavement areas; otherwise, install root barriers as needed. Soil sterilants can also be applied to prevent vegetation from erupting through the pavement.

Locate all posts and barriers, including tree stems, a minimum of 0.9 m (3 ft) from the traveled way of a path. Overhead branches should be a minimum of 2.5 m (8 ft) away, but 3.0 to 3.6 m (10 to 12 ft) is recommended to accommodate equestrians and snowmobile grooming equipment as well as maintenance and emergency vehicles.

Rail trails can sometimes be visually monotonous. Visual interest can be enhanced through selective clearing of existing vegetation to open up views of the surrounding countryside.

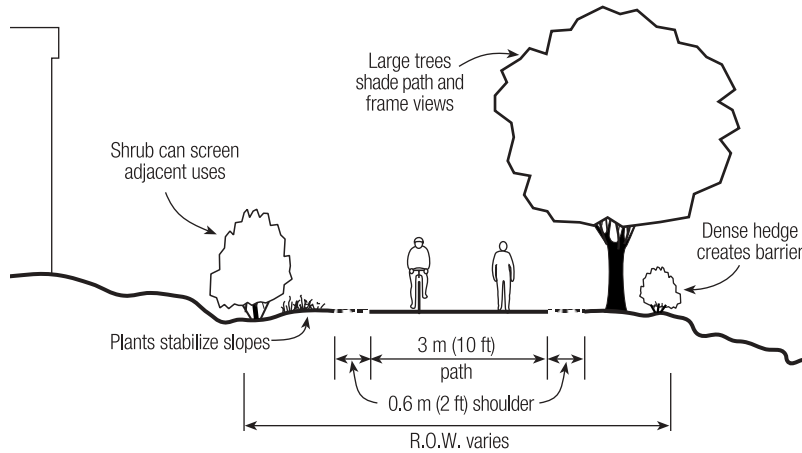

**Figure 9-2**  
Landscaping on a Shared Use Path

## 9.5 Amenities

Because pedestrians and bicyclists travel using their own power, it's important to provide opportunities for them to rest, to shield themselves from the weather or sun, to refresh themselves with a drink of water or to provide an illuminated route of travel. Therefore, amenities that provide these benefits should be considered and included as essential components of every project.

Consider these items to further improve comfort, sense of security and convenience of bicyclists and pedestrians:

- Lighting.
- Trash receptacles.
- Information and directional signing.
- Benches and street furniture.
- Trailheads and trailhead parking.
- Information kiosks.
- Drinking fountains.
- Public telephones.
- Transit shelters.
- Distance markers.
- Bicycle parking.
- Restrooms.
- Picnic tables and protective shelters.
- Ramps and stairways.



**Amenities that allow pedestrians and bicyclists to utilize and enjoy facilities to a high degree should be considered and included as essential components of every project.**

Montpelier



Lighting permits use of a facility during twilight and nighttime hours.



Consider the nature of the surroundings and environment when deciding to use or not use trash receptacles and other street furniture.

Middlebury



Signs can assist visitors and residents to find appropriate routes on foot.

Consider these items to soften and enhance the pedestrian and bicycle environment:

- Grassy areas and buffer strips.
- Shade trees.
- Planters.
- Textured walkway surfaces.
- Statuary or artwork (sculpture, etc.).
- Ornamental fountains.
- Selective relocation of utility poles or burial of utility cables.
- Up lighting of trees, monuments and gazebos.

Newport



### 9.5.1 Lighting

Consider the need for lighting on paths used by commuters or college students during twilight and nighttime hours and for any path at a street crossing. Special consideration should be given to lighting at pedestrian street crossings. Fixed-source lighting improves visibility along paths and intersections, and allows users to see the path direction, surface conditions and obstacles. Lighting should also be considered in underpasses, overpasses and tunnels and where nighttime security could be an issue.

Depending on the location and surrounding lighting conditions, average maintained horizontal illumination levels typically range from 5 lux to 22 lux. Where security problems are perceived, higher illumination levels may be appropriate. Light standards (poles) should conform to the clearance dimensions as described throughout this manual. Luminaries should be cutoff-type fixtures to minimize glare and obtrusiveness to surrounding areas. Standards should be sized as appropriate for pedestrian walkways.

Refer to “Outdoor Lighting Manual for Vermont Municipalities,” CCRPC, 1996, for guidance on how to identify exterior lighting issues, basic lighting concepts, and to set lighting standards.

### 9.5.2 Trash Receptacles

The decision to provide trash receptacles should take into account the nature of the surroundings and environment as well as the ambiance and ethic that is desired. A well-enforced “pack-in and carry-out” philosophy works well at state parks and could also reduce maintenance along shared use paths and rail trails.

### 9.5.3 Information and Directional Signing

Pedestrian-oriented signs should be developed for urban and village areas to assist visitors and even residents who may not realize that the best route on foot is shorter than what they are used to driving. Examples of key destinations to include are libraries, post offices, government offices, transit centers, schools, museums, entertainment centers, shopping districts, parks, public rest rooms, and tourist attractions.

Signs should be unobtrusive, easy to read, aesthetic, and consistent with local and state (where applicable) specifications (e.g., symbols, design themes, etc.). Place only enough signs to lead a pedestrian confidently to the destination by the best route. Avoid adding clutter to the streetscape by clustering signs in strategic locations on a single post where possible. Distances should be given in blocks, average walking time or other measurements meaningful to pedestrians and bicyclists.

### 9.5.4 Benches and Street Furniture

Signs, street furniture, and other items that could be considered obstacles should be placed outside of the Pedestrian Thought Zone as discussed in Section 3.3.1, Facility Characteristics, with clearances as specified in Section 3.4, Sidewalks. All items installed for pedestrian use should be accessible.

In urban and village settings, provide benches in parks and shaded locations. Disabled and elderly pedestrians appreciate benches at regular intervals along all public streets, especially where sidewalks slope steeply. Benches should be placed on level, paved surfaces. Widen sidewalks and utilize curb extensions to keep benches outside of the pedestrian traffic stream.

Pedestrians with disabilities prefer seating with a fairly high seat, a shallow front-to-back dimension, a supportive back, and armrests that enable them to make the transition between sitting and standing.

### 9.5.5 Trailheads and Trailhead Parking

Where possible locate shared use path and rail trail access points in developed areas and where people tend to congregate such as shopping centers, public parks and residential developments. Support facilities may already be in place and safety may be enhanced in populated areas. These areas may also be more readily accessible to emergency services and maintenance facilities.

Connect access points to the bicycle and pedestrian transportation network. Access to transit is also important and will increase use of a path or trail facility. Where public support facilities do not already exist, trailheads should include public vehicular parking, bicycle parking, trash receptacles, restrooms, and public telephones, where applicable. An information kiosk (or even a simple bulletin board) containing a map of the path or trail will greatly add to the convenience and enjoyment of path users.

Provide adequate parking for motor vehicles at roadway access points. Vehicular circulation should be logical and avoid conflict with non-motorized users. Where the number of off-street parking spaces cannot be easily determined from existing facilities, use ITE (Institute of Transportation Engineers) guidelines.

Where equestrian or snowmobile use is anticipated, provide parking for motor vehicles pulling trailers. Such spaces should be at least 13.5 m (45 ft) long — 10.5 m (35 ft) for the motor vehicle and trailer plus 3 m (10 ft) to unload horses or snowmobiles — and 4.5 m (15 ft) wide (to accommodate horses tied to the trailer where tack and feed may be stored. Parking for trailers should be of the drive-through type so backing is unnecessary. If the parking area is to be paved, provide an unpaved standing area for horses adjacent to a trail entry.

Sheet flow drainage is preferred for parking lots. Locate space for snow storage so it does not conflict with any other activity or use.

### 9.5.6 Information Kiosks

Because pedestrians and bicyclists expend their own energy getting to a destination, it is important to maximize wayfinding opportunities to reduce the possibility of out of direction travel. In addition, destinations



#### Benches

- 485 mm (19 in) seat height.
- Shallow front-to-back dimension, about 610 mm (24 in).
- Supportive back.
- Armrests (for ease in sitting and standing).
- Level base.

#### Street Furniture

- 915 x 1220 mm (30 x 48 in) clear ground area at the item.
- Unobstructed reach range to highest operable part:  
*Forward* — 1220 mm (48 in) high maximum, 380 mm (15 in) minimum or  
*Side* — 1370 mm (54 in) high maximum, 230 mm (9 in) minimum.
- Operating force no greater than 22.2 N (5 lbs).
- Hardware operable with one hand without tight grasping, pinching, or twisting of the wrist.
- Knee room 685 mm (27 in) high, 760 mm (30 in) wide, 485 mm (19 in) deep where necessary for use.

### Drinking Fountains

- Install “hi-lo” drinking fountains for accessibility.
- Avoid projecting into circulation route.
- Provide accessible controls.

### Telephones

- Highest operable parts within reach range.
- Volume control and hearing aid compatible.
- TTY capability.

### Bus Stops and Transit Shelters

- 244 cm (96 in) long x 152 cm (60 in) wide minimum.
- Slope same as roadway.
- Accessible route to and into shelter.
- Clear floor space, 76 x 122 cm (30 x 48 in) fully within shelter.
- Legible signing.

that are familiar to a resident may be unknown to a visitor. Frequently spaced information kiosks and directional signs can alleviate these problems and make the environment more inviting to walking and bicycling. Where provided, locate information kiosks and directional signs adjacent to but outside the Pedestrian Through Zone.

### 9.5.7 Drinking Fountains

Wheelchair-accessible and standing-height drinking fountains should be combined when installed on public sidewalks and paths. Both drinking fountains and telephones need to be carefully located to avoid projecting into a circulation route. Note that the minimum knee room required for a drinking fountain — 69 cm (27 in) — is also the maximum height at which a projection over the sidewalk will be detectable by a pedestrian using a cane. Because paths are often developed in separated rights of way, access to potable water is very important along shared use paths, especially during warm weather months.

### 9.5.8 Public Telephones

Where public pay telephones are grouped in a public space, at least one instrument should be installed at a wheelchair-accessible height while another should be mounted higher to enable pedestrians who have difficulty bending or stooping to use it easily. Exterior telephones can now incorporate a text telephone (or TTY) for non-voiced communications, as well, so that a single unit can provide access to most users. If only one telephone is provided, it should be wheelchair accessible. All voice instruments intended for outdoor installations should have volume controls (routinely provided today) and be hearing aid compatible. Additional information is available from the U. S. Access Board publication “Bulletin #3: Text Telephones.”

### 9.5.9 Bus Stops and Transit Shelters

At bus stops, transit stations and other locations where pedestrians must wait, a shelter makes the wait more comfortable.

Shelters should provide undercover seating including enough space for wheelchairs. Always erect transit shelters on a paved surface and connect the transit shelter to the pedestrian network via a paved walkway. Enclose three sides of the shelter to provide maximum weather protection. Provide windows or use transparent material on the sides of the shelter for maximum visibility and security. Illuminate the shelter and area around the shelter for nighttime use. Post weather-protected up-to-date bus schedules and route maps within each shelter.

Transit stops are considered pedestrian walkways and require curb ramps. Because parked cars, traffic, and other conditions may make it difficult for a bus to pull up alongside a curb for its full length in order to deploy a lift or ramp, a bus stop should be served by a curb ramp so that a passenger may board or exit in the roadway when necessary. Curb ramps at the intersections where the bus stop is located will usually satisfy this requirement, although a curb ramp at the stop may be needed in some locations, particularly at midblock stops.



Transit shelters protect users from the weather and make waits more comfortable.

When locating transit stops, consideration should be given to placing the stop on the far side of an intersection instead of on the near side of an intersection. For pedestrian safety and maximizing sight distance at intersections, far side stops are preferred.

**9.5.10 Distance Markers**

Provide kilometer or mile markers to aid emergency rescue and to orientate path users. Distance markers are especially beneficial to those engaged in fitness activities. When used in conjunction with a rail trail use both trail and historic railroad milemarkers. Distance markers take many shapes and forms. The most common and preferred design for Vermont includes a 100x100 mm (4x4 in) pressure treated wooden post 1.8 m (6 ft) in length with 50-100 mm (2-4 in) letters/numbers incised (routed) in the post. Bury posts 0.9 to 1.2 m (3 to 4 ft) in the ground. Install posts in concrete where vandalism is a concern.

Derby – Beebe Spur Rail Trail



Distance markers can aid emergency rescue and orientate path users.

**9.5.11 Bicycle Parking**

Lack of secure parking facilities is frequently cited as a deterrent to bicycling in urban or village settings. People may avoid bicycling when:

- There is no place to park their bicycles at their destination.
- They perceive their bicycle or components may be subject to theft or vandalism or they have to walk too far to a building’s entrance.
- Their equipment will be exposed to weather.
- The parking area is poorly lit or perceived as unsafe.

In addition to the guidance provided in this manual, users of this manual are encouraged to consult *A Guide to Bicycle Parking Facilities* published by VTrans in 2000 for a complete discussion of rack siting considerations, rack types and contact information for rack manufacturers.

The principle considerations for bicycle parking are:

- Appropriate level of security required for the anticipated parking period.
- Location of the bicycle parking area.
- Spatial requirements.
- Signing and identification of the parking area and devices.

**Appropriate levels of security and parking periods.** Bicycle parking decisions begin with consideration of the level of security desired to protect the bicycle against theft, vandalism and weather, which is strongly influenced by the length of time the bicycle will be parked.

**Location.** Because bicycles literally provide door-to-door transportation, bicyclists look for parking areas nearest a building’s entrance. If a bicycle parking area is inconveniently located elsewhere, bicyclists will not use the parking that has been provided and will park near an entrance anyway, possibly locking their bicycle to some other fixed object such as a tree, handrail, or fence.

- Select a bicycle parking facility that will best meet the needs of the intended users (i.e., bike lockers for long-term secure storage, racks that secure the frame and wheels for mid-term storage, or leaning rails for short-term storage).
- Where the need for bicycle racks is indicated, select a rack type that supports both the frame and wheel(s).
- Locate bicycle parking in a clearly visible area as close to a principal building entrance as possible.
- Install bicycle parking devices over a hard paved surface that drains rainwater away from the parking area.

1



2



3



Select bicycle parking devices according to the need of the users and level of security required: 1) lockers for long-term secure storage, 2) racks that secure the frame and wheels for mid-term storage and 3) leaning rails for short-term low-security storage.

- Separate bicycle parking facilities from vehicular parking and driveways by a barrier or buffer area to prevent damage to the parked bicycles.
- Ensure that all facilities are adequately illuminated and visible from adjacent sidewalks or parking lots.
- In densely populated areas such as office parks, village centers, and colleges and universities, covered bicycle parking can protect bicycles as well as arriving and departing pedestrians from the elements.

**Spatial requirements.** Provide sufficient space on a hard, paved surface for access, maneuvering and storage. Each bicycle should be accessible without moving another bicycle.

Because most bicycle parking devices come in single or double units, a small number of parking units can be installed at first with additional units added incrementally as the demand grows. However, the total “built-out” area of the bicycle area should be taken into account from the beginning so that there will be adequate room for expansion.

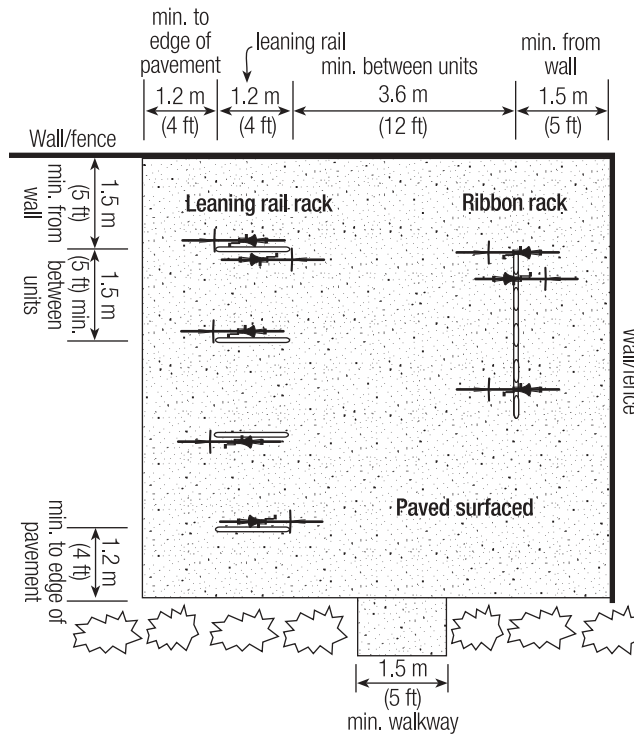

Figure 9-3.

Spatial Requirements for Bicycle Parking Devices.



Leaning rails can be added incrementally as demand for parking space grows.

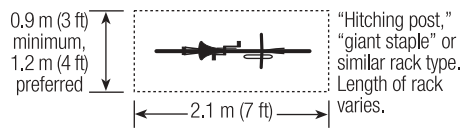

Figure 9-4.

Clearances for Parallel-Loading Racks, one or two bikes per rack, depending on rack type and spacing.

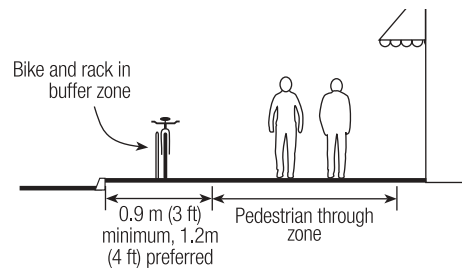

Figure 9-5

Commonly Accepted Minimum and Preferred Clearances for Bike Parking on sidewalks. Note that sidewalk widths of less than 2.4 m (8 ft) will not accommodate bike racks.



**Signing and identification.** Signs that direct bicyclists to bicycle parking areas also let people who drive to work know that bicycle parking is available. However, avoid the use of complicated signing schemes. Refer to Chapter 8, Traffic Control Devices, for examples of signing.

The best bicycle parking devices need no operating instructions. However, use of parking devices may often be encouraged if an image of a bicycle is associated with the device in some manner.

### 9.5.12 Public Restrooms

Conveniently located restrooms are welcomed by both residents and tourists and take the pressure off business owners from having to provide sanitary facilities for the general public.

Where provided, public restrooms and portable toilet facilities on a site or in the public right-of-way should be accessible. At least one unit in each cluster should meet ADAAG. Many of the units that are currently manufactured do not meet accessibility criteria, particularly with respect to turning space. Agencies responsible for the temporary rental of such facilities should compare portable toilet unit specifications with the requirements for handicap accessibility.



### 9.5.13 Picnic Tables and Protective Shelters

Shelters and picnic tables with roofs and protected seating areas are well received by users, particularly on rail trails where there tends to be greater exposure to the sun and other elements because of the necessity to keep the corridor free of trees and other vegetation. Locate shelters and picnic tables well back from the trail, preferably on the side of the trail that is most scenic (where a choice exists). Consider a shelter's use in winter and locate windbreak screens toward the prevailing weather patterns.



Conveniently located restrooms are welcomed by both residents and tourists.

### 9.5.14 Stairways

Where a connection is needed to a destination or another path at a different elevation, a stairway can be used where the terrain is too steep for a path. To accommodate bicyclists, a 75 mm (3 in) groove (wide enough to accept a bicycle tire) can be provided in the top of the stringer on both sides of the stairway so bicyclists can easily guide their bicycles up or down the stairway.

Because stairways do not meet ADAAG requirements for accessible routes of travel, the destination should also be accessible along a more level alternate route, even if that route is longer and more circuitous.

### 9.5.15 Other Amenities

Other items commonly found on sidewalks and along paths — fire pull stations, mailboxes (including curbside receptacles for overnight delivery services), information and sales kiosks, and fixed vending machines — should meet basic accessibility requirements for approach, reach range, and operating force and control. The placement or installation of such items should not narrow the minimum clear, unobstructed sidewalk and path width. Particularly at turns, access points and ramps and in places that require additional maneuvering space.

Burlington



Where bicyclists need to change elevation using a stairway, provide a groove wide enough to accept a bicycle tire along the top of the stringer on both sides of the stairway.

**Public Restrooms**

- Each toilet room accessible.
- Accessible fixtures and fixture spaces.
- Grab bars.
- Maneuvering space at doors.
- Accessible hardware and accessories.

## 9.6 *Additional Resources*

- *Landscape Guide for Vermont Roadways & Transportation Facilities*, Vermont Chapter of the American Society of Landscape Architects, Vermont Agency of

Transportation, Montpelier, VT; 2001.

- *Trails for the Twenty-First Century*, 2nd Edition, Rails-to-trails Conservancy, Washington, DC; 2001.
- *Designing Sidewalks and Trails for Access, Part II, Best Practices Design Guide*, Federal Highway Administration, Washington, DC; 2001.
- *Outdoor Lighting Manual for Vermont Municipalities*, Chittenden County Regional Planning Commission, Essex Junction, VT, 1996.

CHAPTER 10



# Maintenance

## *Contents*

10.1	Introduction .....	10-2
10.2	Responsibility .....	10-2
10.3	Design with an Eye Toward Maintenance .....	10-3
10.4	Management Plans .....	10-4
10.5	General Maintenance Considerations.....	10-5
10.5.1	Snow Removal.....	10-5
10.5.2	Sweeping .....	10-5
10.5.3	Surface Repairs .....	10-6
10.5.4	Resurfacing.....	10-6
10.5.5	Signs and Pavement Markings .....	10-7
10.5.6	Utility Cuts .....	10-7
10.5.7	Vegetation .....	10-7
10.5.8	Drainage.....	10-7
10.5.9	Amenities and Miscellaneous Items .....	10-8
10.6	Special Considerations for Sidewalks .....	10-8
10.7	Special Considerations for Shared use Paths .....	10-8



## 10.1 *Introduction*

Like all transportation infrastructure, pedestrian and bicycle facilities are subject to debris accumulation, surface deterioration, and other maintenance issues that can limit their functionality if not addressed. Maintenance protects the investment of public funds in pedestrian and bicycle facilities, so they can continue to be used safely. Poorly maintained facilities become unusable and a potential legal liability, as bicyclists and pedestrians who continue to use them may risk personal injury and equipment damage. Others will choose not to use the facilities at all.

Every agency, municipality or organization that is responsible for maintaining a facility should establish maintenance standards, identify how users should report maintenance needs, and prioritize special activities such as snow clearing and debris removal. Maintenance inspections should be routinely performed in combination with a spot improvement program (discussed in more detail below).

Consider costs and responsibility for maintenance when projects are planned and budgets are developed. **A good rule of thumb is that 3-5 percent of infrastructure replacement costs should be spent on annual maintenance.** For example, if a facility costs \$100,000 to construct, \$5,000 should be budgeted for its maintenance each year. Preventive maintenance reduces hazards and future repair costs. Life cycle cost analysis can be used to evaluate expenditures, such as the net value of using a higher quality, longer-lasting material initially.

It is essential that maintenance considerations be considered during the planning and design stages of a project to ensure that a capable maintenance entity is identified and the full cost of maintenance activities are considered before embarking on the types of improvements described in this manual.

The primary goal of a maintenance program should be to ensure that a facility serves its original purpose. **The following actions will help ensure that adequate maintenance takes place:**

- *Develop written maintenance procedures and follow them.*
- *Develop an inspection and maintenance checklist.* Periodic inspections that identify problem areas are an essential feature of any maintenance program. The frequency of inspections will vary from region to region and with the nature of the maintenance activity. The adoption of an inspection and maintenance checklist outlining possible problems and appropriate solutions will help ensure adequate maintenance and repair of facilities.
- *Regularly monitor/inspect facilities.* Inspect facilities regularly using trained and experienced maintenance personnel. Investigate reports of hazards.
- *Keep a report of maintenance activities and inspections.* Such records may become significant in liability actions that may take place at a later date.

## 10.2 *Responsibility*

Although the state may assist with funding and development of sidewalks and shared use paths, maintenance of these facilities often remains a municipal responsibility. The VTrans' Sidewalk Policy requires that there be an agreement between

the Agency and the municipality where a sidewalk will be built identifying the municipality responsible for all maintenance, including (but not limited to) winter snow and ice removal when deemed appropriate.

Because on-road bicycle facilities (bicycle lanes, wide curb lanes and paved shoulders) are an extension of the road surface, they should receive the same level of maintenance as the rest of the road and will require less specialized maintenance.

In communities where the Department of Corrections has work crews available, it may be possible to have some maintenance done by this agency.

Management of some rail-trails in Vermont is a joint effort between the Vermont Department of Forests, Parks and Recreation (FP&R) and the Vermont Agency of Transportation. Because the trails are on state lands, FP&R, as the state's natural resource management agency, is a logical management entity. However, FP&R and VTrans have limited resources for land management and maintenance. A plan for maintenance and funding sources should be included in the planning process for rail-trail development. In most cases, funding may be derived from a consortium of trail users, host communities, and the state.

### *10.3 Design With an Eye Toward Maintenance*

Designers should take into account what effects their design will have on long-term maintenance and management of the project. Designers should also consider the perspectives of all potential facility users, visit other projects, seek innovative solutions to address specific design issues, strive for simplicity, and monitor the successes and failures of similar projects as they develop.

General principles to consider when designing with an eye toward maintenance include:

- Working with adjacent property owners in advance will result in fewer problems and better solutions.
- Expect vandalism.
- Consider the range of potential uses and user groups.
- Optimize use of existing infrastructure including park-and-ride lots, trail-friendly businesses and neighbors.
- Use common sense. Keep the design simple.

#### **Materials and Techniques**

Consider the characteristics of all facility users, their equipment and the potential impact of the equipment upon the facility. In choosing materials:

- Use locally available materials where possible to ease and speed repair and replacement.
- Avoid mechanical parts that may rust, corrode, loosen or break.
- Use durable materials.
- Provide adequate base materials to increase the longevity of paved surfaces.
- Plant landscaping a sufficient distance from facilities to minimize encroachment problems.

#### **Consider Maintenance Equipment**

Off-road facilities should be designed and built to a standard that allows appropriate maintenance equipment to access and service the facility without damaging it. The dimensions of shared use paths should consider the width, turning radii and weight of the equipment expected to maintain the facility.



*The regional planning entities should work with VTrans District Administrators and local bicycle groups to identify hazards and opportunities for maintenance improvements. Within funding constraints, as a part of regular maintenance activities, VTrans District Administrators should routinely inspect and maintain roadway and shoulder surfaces. There are about 6,500 miles of paved roadway surface in Vermont. Although the state has responsibility for maintaining a considerable portion of these roads, about 3,900 miles (or 60 percent) are the responsibility of the municipalities. For this reason, municipalities should also be encouraged to maintain their pavements and shoulders to accommodate bicyclists and pedestrians.*

— *Bicycle and Pedestrian Plan*, Vermont Agency of Transportation, December 1998

### Wildlife Impacts

Anticipate unexpected problems with wildlife access (i.e., nesting turtles in gravel path surfaces, snakes on stone surfaces, and animal waste from wild and domestic animals). Leave frequent openings in fencing (at natural crossing locations) to ensure that wildlife may safely cross a facility.

## 10.4 Management Plans

Especially for shared use paths and rail trails, a management plan is a useful tool to identify maintenance needs and responsible parties. It is recommended that development of a management plan with a maintenance component occur before the trail is constructed. Path managers should recognize that adjustments to the plan might be needed when the facility becomes operational. While maintenance issues are a key component of a management plan, other items, such as resolving user conflicts, can be addressed.

Items to address in a management plan include:

- Basic operational and staffing questions such as: Who opens and closes gates? Fills potholes? Removes downed or dangerous trees? Responds to vandalism and trespass? Removes litter? Replaces stolen or damaged signs? Waters and weeds landscaping? Acts as the main contact? Does the work? Pays the bills?
- What services will and will not be available on the trail? What happens to trail users when they leave the trail to access local services?
- Addressing how funding generated from leases and easements can be used for trail maintenance.

For maintenance items, include:

- The frequency of maintenance tasks.
- The types of materials to be used.
- The standards for successful accomplishment of tasks.
- The total resources needed including man-hours.
- An estimate of cost for each activity.

Additionally, some communities have initiated adopt-a-path or trail programs where civic groups or other organizations can “adopt” a segment of path, trail or bicycle route and take responsibility for routine maintenance. If instituting an adopt-a-path program, the responsibilities of the organization adopting the facility should be clearly spelled out.

### Spot Improvement Programs

Responsible entities may wish to create an ongoing spot improvement program. Soliciting comments from users can help an agency find specific problem locations. Institutionalizing this process, in the form of a user-requested “spot improvement program,” can provide ongoing input and, in many cases, help identify problems early. In addition, such a program can dramatically improve the relationship between an agency and the public.

Spot improvement request forms can be created as mail-in post cards and be made available at municipal buildings, bike shops, libraries, etc., and can be filled out and submitted to local authorities. Simple requests like filling potholes or sweeping, are usually handled on a routine basis. On paths or rail trails, they can be located at path and trailside facilities and at information kiosks. An important ele-

Brunswick, ME



Look for opportunities to acknowledge civic groups or other organizations that “adopt” trails and share maintenance responsibilities.

Enosburg Falls – Missisquoi Valley Rail Trail



Trailside comment stations provide opportunities to solicit feedback from trail users and help agencies find specific problem locations.

ment of a spot improvement program is to identify the funding and personnel who will be responsible for responding to requests prior to soliciting these from the public.

## 10.5 General Maintenance Considerations

There are a number of maintenance activities that are common to all pedestrian and bicycle facilities.

### 10.5.1 Snow Removal

When it is expected that a facility will be used during winter months, snow removal must be planned for. It should be expected that pedestrian facilities would be used year-round. Shared use paths may be used for winter activities like cross-country skiing or snowmobiling. In those cases, snow removal is not a consideration. However, some shared use paths are kept clear of snow so that walking, jogging and bicycling can occur year-round. Even in winter, some experienced bicyclists, usually in urban areas, use a bicycle for commuting. Snow should be placed well out of the portion of the travel lane that bicyclists use.

Snow and ice buildup will inhibit wintertime use of walkways. Walkways and curb ramps should not be used as snow storage areas for snow removed from streets. Local policies should treat the clearance of snow from walkways as being of equal importance as clearance of snow from streets. In areas where abutting landowners and residents are responsible for clearing walkways, local regulations should be enforced.

Give special attention to snow removal from shoulders. Frequently, and for a variety of reasons, more people tend to walk when there are snow conditions. In areas with no sidewalks (or where sidewalks are not cleared in a timely manner), pedestrians will walk on the shoulder or on the roadway. Snow removal programs should call for providing a clear shoulder just as they do for travel lanes on the roadway. Further, care must be taken not to reduce sight distance at intersections and corners by piling snow too close to the walkway.

### 10.5.2 Sweeping

Loose sand and debris on the surface of sidewalks, paved shoulders, bicycle lanes and paved sections of shared use paths should be removed at least once a year, normally in the spring. Bicyclists ride close to the right-hand edge of the roadway, where tires and air movement of moving traffic are most likely to “sweep” the roadway surface free of sand and debris. Even so, pay close attention to this area, especially along designated bicycle routes or on bicycle lanes.

Winter sanding usually leaves a coating of material on sidewalks at the end of the winter season. Sidewalks should be swept and the debris removed. Where the abutting landowners and residents bear this responsibility, enforce local regulations to clean walkways.

Where bicycle lanes are provided, passing motor vehicles may not be as likely to sweep these lanes free of debris and may actually increase the amount of debris on the bicycle lanes. This can be especially true for bicycle lanes that are located directly adjacent to a curb, where debris tends to collect against the curb. Keeping bicycle lanes well maintained becomes especially important. Otherwise, bicyclists may choose to ride in the vehicle travel lanes, defeating the purpose of providing extra space for bicyclists.



Because pedestrian facilities will be used year-round, local policies should treat the clearance of snow from walkways as equal importance as clearance of snow from streets.



Because bicyclists ride close to the right-hand edge of the roadway, it is important to remove debris that collects against a curb face on a regular basis.

### 10.5.3 Surface Repairs

Bicyclists and pedestrians are more sensitive to problems in the roadway surface than motor vehicles. Small bumps and cracks that are barely noticeable to motor vehicles can cause a bicycle to crash or swerve or make walking difficult, especially for pedestrians with disabilities. Over time sidewalks can develop uneven surfaces and cracks. Sections of walkway with a vertical differential of greater than 13 mm (0.5 in.) should be replaced or repaired temporarily with asphalt. In locations with a high volume of pedestrian traffic, especially wheelchair users, any differential larger than 7 mm (0.25 in.) should be repaired. Separated expansion joints between adjoining sections of sidewalk should be no greater than 13 mm (0.5 in.). The gap can be filled with hardening expansion compound.

Sidewalks and shared use paths can also be cracked and heaved by tree roots. Failed sections of concrete sidewalk should be removed, the roots cut and new sections of sidewalk installed. Where the roots have heaved an asphalt sidewalk or path, the surface repair should extend over the full width of the facility to minimize future problems due to possible differential settling. If the roots to be removed are large, contact an arborist to determine how to lessen the possibility of injuring the tree. Transition problems can result from previous repairs. Where the pavement surface from a prior repair has deteriorated, become cracked, or is missing altogether, remove the transition section and have all defective sections of pavement replaced.

### 10.5.4 Resurfacing

Pavement overlays are an excellent opportunity to improve conditions for bicyclists. Care should be taken to avoid leaving a ridge in a shoulder or bicycle lane. The overlay should be extended over the entire roadway surface, if possible. If not, the overlay should end at the shoulder or bicycle lane stripe, provided an abrupt transition is not created.

Chip seals or placing pavement grindings to surface or resurface shoulders should not be used, as it will render the shoulder area unusable by most bicyclists.

Utility covers and drainage grates should be raised to within 6 mm (1/4 in.) of the pavement surface, and grates should be bicycle-safe grates (refer to Section 4.7.1, Drainage and Drainage Grates). Gravel driveways and alleys should be paved back 3.0 m (10 ft) from the edge of the roadway, path or sidewalk to help prevent gravel from spilling onto the facility.

Care should also be taken to raise the level of adjacent unpaved compacted shoulders so they are flush with the new roadway surface, as a vertical drop onto a low shoulder can cause a bicyclist trying to ride back onto the roadway to fall into the path of overtaking vehicles.

One potential problem with resurfacing occurs when a road has been constructed over an old concrete roadbed that remains in place beneath the existing paved surface. In most cases, the old roadbed is much narrower than the current paved roadway and because of differential settling between it and adjacent material, surface cracking occurs on the paved surface. These longitudinal cracks typically appear from 0.3 - 0.6 m (1 - 2 ft) in from the edge line of the road, which is where bicyclists normally ride. Bicyclists are therefore forced to cross over the crack to use a shoulder, if one is available, or to ride in the travel lane.

There are several methods for addressing old concrete roadbeds. The most expensive and labor intensive is to excavate and completely remove the concrete, which essentially requires full-depth reconstruction of the entire road. Most of the other



Small bumps and cracks that are barely noticeable to motor vehicles can cause a bicycle to crash or swerve.



When roads are resurfaced, raise the level of the adjacent unpaved shoulder flush with the new roadway surface. Otherwise, a vertical drop onto a low shoulder can cause a bicyclist trying to ride back onto the roadway to fall into the path of overtaking vehicles.

East St. Johnsbury



When resurfacing occurs over old concrete roadways, longitudinal cracks may appear where bicyclists normally ride.



methods attempt to make the area adjacent to the old roadbed act similarly to the roadbed. This results in a more consistent overall cross section and lessens the amount and extent of surface cracking. The various alternatives are listed below in increasing order of expense and effectiveness. The different alternatives for achieving this include:

1. Crack and seat the slabs, which breaks them into smaller pieces that move more like adjacent material.
2. Rubblize the slabs, which breaks them into aggregate size pieces that mimic adjacent material.
3. Excavate the material adjacent to the slabs and replacing it with aggregate and pavement that replicates the stiffness of the concrete
4. Extend the existing concrete slabs to the full roadway width
5. Place a stiff fabric, such as asphalt impregnated fiberglass, on the outside portion of the roadway, overlapping the area that overlays the old roadbed. This provides the lowest level of relief and often only delays the cracking.

### 10.5.5 Signs and Pavement Markings

Signs and pavement markings are important features of roadways and shared use paths and need to be maintained and inspected regularly. A regular inspection of bicycle facilities should include an inventory of signs to account for missing signs or damaged signs. Similarly, striping should be inspected and reapplied as needed. In some cases, striping may be visible, but has lost its slip resistance, which can be a hazard to bicyclists. A regular inspection of the condition of paint on crosswalks and stop bars should be conducted and re-application should occur if necessary.

Inspect pedestrian signals periodically for proper operation; clean lenses and replace bulbs as necessary.

One method of sign management is to place a numbered tag on each sign so routine patrols can identify which ones are missing. This technique can be expanded to produce a facility map that shows the tag number and location of each sign, kiosk, mile marker, culvert, picnic table, sign-in box, bench, etc. along a facility.

### 10.5.6 Utility Cuts

Utility cuts can leave uneven surfaces for bicyclists and pedestrians if they are not backfilled and replaced correctly. Cuts should be backfilled and compacted so that the cut will be flush with the existing surface when completed. For bicycle facilities, care should be taken to avoid cuts that are parallel to the direction of bicycle traffic, if possible. Such cuts can result in uneven edges or grooves that can be a problem for bicyclists.

### 10.5.7 Vegetation

Vegetation may encroach onto bicycle or pedestrian facilities by either growing into the travel path of bicyclists or pedestrians or growing in cracks and causing deterioration of the surface. Regular inspection and maintenance can address this issue. Local regulations that require abutting land users to perform timely clearance of vegetation that becomes an obstruction or limits sight distance should be enacted and enforced. As an alternative, private contractors can be hired to clear vegetation and the costs assessed to abutting landowners.

### 10.5.8 Drainage

Standing water problems can hinder the use of bicycle and pedestrian facilities. Some of these problems are created by either the design or construction of a facility,



Regularly inspect and repaint crosswalk markings as required.



Backfill and compact utility cuts so that the cut will be flush with the existing surface.



Remove uneven edges and grooves around utility covers and utility cuts.



Clear vegetation that encroaches upon or restricts the use of a pedestrian walkway.

but some are related to maintenance. Common maintenance problems are clogged drainpipes or inlets. On sidewalks, ponds at curb ramps can be especially problematic for persons with disabilities. Where ponding occurs in bicycle lanes or on shoulders, bicyclists may be forced to swerve into adjacent travel lanes. Maintenance should occur on drainage grates and swales around curb inlets to ensure that they are functional, free of debris, and level with the pavement.

### 10.5.9 Amenities and Miscellaneous Items

There are a number of ancillary items associated with bicycle and pedestrian facilities that also will require an ongoing maintenance program. The following maintenance activities should be considered:

- Keep lights clean and replace fixtures as required.
- Maintain support facilities such as benches and drinking fountains.
- Pick up litter and empty trashcans.
- Repair sections of broken or missing fencing, especially on bridges or other locations where it serves as a barrier to protect pedestrians and bicyclists from adjacent hazards.



Provide positive drainage away from the base of curb ramps. Water that is allowed to accumulate at the base of a curb ramp can freeze during winter and render the ramp unusable by people with disabilities.

Cavendish



Repeated pavement overlays adjacent to curbed sidewalks can result in standing water and promote vehicles parking on the sidewalk.

## 10.6 Special Considerations for Sidewalks

In addition to the maintenance activities expected for all bicycle and pedestrian facilities, sidewalks may include the following needs:

- *Newspaper stands, portable signs, and other devices creating barriers on a sidewalk*. The responsible parties should be required to remove any obstructions from the pedestrian through zone (refer to Chapter 3, Pedestrian Facilities).
- *Worn or slippery steps or ramp surfaces*. Steps and ramp surfaces that are worn and slippery should be overlaid, textured, or replaced to create a slip-free and unbroken surface.
- *Snow and slush removal from curb ramps*. Extra effort may be required to remove accumulated snow and slush from the base of curb ramps. If this material is not removed, it can freeze and render the ramps unusable by persons with disabilities and other users.
- *Pavement overlays adjacent to curbed sidewalks*. Repeated pavement overlays adjacent to curbed sidewalks eventually result in the loss of the original curb reveal. This can result in standing water on sidewalks, vehicles parking on sidewalks and loss of vertical separation between sidewalks and adjacent roadways. Normally one overlay can be performed while maintaining adequate curb reveal. The preferred technique is to mill off existing surfaces and replace with the same depth of material, thus maintaining curb reveal.

## 10.7 Special Considerations for Shared Use Paths

In addition to the maintenance activities expected for all bicycle and pedestrian facilities, plan for the following on shared use paths:

- Remove debris along the path and animal waste at agricultural crossings
- Plan for the installation and removal of seasonal signing and other items if different user groups are expected in the winter.
- Place and remove plank runners on bridge decks to accommodate seasonal snowmobile use.

- Where paths are plowed, completely clear snow from the path edge. Where snow is not cleared from path edges, additional moisture and frost problems can occur.
- Locate fences and barriers away from paths to facilitate snow removal.



APPENDIX A



# Glossary

## Glossary

The information provided in this section is intended to aid the users of this manual in understanding the terms and concepts presented throughout the Manual. The definitions are not intended to represent or replace the official formal definitions. However, where the definitions vary from those contained in Vermont State Statutes (VSA) the VSA definition is also noted.

**AADT** – Average annual daily traffic. The total yearly traffic volume in both directions of travel divided by the number of days in the year.

**AASHTO** – American Association of State Highway and Transportation Officials.

**ADA** – The Americans with Disabilities Act of 1990. A Federal law prohibiting discrimination against people with disabilities.

**ADAAG** – Americans with Disabilities Act Accessibility Guidelines (1991). Provides technical specifications for new construction and alterations of buildings and facilities undertaken by entities covered by the ADA.

**ADT** – Average daily traffic. The traffic volume in both directions of travel in a time period divided by the number of days in that time period.

**ANR** – Vermont Agency of Natural Resources.

**Arterial Street** – Divided or undivided, relatively continuous routes that primarily serve through traffic, high traffic volumes and long average trip lengths. Traffic movement is of primary importance, with abutting land access of secondary importance. Arterials include expressways without full control of access; U.S. numbered routes and principal state routes. May be classified as urban or rural.

**Bicycle** – Every vehicle propelled solely by human power upon which any person may ride, having two tandem wheels, except scooters and similar devices. The term “bicycle” in this manual also includes three- and four-wheeled human-powered vehicles, but not

tricycles for children. VSA: “Bicycle” means every pedal-driven device propelled by human power having two or more wheels on which a person may ride, including a so-called pedal vehicle which may have an enclosed cab.

**Bicycle Facilities** – A general term denoting improvements and provisions to accommodate or encourage bicycling, including parking and storage facilities, shared-use paths and shared roadways not specifically designated for bicycle use.

**Bicycle Lane (or Bike Lane)** – A portion of the roadway that has been designated by striping, signing and pavement markings for the preferential or exclusive use of bicyclists. VSA: “Bicycle lane” means a portion of a roadway which has been designated for the preferential or exclusive use of bicycles. It is distinguished from the portion of the roadway for motor vehicle traffic by a paint stripe or similar device. Paved road shoulders are considered bicycle lanes.

**Bicycle Route** (designated bicycle route) – A right-of-way selected to provide bicyclists with direct, preferred and/or scenic course of travel to specific or general destinations. Bicycle routes may be coincident with bicycle facilities such as shared use paths, bike lanes, wide curb lanes, paved shoulders or a shared roadway. To convey the intended course of travel to bicycle users, bicycle routes are usually identified (or “designated”) by signs and can be supplemented by maps. VSA: “Bicycle route” means any lane, way, or path, designated by appropriate signs, that explicitly provides for bicycle travel.

**Bikeway** – A generic term for any road, street, path or way which is designated for bicycle travel, regardless of whether such facilities are designated for the exclusive use of bicycles or are to be shared with other transportation modes.

**BPAC** – Bicycle and Pedestrian Advisory Committee. A volunteer committee representing various user groups, appointed by the state and coordinated within the state bicycle and pedestrian program, for the

purpose of institutionalizing a public process for bicycle and pedestrian program development.

**CBD** – Central Business District. A traditional downtown or village area usually characterized by established mixed use businesses fronting the street, sidewalks, slow traffic speeds, on-street parking and a compact grid system of streets.

**Clearance, Vertical** – The height required for safe passage as measured in a vertical plane.

**Collector Street** – A street designated to carry traffic between local streets and arterials, or from local street to local street where mobility and access are equally important.

**Cross Section (also Typical Cross Section or Typical)** – A diagrammatic representation of a highway or path that is at right angles to the centerline at a given location.

**Crosswalk** – That part of a roadway at an intersection included within the connections of the lateral lines of the sidewalks on opposite sides of the highway measured from the curbs or, in the absence of curbs, from the edges of the traversable roadway. In the absence of a sidewalk on one side of the roadway, that part of a roadway included within the extension of the lateral lines of the existing sidewalk at right angles to the centerline. Also, any portion of a roadway at an intersection or elsewhere distinctly indicated for pedestrian crossing by lines or other markings on the surface. VSA: (A) That part of a roadway at an intersection included within the connections of the lateral lines of the sidewalks on opposite sides of the highway measured from the curbs or, in the absence of curbs, from the edges of the traversable roadway; (B) Any portion of a roadway at an intersection or elsewhere distinctly indicated for pedestrian crossing by lines or other markings on the surface.

**Design Speed** – The maximum safe speed that can be accommodated over a specified section of a bicycle facility based upon its design features.

**Disability** – With respect to an individual, a physical or mental impairment that substantially limits one or more of the major life activities of such individual; a record of such an impairment; or being regarded as having such an impairment.

**Edge Line (also Fog Line)** – A painted or applied line to designate the edge of the roadway, normally white in color.

**Edge of the Roadway** – VSA: The extreme right-hand limit of any improved area within the right of way of the highway.

**DHV** – Design hourly volume. The one-hour traffic volume in both directions of travel in the design year selected for determining the highway design, typically the 30<sup>th</sup> highest hourly volume within the design year.

**Grade** – A measure of the steepness of a roadway, bikeway or sidewalk, expressed as a ratio of vertical rise per horizontal distance, usually in percent. For example, a 5 percent grade equals a 5-unit rise over a 100 unit horizontal distance.

**Grade Separation** – The use of overpasses and tunnels to physically separate facilities such as railroads and roadways.

**Guidelines** – Advisory actions or requirements, considered to be recommended but not mandatory.

**Heavy Vehicle** – A truck, bus or recreational vehicle with more than four tires.

**Highway** – The entire width between the boundary lines of every publicly maintained way when any part thereof is open to the use of the public for vehicular travel. (Refer to Figure A-1.) VSA: “Highway,” “public highway” or “public road” shall include all parts of any bridge, culvert, roadway, street, square, fair-ground or other place open temporarily or permanently to public or general circulation of vehicles, and shall include a way laid out under authority of law.

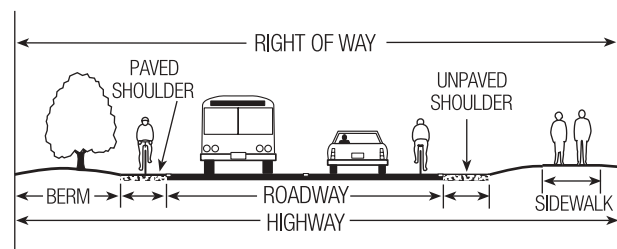

Figure A-1

**ISTEA** – Intermodal Surface Transportation Efficiency Act of 1991. Federal legislation that guided the expenditure of federal highway funds from 1991 through 1997, which was replaced by TEA-21 in 1998.

**Limited Access Highway** – A highway where the right of owners or occupants of abutting land or other persons to access, light, air, or view in connection with the highway is fully or partially controlled by public authority.

**Glossary**

**Local Street** – A street designated to provide access to and from residences and businesses.

**Motor Driven Cycle** – Every motorcycle, motor scooter or motorized bicycle having an engine with less than 150 cubic centimeters displacement or with five brake horsepower or less.

**Motor Vehicle** – VSA: All vehicles propelled or drawn by power other than muscular power, except tractors used entirely for work on the farm, vehicles running only upon stationary rails or tracks, motorized highway building equipment, road making appliances, snowmobiles, all-terrain vehicles or implements of husbandry, or tracked vehicles.

**Motorized Wheelchair** – Any self-propelled vehicle incapable of a speed in excess of 8 miles per hour designed for, and used by, a person with disabilities.

**MPO** – Metropolitan Planning Organization.

**MUTCD** – Manual on Uniform Traffic Control Devices. The national standard, approved by the Federal Highway Administration and incorporated in Vermont law, for selection and placement of all signs, pavement markings and traffic signals on or adjacent to all highways open to public travel.

**Path (or Pathway)** – a trail or shared use path.

**Path Width** – The portion of a path provided for the movement of path users, exclusive of shoulders.

**Paved Shoulder** – The portion of a shoulder, which is paved, measured from the center of the edge line.

**Pavement Markings** – Painted or applied lines or legends placed on a roadway surface for regulating, guiding or warning traffic.

**Pedestrian** – A person on foot, walking a bicycle, or using an assistive device, such as a wheelchair, for mobility.

**Pedestrian Facilities** – A general term denoting improvements to accommodate or encourage walking, including sidewalks, crosswalks, signs, signals, or benches.

**Posted Speed** – The legal speed limit assigned to a segment of highway by the State Traffic Committee (in the case of a state highway) or the local Selectboard (in the case of a town or municipal road or street).

**Rail Trail** – A shared use path, either paved or unpaved, built within the right-of-way of an abandoned former railroad.

**Rail With Trail** – A shared use path, either paved or unpaved, built within the right-of-way of an active railroad.

**Right of Way** – A general term denoting land, property, or interest therein, usually in a strip, acquired for or devoted to transportation purposes. Also, the right of one vehicle or pedestrian to proceed in a lawful manner in preference to another vehicle or pedestrian.

**Roadway** – That portion of a highway improved, designed or ordinarily used for vehicular traffic, exclusive of the sidewalk, or shoulder even though such sidewalk, or shoulder is used by persons riding bicycles or other human powered vehicles. (Refer to Figure A-1.) VSA: “Roadway” is that portion of a highway improved, designed or ordinarily used for vehicular traffic, exclusive of the shoulder.

**Roundabout** – Circular intersection with specific design and traffic control features including yield control for entering traffic, channelized approaches, and appropriate geometric curvature to ensure travel speeds less than 48 km/h (30 mph).

**RPC** – Regional Planning Commission.

**3R Project** – Specific roadway improvement projects that include resurfacing, restoration and rehabilitation of the roadway.

**RTC** – Rails-to-Trails Conservancy.

**Rules of the Road** – The portion of state motor vehicle law that contains regulations governing the operation of vehicular, bicycle and pedestrian traffic.

**Rumble Strips** – A textured or grooved pavement treatment sometimes used on or along shoulders to alert motorists who stray onto the shoulder.

**Shared Roadway** – A roadway which is open to both bicycle and motor vehicle travel where bicyclists and motor vehicles share a travel lane regardless of whether such facility is specifically designated.

**Shared Use Path** – a path physically separated from motorized vehicular traffic by open space or a barrier and either within the highway right-of-way or within an independent right-of-way. Shared use paths typically permit more than one type of user, such as pedestrians, joggers, people in wheelchairs, skaters, bicyclists, cross-country skiers, equestrians and snowmobilers. An equestrian-only or pedestrian-only trail is not a shared-use path.



**Shoulder** – The improved paved or unpaved portion of a highway contiguous with the roadway provided for the accommodation of pedestrians, bicyclists, stopped vehicles, emergency use and lateral support of sub-base, base and surface courses.

**Shoulder Bikeway** – A type of bicycle facility where bicyclists travel on a paved shoulder.

**Shy Distance** – The distance that an individual or vehicle tends to “shy away” from an object which is perceived as hazardous.

**Sidewalk** – VSA: The portion of a street between the curb lines or the lateral lines of a roadway, and the adjacent property lines, intended for use by pedestrians.

**Sight Distance** – The distance a person can see along an unobstructed line of sight.

**Signal Face** – The part of a highway traffic signal, which controls one or more traffic movements in a single direction.

**Signal Head** – An assembly of one or more signal faces.

**Signed Shared Roadway (also Signed Bicycle Route)** – a shared roadway, which has been designated, by signing as a preferred route for bicycle use.

**Snowmobile** – VSA: A self-propelled vehicle intended for off-road travel on snow, having a curb weight of not more than 453.59 kg (1,000 lbs.); driven by track or tracks in contact with the snow and steered by a ski or skis in contact with the snow.

**Standards** – Mandatory requirements or conditions to be met. Deviations from minimum standards are allowed as outlined in the VTrans Design Exception Policy.

**State Highway** – A highway maintained exclusively by the Vermont Agency of Transportation.

**Street (see Highway)** – The entire width between the boundary right of way lines of every publicly maintained way when any part thereof is open to the use of the public for vehicular travel.

**Structure** – A bridge, retaining wall, tunnel or large culvert.

**TEA-21** – Transportation Efficiency Act for the 21<sup>st</sup> Century. Federal legislation that guides the expenditure of federal highway funds from 1998 through 2002, replaced ISTEA.

**Town Highways** – VSA: Those highways exclusively maintained by the towns and those highways maintained by the towns except for scheduled surface maintenance performed by the agency pursuant to Section 306a VSA Title 19.

**Traffic Calming** – A combination of mainly physical measures that reduce the negative effects of motor vehicle use, alter driver behavior and improve conditions for non-motorized street users.

**Traffic Control Device** – Sign, signal, pavement marking or other fixture, whether permanent or temporary, placed on or adjacent to a traveled way by authority of a public body having jurisdiction to regulate, warn or guide traffic.

**Traffic Volume (see ADT)** – The given number of vehicles that pass a given point for a given amount of time (hour, day, year).

**Trail** – a path of travel within a park, natural environment or designated corridor when the corridor is not classified as a highway, road or street.

**Traveled Way (also Travel Way or Travel Lane)** – The portion of a roadway provided for the movement of vehicles, exclusive of shoulders.

**Unpaved Path** – A pathway not surfaced with asphalt or Portland cement concrete.

**Urban Area** – The area immediately surrounding an incorporated city or rural community that is urban in character, regardless of size.

**VAST** – Vermont Association of Snow Travelers.

**Vehicle** – Every device in, upon or by which any person or property is or may be transported or drawn upon a highway, including vehicles that are self-propelled or powered by any means and excepting devices used exclusively upon stationary rails or tracks.

**VTrans** – Vermont Agency of Transportation.

**Walkway** – A transportation facility built for use by pedestrians, including persons in wheelchairs. Walkways include sidewalks, paths and paved shoulders.

**Wide Curb Lane (also Wide Outside Lane)** – A wide travel lane adjacent to a curb, parking lane or shoulder provided for ease of bicycle operation where there is insufficient room for a bike lane or shoulder bikeway.



APPENDIX B



# AASHTO Interstate Bicycle Route Numbering Policy

*AASHTO Interstate Bicycle Route Numbering Policy*

## *AASHTO Interstate Bicycle Route Numbering Policy*

The American Association of State Highway and Transportation Officials (AASHTO) has promulgated policy that pertains to numbering interstate bicycle routes.

AASHTO's policy regarding U.S. Number Bicycle Routes is as follows:

*Purpose and Policy, U.S. Numbered Bicycle Routes*

*(Retained from June 30, 1982)*

### **HO3 PURPOSE**

The purpose of the U.S. bicycle route numbering and marking system is to facilitate travel between the states over routes which have been identified as being more suitable than others for cycling.

### **DEFINITION**

A bicycle route is any road, street, path or way which in some manner is specifically designated as being open to bicycle travel, regardless of whether such facilities are designated for the exclusive use of bicycles or are to be shared with other transportation modes.

### **POLICIES**

1. The Standing Committee on Highways of the American Association of State Highway and Transportation Officials shall have full authority to review the U.S. numbered bicycle route system and the numbering and marking thereof, to make additions, changes, extensions, revisions or reductions in said route system and to revise the numbering or marking thereof.
2. Before approving any addition, change, extension, revision or reduction in the U.S. numbered bicycle route system, or the numbering or marking of any U.S. numbered bicycle route, the Standing Committee on Highways shall consult the State Highway or Transportation Department of the State or States through or within which such addition, change, extension, revision or reduction is located.
3. The State Highway Department, by a favorable vote on the adoption of this purpose and policy, agrees and pledges its good faith that it will not erect U.S. markers on any route without the authorization, consent or approval of the Standing Committee on Highways of the American Association of State Highway and Transportation Officials, notwithstanding the fact that the changes proposed are entirely within that State.
4. No U.S. numbered bicycle route shall be designated that does not extend between two or more States and is mapped and/or appropriately marked along its length.

*AASHTO Interstate Bicycle Route Numbering Policy*

5. The bicycle route marker included in the Manual on Uniform Traffic Control Devices is recommended for use to all travel map makers, also for use by the State Highway and Transportation Departments.
6. Any proposal that would exploit the prestige of the U.S. numbered bicycle route system, especially when it appears to be for the purpose of benefiting businesses located along such a proposed route, shall constitute reason for denying any application to make such an addition to the system.
7. Since the U.S. numbered system was established by joint action of the State Highway or Transportation Departments, only those applications for change in or addition to the U.S. numbered system from the Member State Highway or Transportation Department involved shall be considered by the Standing Committee on Highways. Those local officials, organizations, groups, or individuals interested in a change or in an addition to the system should contact their State Highway or Transportation Department and not the Standing Committee on Highways. The Standing Committee on Highways shall consider only those applications from State Highway or Transportation Departments that are filed on the official form and are complete in all detail to the degree that the Standing Committee on Highways can evaluate the need for an adequacy of the proposed route from the application form submitted and without a representative of the State Highway or Transportation Department appearing before the Committee to supply additional information.
8. No person or group of persons shall be allowed to appear either before the Standing Committee on Highways or its Special Committee on U.S. Route Numbering except in the case of a State Highway or Transportation Department requesting reconsideration of an action by the Executive Committee in regard to an application filed by that Department.
9. In case a proposed change or addition to the U.S. numbered bicycle route system involves two or more States, the proposal shall be given official consideration only when all affected State Highway or Transportation Departments have filed applications to cover the complete proposal.
10. No route should be considered for inclusion in the U.S. numbered system that does not substantially meet the current AASHTO design standards contained in the AASHTO Guide for Development of New Bicycle Facilities.

For further information regarding AASHTO's Bicycle Route Numbering Policy contact: Donna Tamborelli, secretary of AASHTO's U.S. Route Numbering Committee at AASHTO's national offices in Washington, D.C. at (202) 624-5800, or Mr. Ray Zink, Chair of AASHTO's U.S. Route Numbering Committee at: North Dakota DOT, 608 E. Boulevard Avenue, Bismarck, ND 58505-0700, (701) 328-2584 voice, (701) 328-1420 fax.

*AASHTO Interstate Bicycle Route Numbering Policy*

APPENDIX C



# Stopping Sight Distance Tables

AASHTO Guide for the Development of Bicycle Facilities

*Stopping Sight Distance Tables*

# *Stopping Sight Distance Tables*

*AASHTO Guide for Development of Bicycle Facilities*

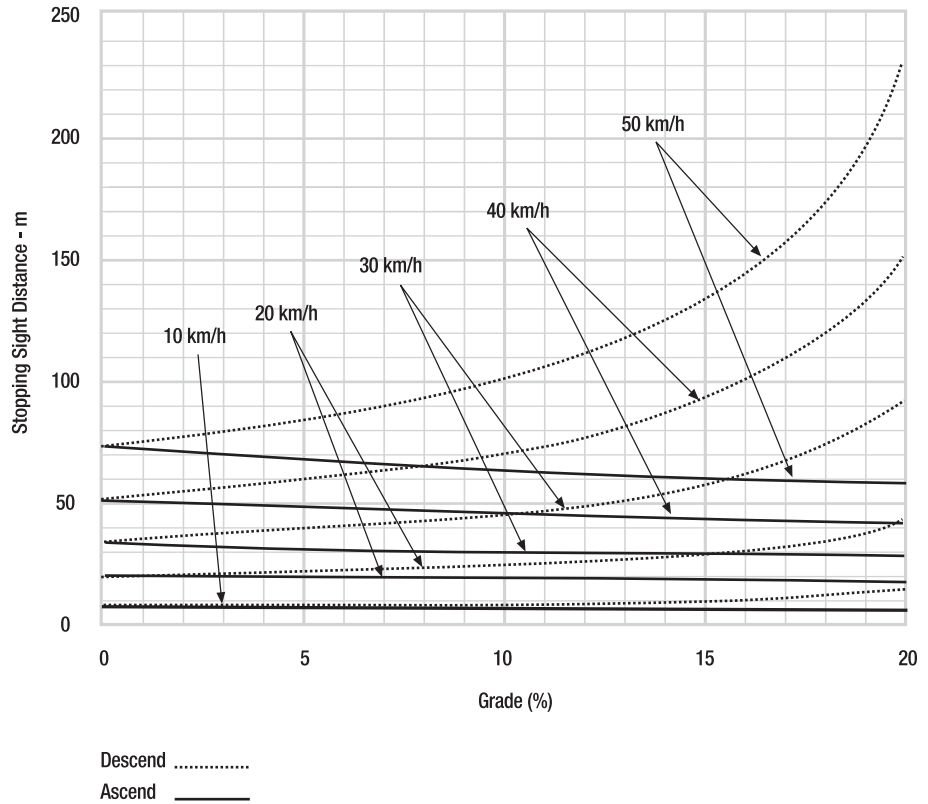

$$S = \frac{V^2}{254 (f \pm G)} + \frac{V}{1.4}$$

Where: S = stopping sight distance (m)  
 V = velocity (km/h)  
 f = coefficient of friction (use 0.25)  
 G = grade (m/m) (rise/run)

Metric Units.  
 Minimum Stopping Sight Distance  
 vs. Grades for Various Design Speeds

From *Guide for the Development of Bicycle Facilities*, Copyright 1999, by the American Association of State Highway and Transportation Officials, Washington, D.C. Used by permission.



*Stopping Sight Distance Tables*

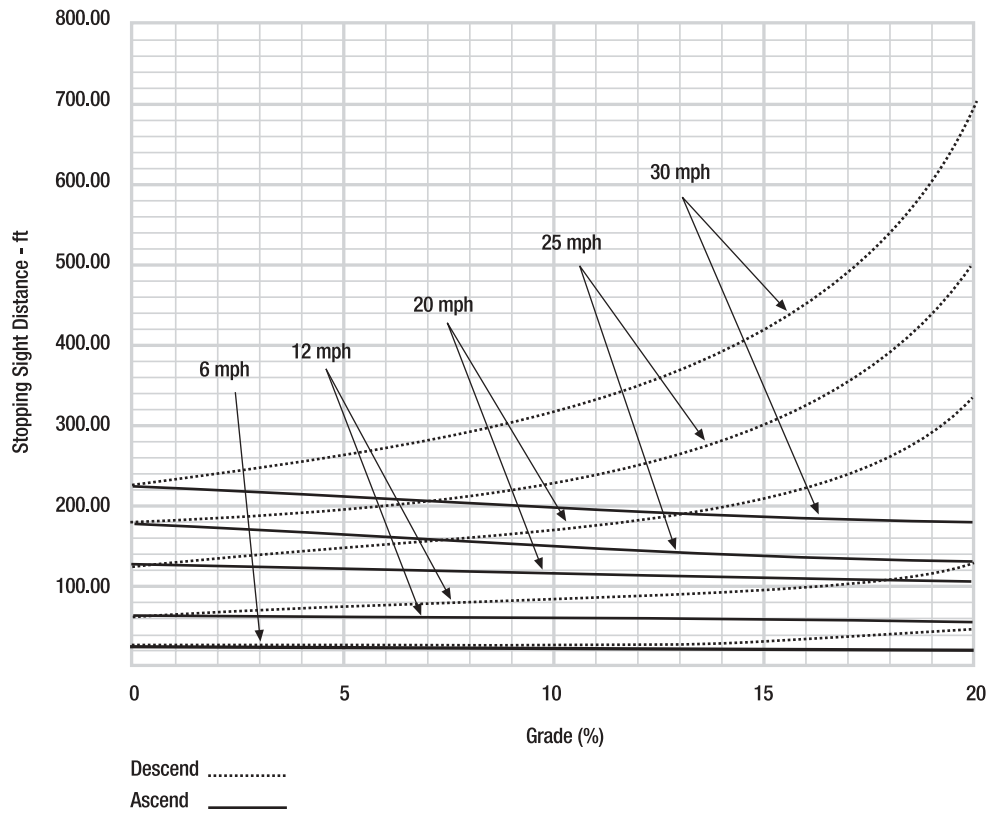

$$S = \frac{V^2}{30(f \pm G)} + 3.67V$$

Where: S = stopping sight distance (ft)  
 V = velocity (mph)  
 f = coefficient of friction (use 0.25)  
 G = grade (ft/ft) (rise/run)

English Units.  
 Minimum Stopping Sight Distance  
 vs. Grades for Various Design Speeds

From *Guide for the Development of Bicycle Facilities*, Copyright 1999, by the American Association of State Highway and Transportation Officials, Washington, D.C. Used by permission.

Stopping Sight Distance Tables

# Stopping Sight Distance Tables

## AASHTO Guide for Development of Bicycle Facilities

Table 3. Metric Units. Minimum Length of Crest Vertical Curve (L) Based on Stopping Sight Distance

A (%)	S = Stopping Sight Distance (m)																		
	10	15	20	25	30	35	40	45	50	55	60	65	70	75	80	85	90	95	100
2														10	20	30	40	50	60
3								7	17	27	37	47	57	67	77	87	97	107	
4							10	20	30	40	50	60	70	80	91	103	116	129	143
5				4	14	24	34	44	54	64	75	88	100	114	129	145	161	179	
6			3	13	23	33	43	54	65	77	91	105	121	137	155	174	193	214	
7			10	20	30	40	51	63	76	90	106	123	141	160	181	203	226	250	
8		5	15	25	35	46	58	71	86	103	121	140	161	183	206	231	258	286	
9		9	19	29	39	51	65	80	97	116	136	158	181	206	232	260	290	321	
10	2	12	22	32	44	57	72	89	108	129	151	175	201	229	258	289	322	357	
11	5	15	25	35	48	63	80	98	119	141	166	193	221	251	284	318	355	393	
12	7	17	27	39	53	69	87	107	130	154	181	210	241	274	310	347	387	429	
13	8	18	29	42	57	74	94	116	140	167	196	228	261	297	335	376	419	464	
14	10	20	31	45	61	80	101	125	151	180	211	245	281	320	361	405	451	500	
15	1	11	21	33	48	66	86	108	134	162	193	226	263	301	343	387	434	483	536
16	3	13	23	36	51	70	91	116	143	173	206	241	280	321	366	413	463	516	571
17	4	14	24	38	55	74	97	123	152	184	219	257	298	342	389	439	492	548	607
18	4	14	26	40	58	79	103	130	161	194	231	272	315	362	411	464	521	580	643
19	5	15	27	42	61	83	109	137	170	205	244	287	333	382	434	490	550	612	679
20	6	16	29	45	64	88	114	145	179	216	257	302	350	402	457	516	579	645	714
21	7	17	30	47	68	92	120	152	188	227	270	317	368	422	480	542	608	677	750
22	7	18	31	49	71	96	126	159	196	238	283	332	385	442	503	568	636	709	786
23	8	18	33	51	74	101	131	166	205	248	296	347	403	462	526	593	665	741	821
24	9	19	34	54	77	105	137	174	214	259	309	362	420	482	549	619	694	774	857
25	9	20	36	56	80	109	143	181	223	270	321	377	438	502	571	645	723	806	893

when  $S > L$      $L = 2S \frac{280}{A}$

Shaded area represents  $S = L$

when  $S < L$      $L = \frac{AS^2}{280}$

L = Minimum Length of Vertical Curve (m)  
 A = Algebraic Grade Difference (%)  
 S = Stopping Sight Distance (m)

Height of cyclist's eye - 1400 mm  
 Height of object - 0 mm

Minimum Length of Vertical Curve = 1 m

From *Guide for the Development of Bicycle Facilities*, Copyright 1999, by the American Association of State Highway and Transportation Officials, Washington, D.C. Used by permission.

*Stopping Sight Distance Tables*

Table 3. English Units. Minimum Length of Crest Vertical Curve (L) Based on Stopping Sight Distance

A (%)	S = Stopping Sight Distance (ft)														
	20	40	60	80	100	120	140	160	180	200	220	240	260	280	300
2												30	70	110	150
3								20	60	100	140	180	220	260	300
4						15	55	95	135	175	215	256	300	348	400
5					20	60	100	140	180	222	269	320	376	436	500
6			10	50	90	130	171	216	267	323	384	451	523	600	
7			31	71	111	152	199	252	311	376	448	526	610	700	
8		8	48	88	128	174	228	288	356	430	512	601	697	800	
9		20	60	100	144	196	256	324	400	484	576	676	784	900	
10		30	70	111	160	218	284	360	444	538	640	751	871	1000	
11		38	78	122	176	240	313	396	489	592	704	826	958	1100	
12	5	45	85	133	192	261	341	432	533	645	768	901	1045	1200	
13	11	51	92	144	208	283	370	468	578	699	832	976	1132	1300	
14	16	56	100	156	224	305	398	504	622	753	896	1052	1220	1400	
15	20	60	107	167	240	327	427	540	667	807	960	1127	1307	1500	
16	24	64	114	178	256	348	455	576	711	860	1024	1202	1394	1600	
17	27	68	121	189	272	370	484	612	756	914	1088	1277	1481	1700	
18	30	72	128	200	288	392	512	648	800	968	1152	1352	1568	1800	
19	33	76	135	211	304	414	540	684	844	1022	1216	1427	1655	1900	
20	35	80	142	222	320	436	569	720	889	1076	1280	1502	1742	2000	
21	37	84	149	233	336	457	597	756	933	1129	1344	1577	1829	2100	
22	39	88	156	244	352	479	626	792	978	1183	1408	1652	1916	2200	
23	41	92	164	256	368	501	654	828	1022	1237	1472	1728	2004	2300	
24	3	43	96	171	267	384	523	683	864	1067	1291	1536	1803	2091	2400
25	4	44	100	177	278	400	544	711	900	1111	1344	1600	1878	2178	2500

when  $S > L$   $L = \frac{2S - 900}{A}$

Shaded area represents  $S = L$

when  $S < L$   $L = \frac{AS^2}{900}$

L = Minimum Length of Vertical Curve (ft)

A = Algebraic Grade Difference (%)

S = Stopping Sight Distance (ft)

Height of cyclist's eye - 4½ ft  
Height of object - 0 ft

Minimum Length of Vertical Curve = 3 ft.

From *Guide for the Development of Bicycle Facilities*, Copyright 1999, by the American Association of State Highway and Transportation Officials, Washington, D.C. Used by permission.

*Stopping Sight Distance Tables*